

# Service Manual

## OPTIMUS PRO Mono (18~30kW)



# CONTENTS

Part 1 General Information.....	3
Part 2 Component Layout and Refrigerant Circuits .....	5
Part 3 Control .....	11
Part 4 Diagnosis and Troubleshooting.....	25



# Part 1

# General Information

1 Unit Capacities and External Appearance ..... 4



# OPTIMUS PRO Mono

## 1 Unit Capacities and External Appearance

### 1.1 Unit Capacities

Table 1-1.1: Capacity range

Capacity	18kW	22kW	26kW	30kW
Model	HOP18WMONO3	HOP22WMONO3	HOP26WMONO3	HOP30WMONO3

### 1.2 External Appearance

Table 1-1.2: Appearance



# Part 2

# Components Layout and Refrigerant Circuits

1 Layout of Functional Components.....	6
2 Piping Diagrams .....	7
3 Refrigerant Flow Diagrams .....	9

# OPTIMUS PRO Mono

## 1 Layout of Functional Components

Figure 2-1.1: HOP18(22,26,30)WMONO3 front view

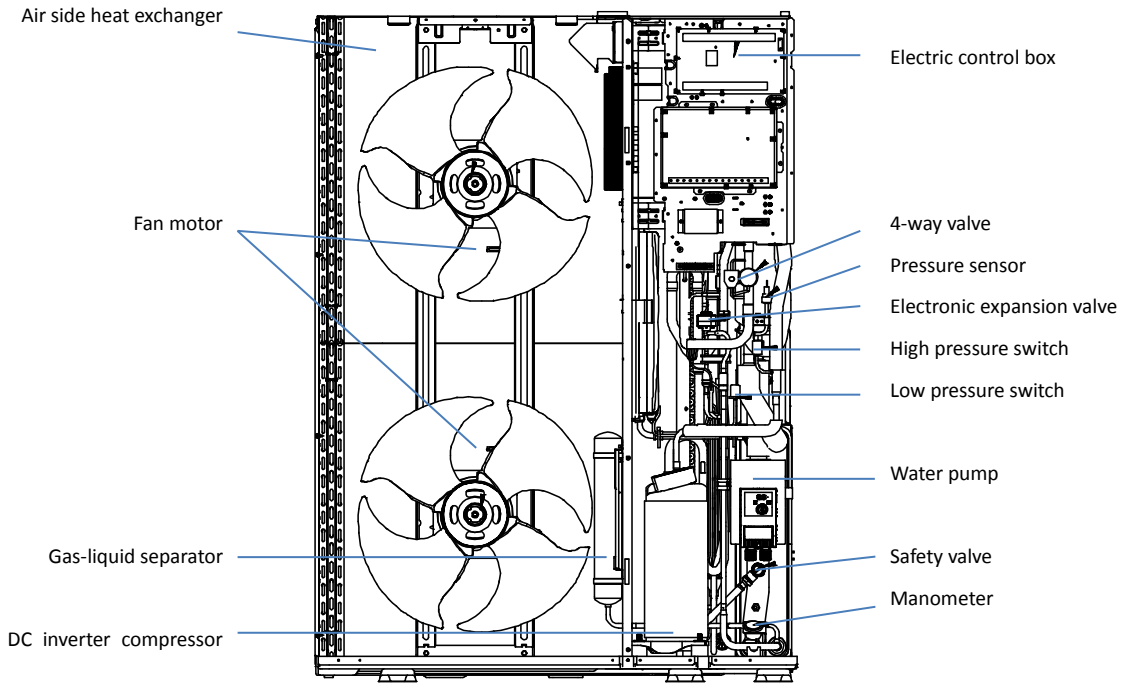
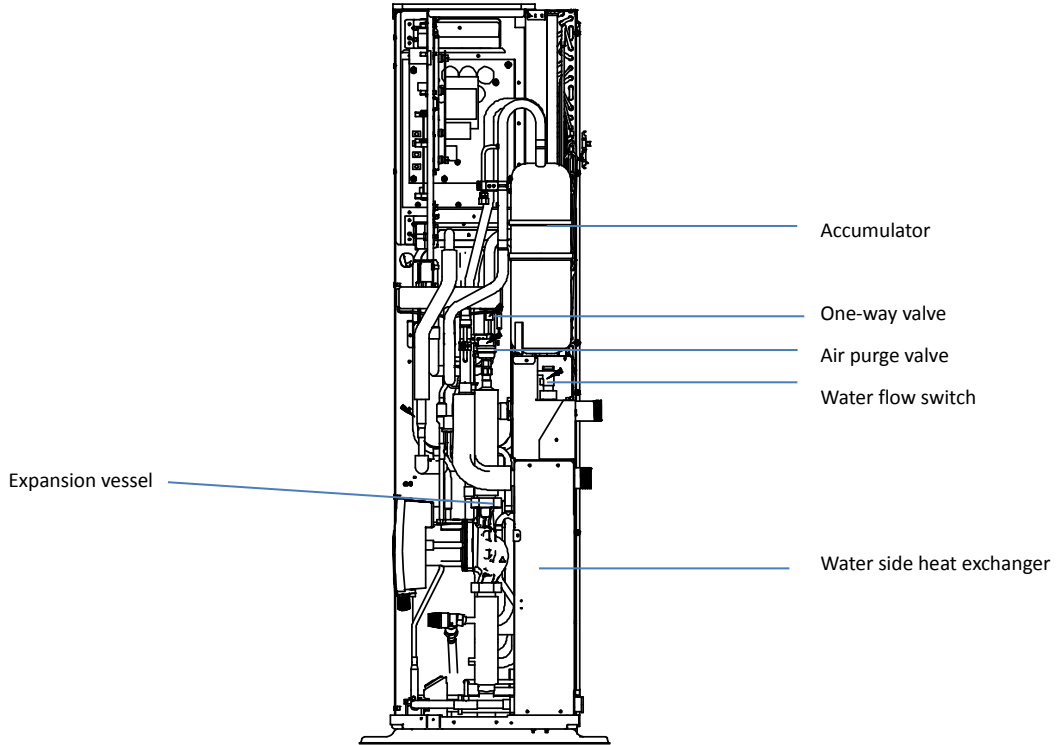
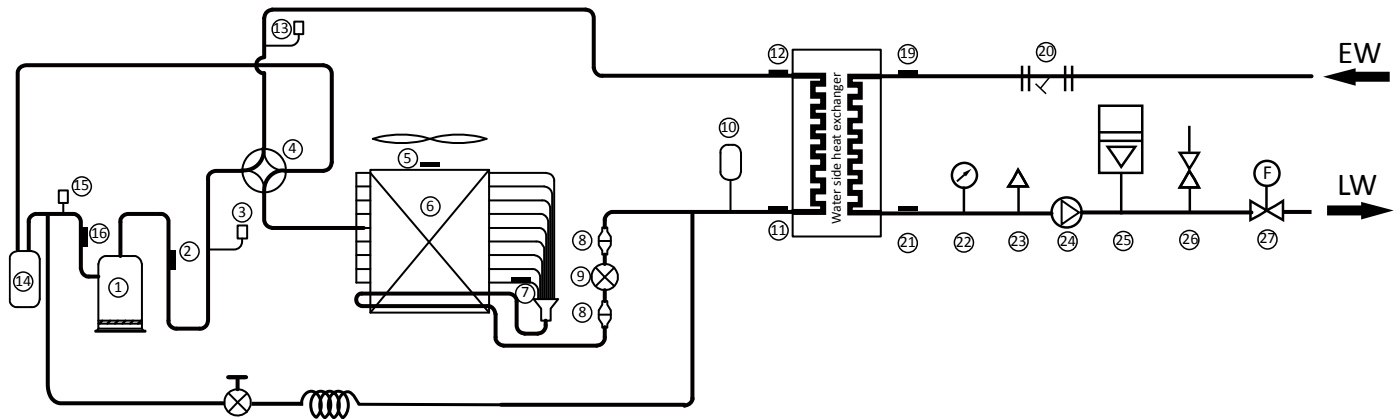

Figure 2-1.2: HOP18(22,26,30)WMONO3 side view



## 2 Piping Diagrams

Figure 2-2.1: HOP18(22,26,30)WMONO3 piping diagram



Legend			
1	Compressor	15	Low pressure switch
2	Discharge temperature sensor	16	Suction temperature sensor
3	High Pressure Switch	17	Single-way electromagnetic valve
4	4-Way Valve	18	Capillary
5	Outdoor temperature sensor	19	Water Inlet temp. sensor
6	Air side heat exchanger	20	Y-shape filter (Accessories)
7	Air side heat exchanger refrigerant outlet temperature sensor(cooling)	21	Water outlet temp. sensor
8	Filter	22	Manometer
9	Electronic expansion valve	23	Safety valve
10	Accumulator	24	Circulating pump
11	Refrigerant temperature sensor (liquid line)	25	Expansion vessel
12	Refrigerant temperature sensor (gas line)	26	Air purge valve
13	Pressure sensor	27	Flow switch
14	Gas-liquid separator		

## OPTIMUS PRO Mono

### Key components:

1. **Accumulator:**  
Stores liquid refrigerant and oil to protect compressor from liquid hammering.
2. **Electronic expansion valve (EXV):**  
Controls refrigerant flow and reduces refrigerant pressure.
3. **Four-way valve:**  
Controls refrigerant flow direction. Closed in cooling mode and open in heating mode. When closed, the air side heat exchanger functions as a condenser and water side heat exchanger functions as an evaporator; when open, the air side heat exchanger functions as an evaporator and water side heat exchanger function as a condenser.
4. **High and low pressure switches:**  
Regulate refrigerant system pressure. When refrigerant system pressure rises above the upper limit or falls below the lower limit, the high or low pressure switches turn off, stopping the compressor.
5. **Air purge valve:**  
Automatically removes air from the water circuit.
6. **Safety valve:**  
Prevents excessive water pressure by opening at 43.5 psi (3 bar) and discharging water from the water circuit.
7. **Expansion vessel:**  
Balances water system pressure. (Expansion vessel volume: 8L in 18/22/26/30kW units)
8. **Water flow switch:**  
Detects water flow rate to protect compressor and water pump in the event of insufficient water flow.
9. **Manometer:**  
Provides water circuit pressure readout.
10. **Water pump:**  
Circulates water in the water circuit.

### 3 Refrigerant Flow Diagrams

#### Heating and domestic hot water operation

Figure 2-3.1: Refrigerant flow during heating or domestic hot water operation

- High temperature, high pressure gas
- High temperature, high pressure liquid
- Low temperature, low pressure

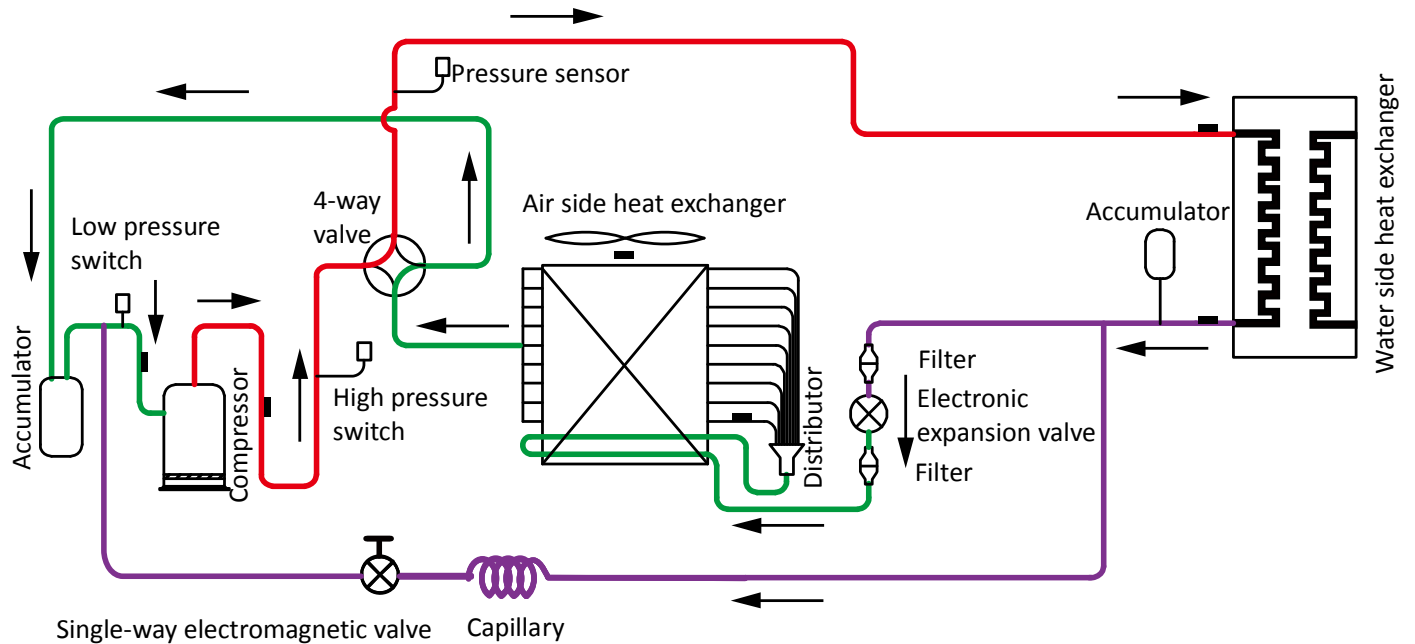

#### Cooling and defrosting operation

Figure 2-3.2: Refrigerant flow during cooling and defrosting operations

- High temperature, high pressure gas
- High temperature, high pressure liquid
- Low temperature, low pressure

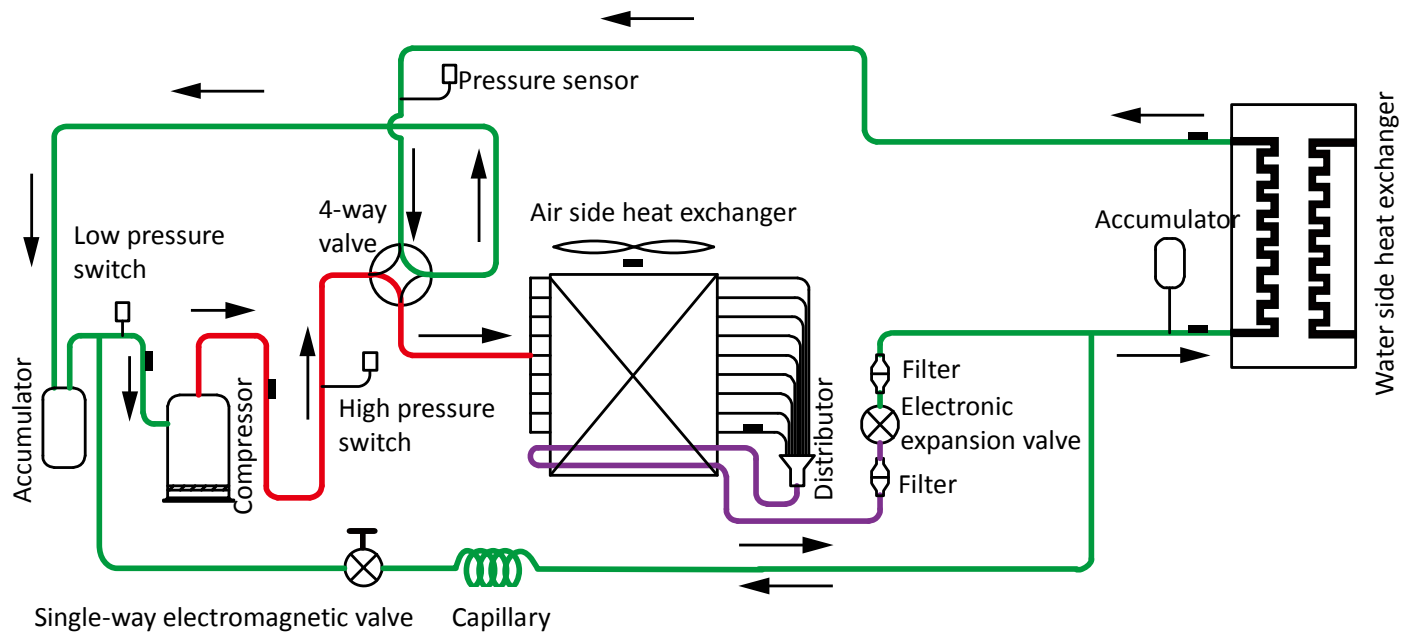



# Part 3

# Control

<b>1 Stop Operation .....</b>	<b>12</b>
<b>2 Standby Control .....</b>	<b>12</b>
<b>3 Startup Control .....</b>	<b>13</b>
<b>4 Normal Operation Control .....</b>	<b>14</b>
<b>5 Protection Control .....</b>	<b>16</b>
<b>6 Special Control.....</b>	<b>19</b>
<b>7 Roles of Temperature Sensors in Control Functions.....</b>	<b>22</b>



## 1 Stop Operation

The stop operation occurs for one of the following reasons:

1. Abnormal shutdown: in order to protect the compressors, if an abnormal state occurs the system makes a 'stop with thermo off' operation and an error code is displayed on the outdoor unit PCB and on the user interface.
2. The system stops when the set temperature has been reached.

## 2 Standby Control

### 2.1 Crankcase Heater Control

The crankcase heater is used to prevent refrigerant from mixing with compressor oil when the compressors are stopped. The crankcase heater is controlled according to outdoor ambient temperature and the compressor on/off state. When the outdoor ambient temperature is above 8°C or the compressor is running, the crankcase heater is off; when the outdoor ambient temperature is at or below 8°C and either the compressor has been stopped for more than 3 hours or the unit has just been powered-on (either manually or when the power has returned following a power outage), the crankcase heater turns on.

### 2.2 Water Pump Control

When the outdoor unit is in standby, the internal and external circulator pumps run continuously.

## 3 Startup Control

### 3.1 Compressor Startup Delay Control

In initial startup control and in restart control (except in oil return operation and defrosting operation), compressor startup is delayed such that a minimum of the set re-start delay time has elapsed since the compressor stopped, in order to prevent frequent compressor on/off and to equalize the pressure within the refrigerant system. The compressor re-start delays for cooling and heating modes are set on the user interface. Refer to the OPTIMUS PRO Mono Engineering Data Book Part 3, 7.5 "COOL MODE SETTING Menu" and Part 3, 7.6 "HEAT MODE SETTING Menu".

### 3.2 Compressor Startup Program

In initial startup control and in re-start control, compressor startup is controlled according to outdoor ambient temperature. There are two startup programs which both have 60 second stage for compressor to startup. Once the 60 second stage is complete, the program proceeds to the subsequent stages in a step-by-step fashion and exits when the target rotation speed has been reached.

### 3.3 Startup Control for Heating and Domestic Hot Water Operation

Table 3-3.1: Component control during startup in heating and domestic hot water modes

Component	Wiring diagram label	18/22/26/30kW	Control functions and states
Inverter compressor	COMP	•	Compressor startup program selected according to ambient temperature and discharge temperature
DC fan motor	FAN_UP / FAN_DOWN	•	Fan runs at higher speed
Electronic expansion valve	EEV1	•	304 steps
Four-way valve	ST	•	On

### 3.4 Startup Control for Cooling Operation

Table 3-3.2: Component control during startup in cooling mode

Component	Wiring diagram label	18/22/26/30kW	Control functions and states
Inverter compressor	COMP	•	Compressor startup program selected according to ambient temperature and discharge temperature
DC fan motor	FAN_UP / FAN_DOWN	•	Fan runs at higher speed
Electronic expansion valve	EEV1	•	304 steps
Four-way valve	ST	•	Off

## 4 Normal Operation Control

### 4.1 Component Control during Normal Operation

Table 3-4.1: Component control during heating and domestic hot water operations

Component	Wiring diagram label	18/22/26/30kW	Control functions and states
Inverter compressor	COMP	•	Controlled according to load requirement from hydronic system
DC fan motor	FAN_UP / FAN_DOWN	•	Controlled according to outdoor heat exchanger pipe temperature, ambient temperature and compressor speed
Electronic expansion valve	EEV1	•	Controlled according to discharge temperature, discharge superheat, suction superheat and compressor speed
Four-way valve	ST	•	On

Table 3-4.2: Component control during cooling operation

Component	Wiring diagram label	18/22/26/30kW	Control functions and states
Inverter compressor	COMP	•	Controlled according to load requirement from hydronic system
DC fan motor	FAN_UP / FAN_DOWN	•	Controlled according to outdoor heat exchanger pipe temperature, ambient temperature and compressor speed
Electronic expansion valve	EEV1	•	Controlled according to discharge temperature, discharge superheat, suction superheat and compressor speed
Four-way valve	ST	•	Off

### 4.2 Compressor Output Control

The compressor rotation speed is controlled according to the load requirement. Before compressor startup, the OPTIMUS PRO Mono outdoor unit determines the compressor target speed according to outdoor ambient temperature and discharge temperature and then runs the appropriate compressor startup program. Refer to Part 3, 3.2 “Compressor Startup Program”. Once the startup program is complete, the compressor runs at the target rotation speed.

During operation the compressor speed is controlled according to the setting and actual water temperature, the refrigerant system pressure, refrigerant temperature and ambient temperature.

### 4.3 Compressor Speed Control

The running speed of six-pole compressors (used on all models) in rotations per second (rps) is one third of the frequency (in Hz) of the electrical input to the compressor motor. The frequency of the electrical input to the compressor motors can be altered at a rate of 1Hz per second.

**4.4 Four-way Valve Control**

The four-way valve is used to change the direction of refrigerant flow through the water side heat exchanger in order to switch between cooling and heating/DHW operations. Refer to Figures 2-3.1 and 2-3.2 in Part 2, 3 “Refrigerant Flow Diagrams”.

During heating and DHW operations, the four-way valve is on; during cooling and defrosting operations, the four-way valve is off.

**4.5 Electronic Expansion Valve Control**

The position of the electronic expansion valve (EXV) is controlled in steps from 0 (fully closed) to 480 (fully open).

- When the outdoor unit is power on:
  - The EXV first closes fully, then moves to the standby position (304 steps). After compressor runs for 60-second, EXV is controlled according to ambient temperature. After a further 180s, EXV is controlled according to different modes.
- When the outdoor unit is in standby:
  - The EXV is at position 304 (steps).
- When the outdoor unit stops:
  - The EXV is fully closed firstly, then moves to the standby position (304 steps).

**4.6 Outdoor Fan Control**

The speeds of the outdoor unit fans are adjusted in steps, as shown below.

*Table 3-4.3: Fan speed index*

Fan speed index	Fan speed (rpm)	
	Upper fan	Lower fan
W1	200	180
W2	280	260
W3	340	320
W4	400	380
W5	460	440
W6	520	500
W7	580	560
W8	640	620
W9	700	680
W10	760	740
W11	820	800
W12	880	860
W13	900	900

# OPTIMUS PRO Mono

## 4.7 Spray liquid cooling control

If the discharge temperature exceeds  $105^{\circ}\text{C}$ , the solenoid valve opens. While the spray liquid cooling control is in progress, the discharge temperature is judged every 20s and the frequency of compressor drops 2Hz until the minimum frequency which differs from every model. When the discharge temperature is below  $95^{\circ}\text{C}$ , the compressor runs at the current frequency and solenoid valve closes.

If the discharge temperature exceeds  $108^{\circ}\text{C}$ , the solenoid valve opens. While the spray liquid cooling control is in progress, the discharge temperature is judged every 20s and the frequency of compressor drops 4Hz until the minimum frequency which differs from every model. When the discharge temperature is below  $95^{\circ}\text{C}$ , the compressor runs at the current frequency and solenoid valve closes.

## 5 Protection Control

### 5.1 High Pressure Protection Control

This control protects the refrigerant system from abnormally high pressure and protects the compressor from transient spikes in pressure.

Figure 3-5.1: High pressure protection control

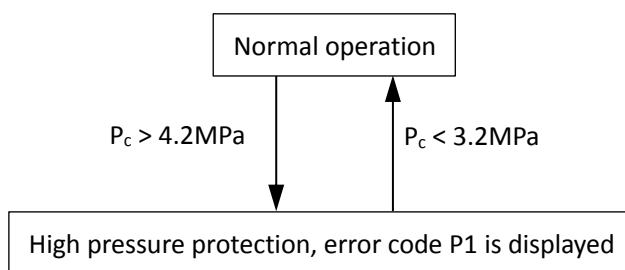

Notes:

1.  $P_c$ : Discharge pressure

When the discharge pressure rises above 4.2MPa the system displays P1 protection and the unit stops running. When the discharge pressure drops below 3.2MPa, the compressor enters re-start control.

### 5.2 Low Pressure Protection Control

This control protects the refrigerant system from abnormally low pressure and protects the compressor from transient drops in pressure.

Figure 3-5.2: Low pressure protection control

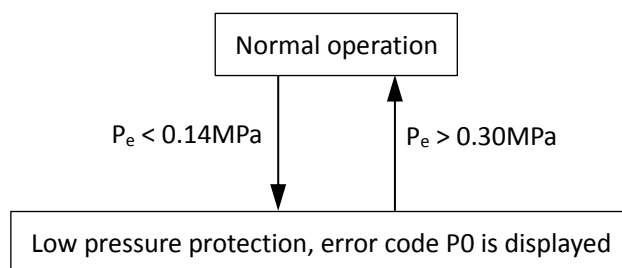

Notes:

1.  $P_e$ : Suction pressure

When the suction pressure drops below 0.14MPa the system displays P0 protection and the unit stops running. When the suction pressure rises above 0.3MPa, the compressor enters re-start control.

### 5.3 Discharge Temperature Protection Control

This control protects the compressor from abnormally high temperatures and transient spikes in temperature.

Figure 3-5.3: High discharge temperature protection control

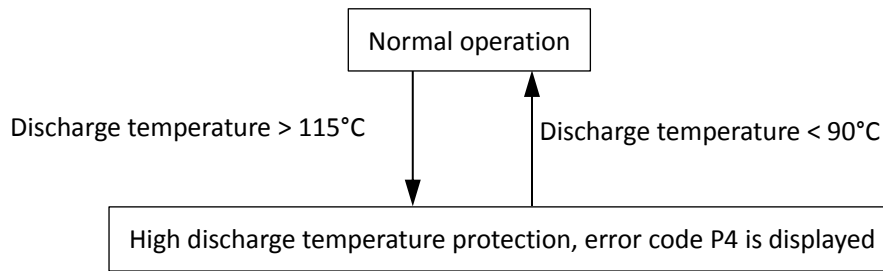

When the discharge temperature rises above 115°C the system displays P4 protection and the unit stops running. When the discharge temperature drops below 90°C, the compressor enters re-start control.

Figure 3-5.4: Low discharge temperature protection control

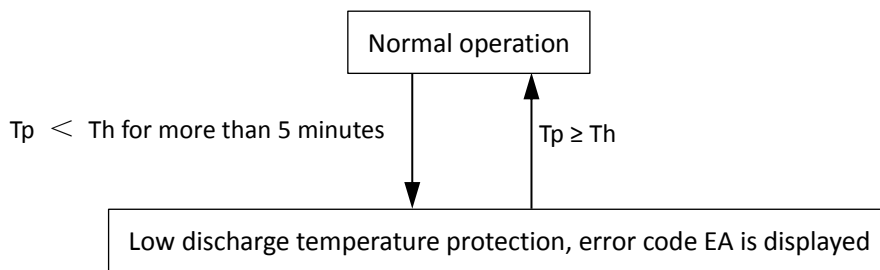

When the discharge temperature is lower than suction temperature for more than 5 minutes, the system displays EA protection and the unit stops running. When the discharge temperature is higher than suction temperature, the compressor enters re-start control.

### 5.4 Compressor Current Protection Control

This control protects the compressor from abnormally high currents.

Figure 3-5.5: Compressor current protection control

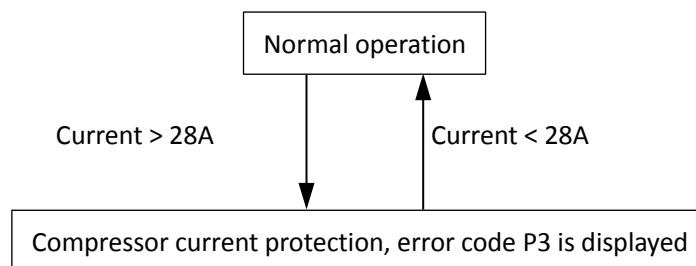

When the compressor current rises above  $\text{Current}_{\max}$  the system displays P3 protection and the unit stops running. When the compressor current drops below  $\text{Current}_{\max}$ , the compressor enters re-start control.

# OPTIMUS PRO Mono

## 5.5 Voltage Protection Control

This control protects the OPTIMUS PRO Mono from abnormally high or abnormally low voltages.

Figure 3-5.6: Compressor voltage protection control

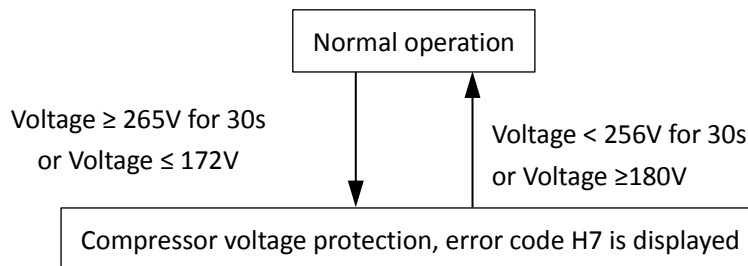

When the phase voltage of AC power supply is at or above 265V for more than 30 seconds, the system displays H7 protection and the unit stops running. When the phase voltage drops below 265V for more than 30 seconds, the refrigerant system restarts once the compressor re-start delay has elapsed. When the phase voltage is at or below 172V, the system displays H7 protection and the unit stops running. When the AC voltage rises to at or more than 180V, the refrigerant system restarts once the compressor re-start delay has elapsed.

## 5.6 DC Fan Motor Protection Control

This control protects the DC fan motors from strong winds and abnormal power supply. DC fan motor protection occurs when any one of the following three sets of conditions are met:

- Outdoor ambient temperature is at or above 4°C and actual fan speed differs from target fan speed by more than 200rpm for more than 3 minutes.
- Outdoor ambient temperature is below 4°C and actual fan speed differs from target fan speed by more than 300rpm for more than 3 minutes.
- Actual fan speed is less than 150rpm for more than 20 seconds.

When DC fan motor protection control occurs the system displays the H6 error code and the unit stops running. After 3 minutes, the unit restarts automatically. When H6 protection occurs 10 times in 120 minutes, the HH error is displayed. When an HH error occurs, a manual system restart is required before the system can resume operation.

## 5.7 Anti-freeze Protection Control

This control protects the water side heat exchanger from ice formation.

In cooling mode, if inlet water temperature or leaving water temperature or auxiliary heat source leaving water temperature is below 4°C, heat pump stops and water pump keeps running for 30min. If water temperature is still below 4°C, heat pump turns to heating mode.

In heating/DHW standby mode, if ambient temperature is below 3°C and inlet water temperature or leaving water temperature or auxiliary heat source leaving water temperature is below 5°C, heat pump stops and water pump keeps running for 30min. If ambient temperature is still below 3°C and water temperature is still below 5°C, heat pump turns to heating mode.

In heating/DHW standby mode, if leaving water temperature is below 2°C, heat pump stops and water pump keeps running for 30min. If water temperature is still below 2°C heat pump turns to heating mode to protect from anti-freezing.

When water side heat exchanger anti-freeze protection occurs the system displays error code Pb and the unit stops running.

### 5.8 Module Temperature Protection Control

This control protects the module from abnormally high temperatures.

Figure 3-5.7: Module Temperature Protection Control

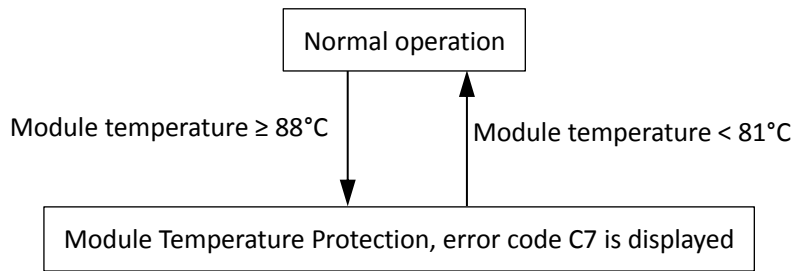

When the module temperature rises at or above 88°C, the system displays C7 protection and the unit stops running. When the module temperature is below 81°C, error disappears and unit runs normally.

## 6 Special Control

### 6.1 Oil Return Operation

In order to prevent the compressor from running out of oil, the oil return operation is conducted to recover oil that has flowed out of the compressor and into the refrigerant piping.

Timing of oil return operation:

- When the compressor cumulative operating time with running rotation speed less than 42rps reaches 6 hours.

The oil return operation ceases when any one of the following three conditions occurs:

- Oil return operation duration reaches 5 minutes.
- Compressor stops.
- Mode change command is received.

Table 3-6.1: Outdoor unit component control during oil return operation in cooling mode

Component	Wiring diagram label	18/22/26/30kW	Control functions and states
Inverter compressor	COMP	●	Runs at oil return operation rotation speed
DC fan motor	FAN_UP / FAN_DOWN	●	Controlled according to outdoor heat exchanger pipe temperature, ambient temperature, discharge temperature and compressor speed
Electronic expansion valve	EEV1	●	304 (steps)
Four-way valve	ST	●	Off

Table 3-6.2: Outdoor unit component control during oil return operation in heating and DHW modes

Component	Wiring diagram label	18/22/26/30kW	Control functions and states
Inverter compressor	COMP	●	Runs at oil return operation rotation speed
DC fan motor	FAN_UP / FAN_DOWN	●	Controlled according to outdoor heat exchanger pipe temperature, ambient temperature, discharge temperature and compressor speed
Electronic expansion valve	EEV1	●	304 (steps)
Four-way valve	ST	●	On



# OPTIMUS PRO Mono

## 6.2 Defrosting Operation

In order to recover heating capacity, the defrosting operation is conducted when the outdoor unit air side heat exchanger is performing as a condenser. The defrosting operation is controlled according to outdoor ambient temperature, air side heat exchanger refrigerant outlet temperature and the compressor running time.

The defrosting operation ceases when any one of the following three conditions occurs:

- Defrosting operation duration reaches 10 minutes.
- The air side heat exchanger refrigerant outlet temperature is above 8°C for more than 10 seconds.
- The air side heat exchanger refrigerant outlet temperature is above 12°C.
- Water side heat exchanger water outlet temperature sensor is less than 10°C for 5s and air side heat exchanger refrigerant outlet temperature is above 5°C.
- Water side heat exchanger water outlet temperature sensor is less than 7°C for 5s.

Table 3-6.3: Component control during defrosting operation

Component	Wiring diagram label	18/22/26/30kW	Control functions and states
Inverter compressor	COMP	●	Runs at defrosting operation rotation speed
DC fan motor	FAN_UP / FAN_DOWN	●	Off
Electronic expansion valve	EEV1	●	Fully open
Four-way valve	ST	●	Off

## 6.3 Fast DHW Operation

Fast DHW operation is used to quickly meet a requirement for domestic hot water when DHW priority has been set on the user interface. Refer to the OPTIMUS PRO Mono Engineering Data Book Part 3, 7.4 "DHW MODE SETTING Menu".

Domestic hot water demand priority can be ended by changing the switch on controller from "on" to "off".

Table 3-6.4: Component control during fast DHW operation

Component	Wiring diagram label	18/22/26/30kW	Control functions and states
Inverter compressor	COMP	●	Controlled according to load requirement
DC fan motor	FAN_UP / FAN_DOWN	●	Controlled according to outdoor heat exchanger pipe temperature, ambient temperature and compressor speed.
Electronic expansion valve	EEV1	●	Controlled according to pressure, temperature and compressor speed.
Four-way valve	ST	●	On
Tank electric heater(Optional)	TBH	●	On

## 6.4 Two zones control<sup>1</sup>

Two zones control function is used to control temperature of each zone separately, thus different type radiator will operate at its optimal temperature and water pump cycle time will be reduced to save energy.

- Cooling mode

In two zones control for cooling mode, when the setting temperature of a certain zones is reached, the zone and water pump of this zone will turn off.

- Heating mode

In two zones control for heating mode, the on/off control of zone and water pump is same with cooling mode, but in addition, the mixing valve (3-way valve SV3) control function will be activated to adjust the water temperature of the low temperature zone by control the opening time and closing time of the valve. The mixing valve will only turn on when two

zones control for heating is activated. On other conditions, the mixing valve will keep off. When the valve initially turns on, the opening time and closing time is same and then the time is controlled according to the difference between water pipe temperature and setting water temperature of the controlling zone.

- Hydronic adapter PCB (Optional)

With the help of hydronic adapter PCB, totally 8 thermostats can be used at the same time for maximum 8 rooms to control heat pump.

*Note:*

1. *OPTIMUS PRO units just have the controlling function, while the mixing valve, water pump of each zone need to be field supplied and connect to OPTIMUS PRO unit.*

## 6.5 Smart grid control

Unit adjusts the operation according to different electrical signals to realize energy saving.

Free electric energy signal: DHW mode turn on, the setting temperature will be changed to 70°C automatically, and the TBH operate as below:  $T5 < 69^{\circ}\text{C}$ , the TBH is on;  $T5 \geq 70^{\circ}\text{C}$ , the TBH is off. The unit operates in cooling/heating mode as the normal logic.

Common electric energy signal: unit operates according to users' need.

Expensive electric energy signal: only available for cooling or heating mode and user can set the maximum operating time.

## 6.6 Balance tank temperature control

Balance tank temperature sensor is used to control on/off of heat pump.

Once the heat pump stops, internal pump stops to save energy and then balance tank provides hot water for space heating. In addition, balance tank temperature control can meet both space heating and domestic hot water needs at the same time. Balance tank can store energy to provide hot water whilst heat pump runs heat mode/cooling, which can reduce the host selection and the initial investment.

## 6.7 USB data transfer

- Convenient program upgrade

No need to carry any other heavy equipments but only USB can realize program upgrade of indoor unit and outdoor unit.

- Parameter setting transmission between wired controllers

Installer can quickly copy the setting from one controller to another via USB, which save the time of on-site installation.

## 6.8 Dry contract M1M2 control

M1M2 can be set in the wired controller for heat pump on/off control, TBH control, AHS control.

- For heat pump on/off control

When dry contract closes for 1s, heat pump stops. When dry contract opens for 5s, heat pump on/off according to wired controller or room thermostat setting.

- For TBH control

TBH is only controlled by M1M2. If dry contract closes,  $T5 < 65^{\circ}\text{C}$  then TBH opens until water tank temperature reaches 70°C.

- For AHS control

In heating mode, AHS on/off is only controlled by M1M2. In DHW mode, M1M2 control does not affect AHS on/off.

## 7 Role of Temperature Sensors in Control Functions

Figure 3-7.1: Location of the temperature sensors on 18~30kW unit systems

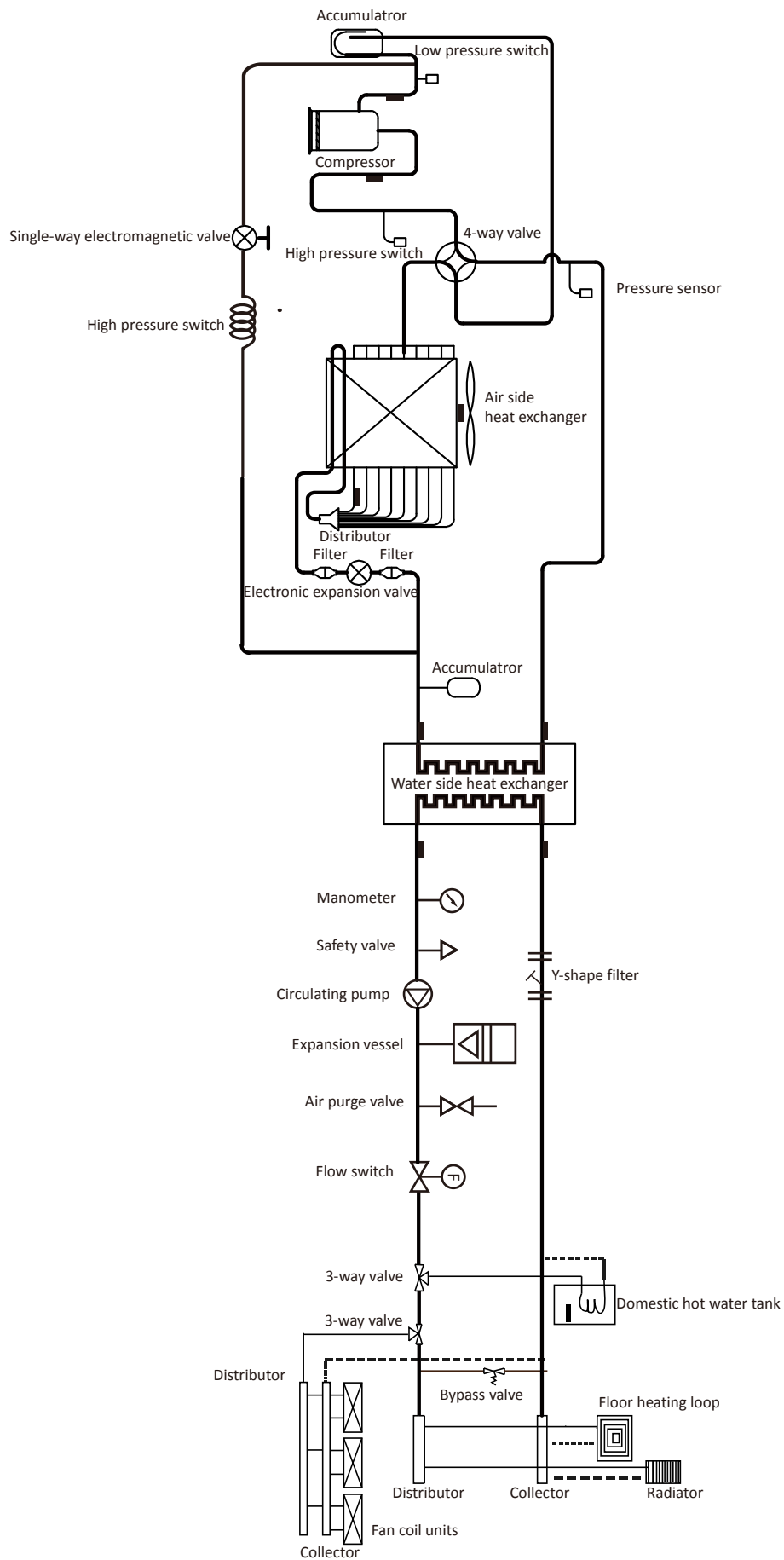

Notes: The names and functions of the temperature sensors labelled 1 to 12 in this figure are detailed in Table 3-7.1.

Table 3-7.1: Names and functions of the temperature sensors

Number	Sensor name <sup>1</sup>	Sensor code	Mode	Control functions
1	Discharge pipe temperature sensor	Tp	Heating	<ul style="list-style-type: none"> <li>▪ Electronic expansion valve control<sup>2</sup></li> <li>▪ Discharge superheat control</li> </ul>
			Cooling	<ul style="list-style-type: none"> <li>▪ Electronic expansion valve control<sup>2</sup></li> <li>▪ Outdoor fan control<sup>3</sup></li> <li>▪ Discharge superheat control</li> </ul>
2	Outdoor ambient temperature sensor	T4	Heating	<ul style="list-style-type: none"> <li>▪ Compressor startup control<sup>4</sup></li> <li>▪ Compressor output control<sup>5</sup></li> <li>▪ Electronic expansion valve control<sup>2</sup></li> <li>▪ Defrosting operation control<sup>7</sup></li> <li>▪ Low pressure protection control<sup>7</sup></li> <li>▪ Crankcase heater control<sup>9</sup></li> </ul>
			Cooling	<ul style="list-style-type: none"> <li>▪ Compressor startup control<sup>4</sup></li> <li>▪ Compressor output control<sup>5</sup></li> <li>▪ Electronic expansion valve control<sup>2</sup></li> <li>▪ Outdoor fan control<sup>3</sup></li> <li>▪ Crankcase heater control<sup>9</sup></li> </ul>
3	Air side heat exchanger refrigerant outlet temperature sensor	T3	Heating	<ul style="list-style-type: none"> <li>▪ Electronic expansion valve control<sup>2</sup></li> <li>▪ Defrosting operation control<sup>7</sup></li> <li>▪ Outdoor fan control<sup>3</sup></li> </ul>
			Cooling	<ul style="list-style-type: none"> <li>▪ Compressor output control<sup>5</sup></li> <li>▪ Outdoor fan control<sup>3</sup></li> </ul>
4	Water side heat exchanger refrigerant inlet (liquid pipe) temperature sensor	T2	Heating	<ul style="list-style-type: none"> <li>▪ Compressor output control<sup>5</sup></li> </ul>
			DHW	
5	Water side heat exchanger refrigerant outlet (gas pipe) temperature sensor	T2B	Heating	<ul style="list-style-type: none"> <li>▪ Freeze prevention control<sup>10</sup></li> </ul>
6	Suction pipe temperature sensor	Th	Heating	<ul style="list-style-type: none"> <li>▪ Electronic expansion valve control<sup>2</sup></li> </ul>
			Cooling	
7	Water side heat exchanger water inlet temperature sensor	Tw_in	Heating	<ul style="list-style-type: none"> <li>▪ Freeze prevention control<sup>10</sup></li> </ul>
			Cooling	
8	Water side heat exchanger water outlet temperature sensor	Tw_out	Heating	<ul style="list-style-type: none"> <li>▪ Compressor output<sup>5</sup> and on/off control<sup>6</sup></li> <li>▪ Freeze prevention control<sup>10</sup></li> </ul>
			Cooling	
			DHW	
9	Final water outlet temperature sensor	T1	Heating	<ul style="list-style-type: none"> <li>▪ Compressor output control<sup>5</sup></li> <li>▪ Backup electric heater control</li> <li>▪ DHW priority control<sup>11</sup></li> <li>▪ Auto mode control</li> </ul>
			Cooling	<ul style="list-style-type: none"> <li>▪ Compressor output<sup>5</sup> and on/off control<sup>6</sup></li> <li>▪ Auto mode control</li> </ul>
			DHW	<ul style="list-style-type: none"> <li>▪ Compressor output control<sup>5</sup></li> <li>▪ Backup electric heater control</li> <li>▪ DHW priority control<sup>11</sup></li> </ul>
10	Domestic hot water tank temperature sensor	T5	DHW	<ul style="list-style-type: none"> <li>▪ Disinfection operation control</li> <li>▪ DHW tank immersion heater control</li> <li>▪ Backup electric heater control</li> <li>▪ Auxiliary heat source control</li> <li>▪ Solar energy kit control</li> <li>▪ Compressor output control<sup>5</sup></li> <li>▪ DHW priority control<sup>11</sup></li> </ul>
11	Room temperature sensor (built in wired controller)	Ta	Heating	<ul style="list-style-type: none"> <li>▪ Auto mode control</li> <li>▪ Climate related curve</li> <li>▪ Compressor output control<sup>5</sup></li> </ul>
			Cooling	

Notes:

- |   |   |
|---|---|
| <ol style="list-style-type: none"> <li>1. Sensor names in this service manual referring to refrigerant flow is named according refrigerant flow during cooling operation refer to Part 2, 3 "Refrigerant Flow Diagrams".</li> <li>2. Refer to Part 3, 4.5 "Electronic Expansion Valve Control".</li> <li>3. Refer to Part 3, 4.6 "Outdoor Fan Control".</li> <li>4. Refer to Part 3, 2 "Compressor Startup Program".</li> <li>5. Refer to Part 3, 4.2 "Compressor Output Control".</li> </ol> | <ol style="list-style-type: none"> <li>6. Refer to Part 3, 1 "Stop Operation".</li> <li>7. Refer to Part 3, 6.2 "Defrosting Operation".</li> <li>8. Refer to Part 3, 5.2 "Low Pressure Protection Control".</li> <li>9. Refer to Part 3, 2.1 "Crankcase Heater Control".</li> <li>10. Refer to Part 3, 5.7 "Water Side Heat Exchanger Anti-freeze Protection Control".</li> <li>11. Refer to Part 3, 6.3 "Fast DHW Operation".</li> </ol> |
|---|---|



# Part 4

# Diagnosis and Troubleshooting

1 Outdoor Unit Electric Control Box Layout .....	26
2 Outdoor Unit PCBs .....	27
3 Error Code Table .....	34
4 Troubleshooting .....	36
5 Appendix to Part 4 .....	89

# OPTIMUS PRO Mono

## 1 Outdoor Unit Electric Control Box Layout

Figure 4-1.1: Electric control box front view

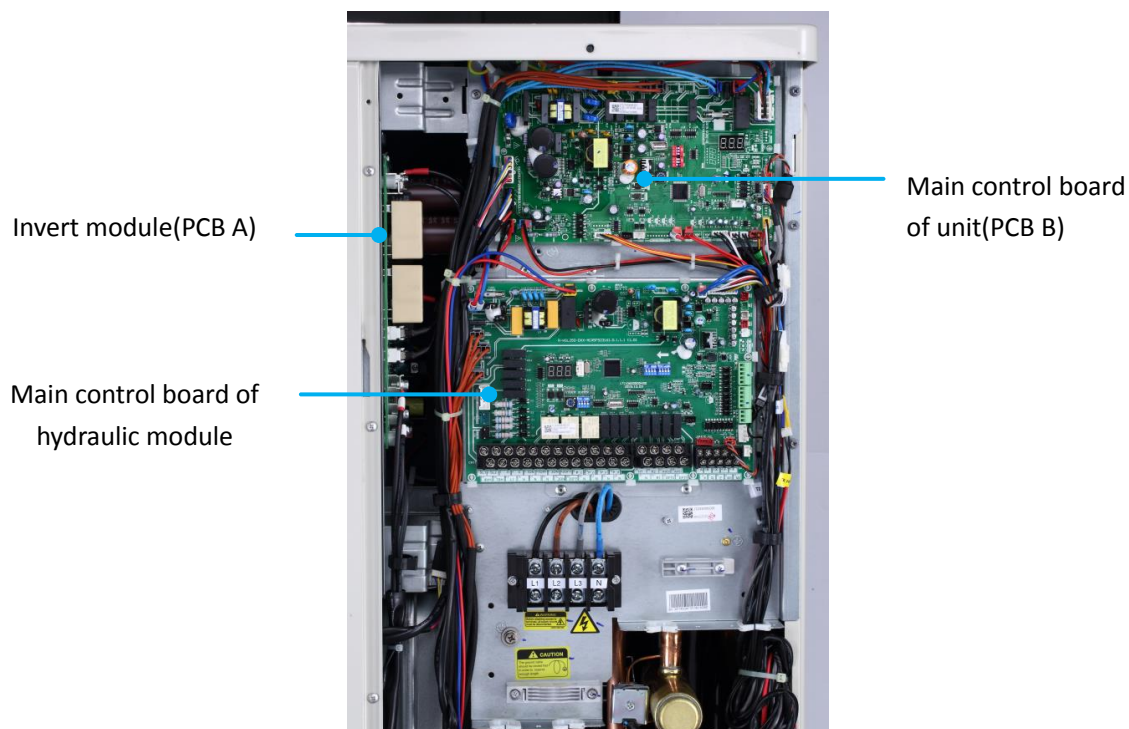
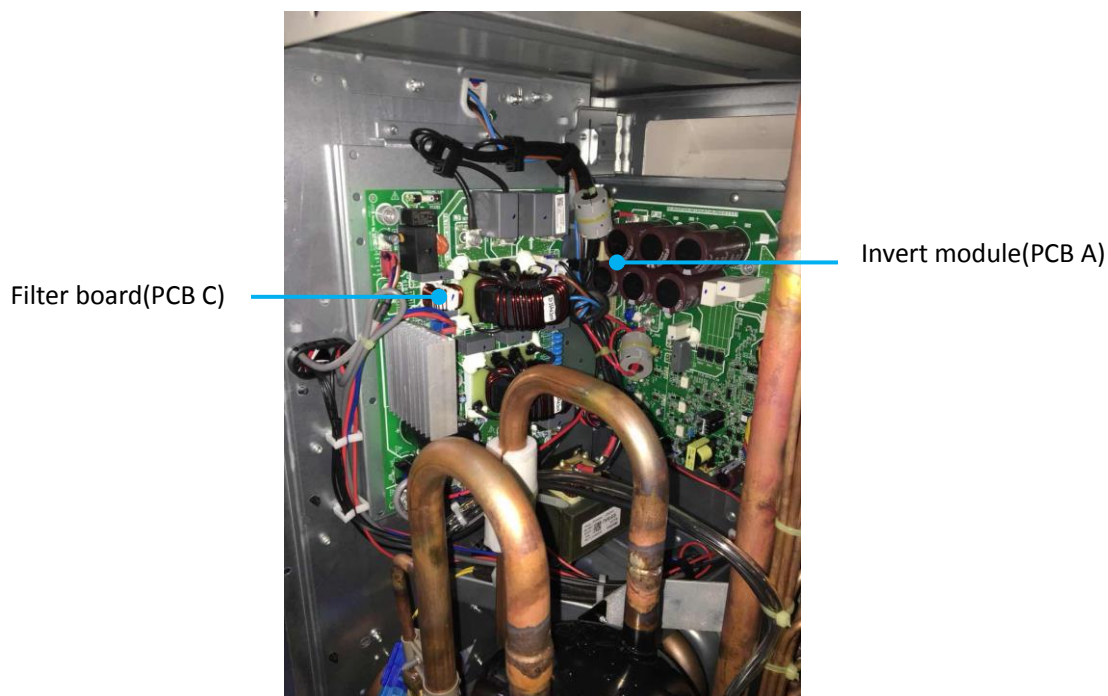

Figure 4-1.2: Electric control box side view









# OPTIMUS PRO Mono

Table 4-2.1: HOP18(22,26,30)WMONO3 hydronic system main PCB

Label in Figure 4-2.1	Code	Content
1	CN21	Port for power supply
2	S3	Rotary dip switch
3	DIS1	Digital display
4	CN5	Port for ground
5	CN28	Port for variable speed pump power input
6	CN25	Port for IC programming
7	S1,S2,S4	Dip switch
8	CN4	Port for USB programming
9	CN8	Port for Flow switch
10	CN6	Port for temp. sensors (T2,T2B,TW_out,TW_in, T1,)
11	CN24	Port for temp. sensor(Tbt1, The balanced water tank of up temp. sensor)
12	CN16	Port for temp. sensor(Tbt2, The balanced water tank of up temp. sensor)
13	CN13	Port for temp. sensor(T5, domestic hot water tank temp. sensor)
14	CN15	Port for temp. sensor(Tw2, The outlet water for zone 2 temp. sensor)
15	CN18	Port for temp. sensor(Tsolar, Solar panel temp. sensor)
16	CN17	Port for variable speed pump communication
17	CN31	Control port for room thermostat (heating mode)(HT)/Control port for room thermostat (cooling mode)(CL)/Power port for room thermostat(COM)
18	CN35	Port for smart grid (grid signal, photovoltaic signal)
19	CN36	Port for remote switch, temperature board
20	CN19	Communicate port between indoor unit and outdoor unit
21	CN14	Port for communication with the wired controller
22	CN30	Communicate port between indoor unit and outdoor unit, port for communication with the wired controller, internal machine parallel
23	CN7	Port for antifreeze E-heating tape(external), additional heat source, compressor run/defrost run
24	CN11	Control port for tank booster heater, internal backup heater 1, input port for solar energy, Port for room thermostat, SV1(3-way valve), SV2(3-way valve), SV3(3-way valve), zone 2 pump, outside circulation pump, solar energy pump, DHW pipe pump,
25	CN2	Feedback port for external temp. switch(shorted in default)
26	CN1	Feedback port for temperature switch(shorted in default)
27	CN22	Control port for backup heater1/booster heater/Reserved
28	CN41	Port for anti-freeze electric heating tape
29	CN42	Port for anti-freeze electric heating tape
30	CN29	Port for anti-freeze electric heating tape
31	IC39	EEPROM

Figure 4-2.2: HOP18(22,26,30)WMONO3 outdoor unit main PCB for refrigerant system

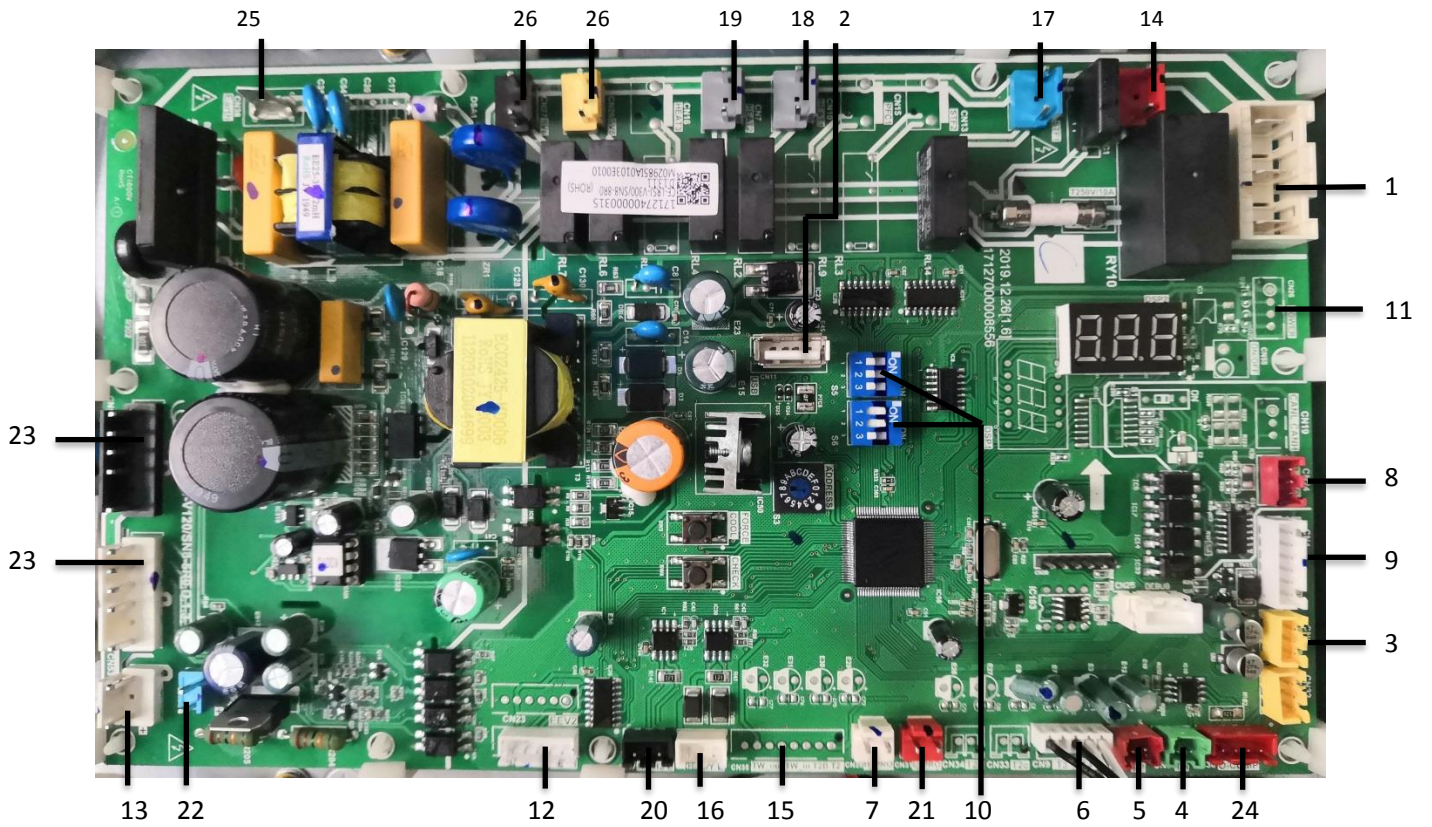

# OPTIMUS PRO Mono

Table 4-2.2: HOP18(22,26,30)WMONO3 outdoor unit main PCB for refrigerant system

Label in Figure 4-2.2	Code	Content
1	CN41	Power supply port for PCB B
2	CN11	Port for IC programming
3	CN6	Port for pressure sensor
4	CN5	Port for suction temp. sensor
5	CN8	Port for discharge temp. sensor
6	CN9	Port for outdoor ambient temp. sensor and condenser temp. sensor
7	CN29	Port for low pressure switch and quick check
8	CN24	Port for communication with hydro-box control board
9	CN4	Port for communication with PCB C
10	S5, S6	DIP switch
11	CN26	Port for communication with Power Meter
12	CN22	Port for electrical expansion valve
13	CN53	Port for fan 310VDC power supply
14	CN21	Power supply port for hydro-box control board
15	CN35	Port for other temp. sensor
16	CN28	Port for communication XYE
17	CN18	Port for 4-way valve
18	CN10	Port for electric heating tape1
19	CN7	Port for electric heating tape2
20	CN37	Port for communication D1D2E
21	CN31	Port for high pressure switch and quick check
22	CN30	Port for fan 15VDC power supply
23	CN107/109	Port for fan
24	CN36	Port for communication with PCB A
25	CN38	Port for GND
26	CN20/27	Port for SV

Figure 4-2.3: HOP18(22,26,30)WMONO3 outdoor unit inverter module

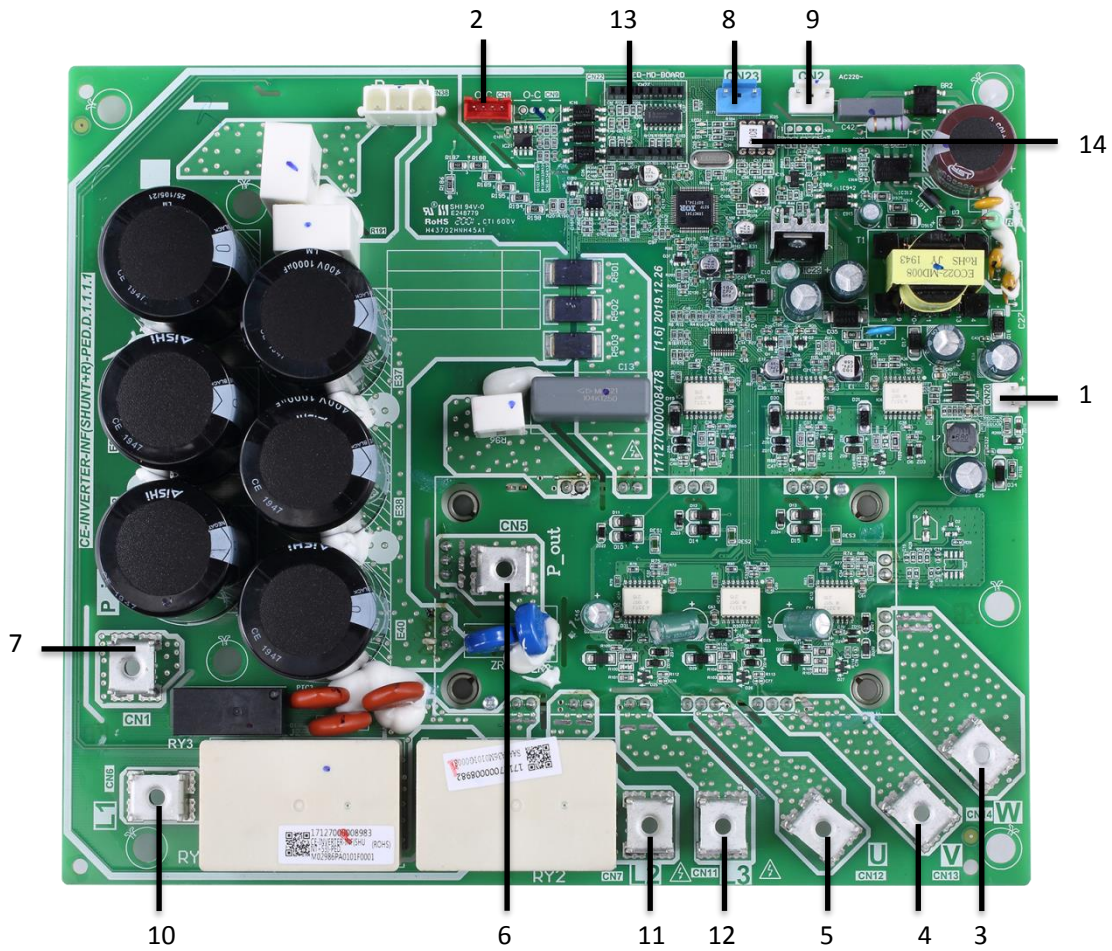

Table 4-2.3: HOP18(22,26,30)WMONO3 outdoor unit inverter module

Label in Figure 4-2.3	Code	Content
1	CN20	Output port for +15V
2	CN8	Port for communication with PCB B
3	W	Compressor connection port W
4	U	Compressor connection port U
5	V	Compressor connection port V
6	-	Input port P_out for IPM module
7	-	Input port P_in for IPM module
8	CN23	Input port for high pressure switch
9	CN2	Power for switching power supply
10	L1'	Power filtering L1
11	L2'	Power filtering L2
12	L3'	Power filtering L3
13	-	PED board
14	IC25	EEPROM



# OPTIMUS PRO Mono

Figure 4-2.4: HOP18(22,26,30)WMONO3 outdoor unit filter board

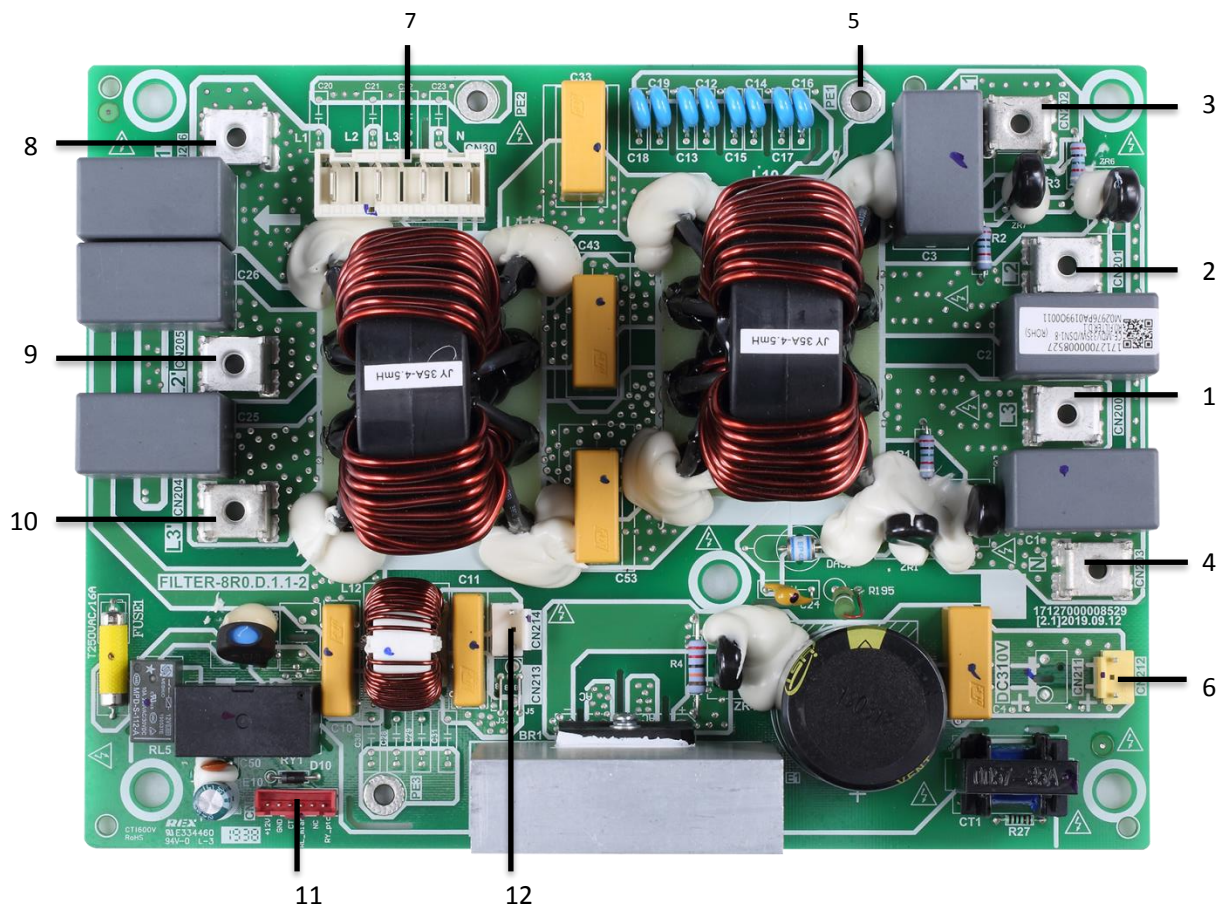



Table 4-2.4: HOP18(22,26,30)WMONO3 outdoor unit filter board

Label in Figure 4-2.4	Code	Content
1	L3	Power supply L3
2	L2	Power supply L2
3	L1	Power supply L1
4	N	Power supply N
5	PE1	Ground wire
6	CN212	Power supply port for DC fan
7	CN30	Power supply port for main control board
8	L1'	Power filtering L1
9	L2'	Power filtering L2
10	L3'	Power filtering L3
11	CN8	Port for communication with PCB B
12	CN214	Power supply for PCB A switching power supply

### 2.3 Digital Display Output

Table 4-2.5: Digital display output in different operating states

Outdoor unit state	Parameters displayed on hydronic system DSP1	Parameters displayed on refrigerant system DSP1	
On standby	0	0	
Normal operation	Leaving water temperature (°C)	Running speed of the compressor in rotations per second	
Error or protection	Error or protection code	Error or protection code	

### 2.4 Modbus Function

Figure 4-2.6: Connection

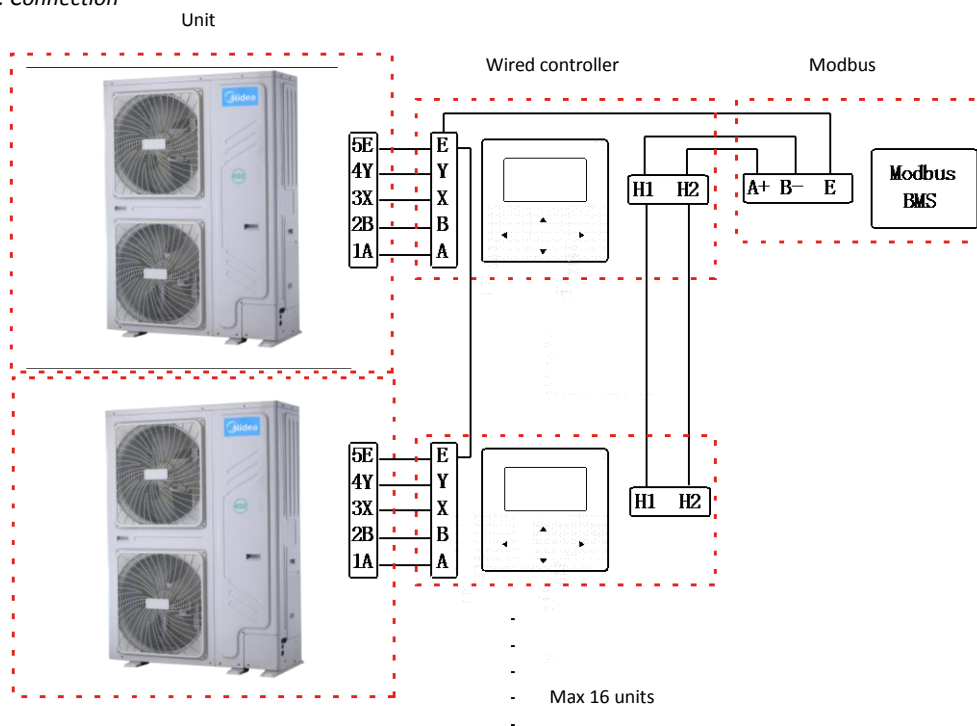
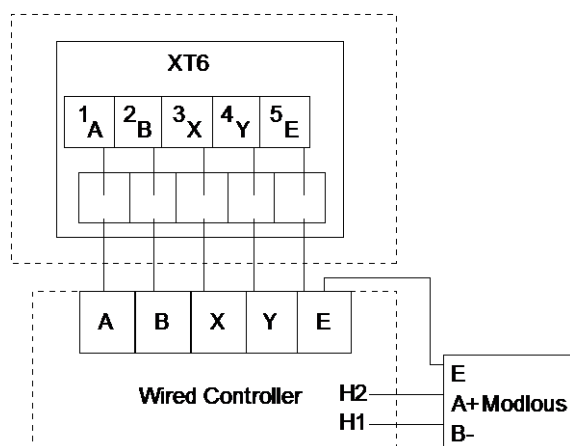

Figure 4-2.7: Wiring



## 3 Error Code Table

Table 4-3.1: Error code table

Error code	Content
bH	PED PCB fault
C7	High temp. protection of inverter module
E0	Water flow fault (E8 displayed 3 times)
E1	Phase loss or neutral wire and live wire are connected reversely (only for three phase unit)
E2	Communication fault between controller and main control board of hydraulic module
E3	Final outlet water temp. sensor (T1) fault.
E4	Water tank temp. sensor (T5) fault.
E5	The condenser outlet refrigerant temperature sensor (T3) fault
E6	The ambient temperature sensor (T4) fault.
E7	The balance tank up temp. sensor (Tbt1 ) fault.
E8	Water flow fault.
E9	Compressor suction temp. sensor (Th) fault.
EA	Compressor discharge temp. sensor (Tp) fault
Eb	Solar panel temp.sensor (Tsolar) fault.
Ec	The balance tank low temp.sensor(Tbt2) fault
Ed	The plate exchanger water inlet temp. sensor (Tw_in) fault.
EE.	The main control board of hydraulic module EEPROM fault.
F1	DC bus low voltage protection
H0	Communication fault between main control board of hydraulic module and main control board PCB B(Main control board of unit)
H1	Communication fault between inverter module PCB A(Inverter module) and main control board PCB B(Main control board of unit)
H2	The plate exchanger refrigerant outlet (liquid pipe) temp. sensor (T2) fault.
H3	The plate exchanger refrigerant outlet (gas pipe) temp. sensor (T2B) fault.
H4	Three times P6 protection
H5	Room temp.sensor (Ta) fault
H6	DC fan motor fault.
H7	Main circuit voltage protection fault
H8	Pressure sensor fault.
H9	Zone 2 water flow temp. sensor (Tw2) fault.
HA	The plate heat exchanger water outlet temperature sensor (Tw_out) fault.
Hb	Three times "PP" protection and Tw_out < 7C°
Hd	Communication fault between master unit and slave unit (in parallel)
HE	Communication fault between indoor unit and Ta / room thermostart transfer PCB.
HF	Inverter module board EE PROM fault
HH	H6 displayed 10 times in 120 minutes.
HP	Low pressure protection (Pe<0.6) occured 3 times in 1 hour in cooling mode
P0	Low pressure protection
P1	High pressure protection
P3	Compressor overcurrent protection

Table continued on next page ...

Table 4-3.1: Error code table (continued)

P4	Compressor discharge temp. too high protection
----	--

## OPTIMUS PRO Mono

P5	High Temperature difference protection between water inlet and water outlet of the plate heat exchanger.
P6	Inverter module protection
Pb	Anti-freeze mode protection
Pd	High temperature protection of refrigerant outlet temp. of condenser
PP	Water inlet temperature is higher than water outlet in heating mode
L0	DC compressor inverter module fault
L1	DC bus low voltage protection (from inverter module mostly when compressor running)
L2	DC bus high voltage protection from DC driver
L4	MCE fault
L5	Zero speed protection
L7	Phase sequence fault
L8	Compressor frequency variation greater than 15Hz within 1 second protection
L9	Actual compressor frequency differs from target frequency by more than 15Hz protection



## 4 Troubleshooting

### 4.1 Warning

#### Warning



- All electrical work must be carried out by competent and suitably qualified, certified and accredited professionals and in accordance with all applicable legislation (all national, local and other laws, standards, codes, rules, regulations and other legislation that apply in a given situation).
- Power-off the outdoor units before connecting or disconnecting any connections or wiring, otherwise electric shock (which can cause physical injury or death) may occur or damage to components may occur.

## 4.2 E0, E8 Troubleshooting

### 4.2.1 Digital display output

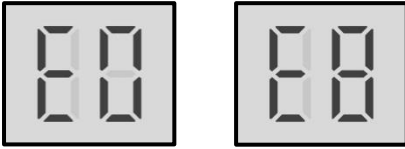

### 4.2.2 Description

- Water flow failure.
- E0 indicates E8 has displayed 3 times. When an E0 error occurs, a manual system restart is required before the system can resume operation.
- OPTIMUS PRO Mono stops running.
- Error code is displayed on hydronic system main PCB and user interface.

### 4.2.3 Possible causes

- The wire circuit is short connected or open.
- Water flow rate is too low.
- Water flow switch damaged.

## 4.2.4 Procedure

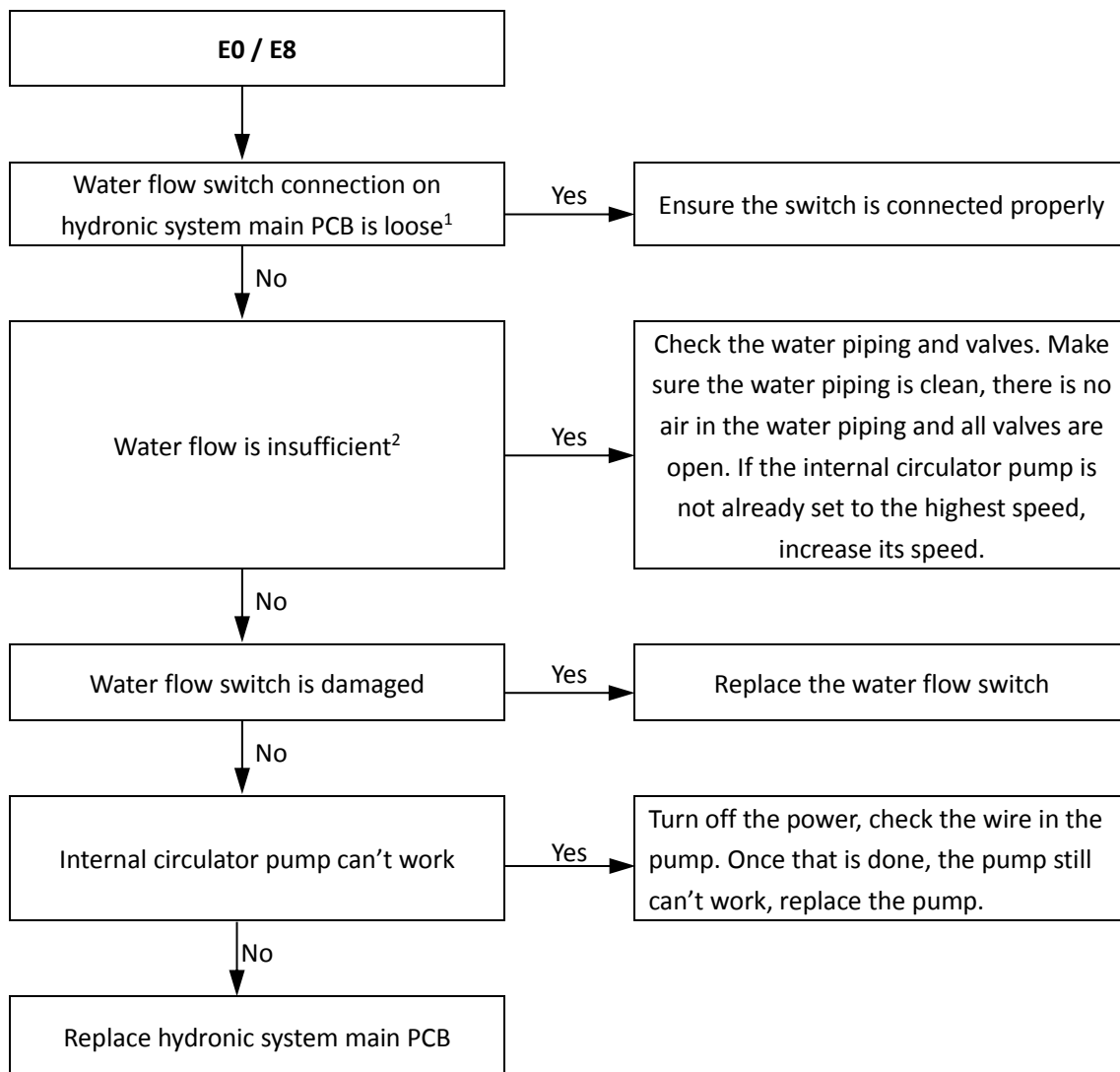

Notes:

1. Water flow switch connection is port CN8 on the main PCB for hydronic system (labeled 9 in Figure 4-2.1).
2. Check water pressure on the manometer. If the water pressure is not > 1 bar, water flow is insufficient. Refer to Figure 2-1.1.

## 4.3 E1 Troubleshooting

### 4.3.1 Digital display output



### 4.3.2 Description

- Phase sequence error.
- OPTIMUS PRO Mono stops running.
- Error code is displayed on outdoor unit main PCB and user interface.

### 4.3.3 Possible causes

- Power supply phases not connected in correct sequence.
- Power supply terminals loose.
- Power supply abnormal.
- Main PCB damaged.

## 4.3.4 Procedure

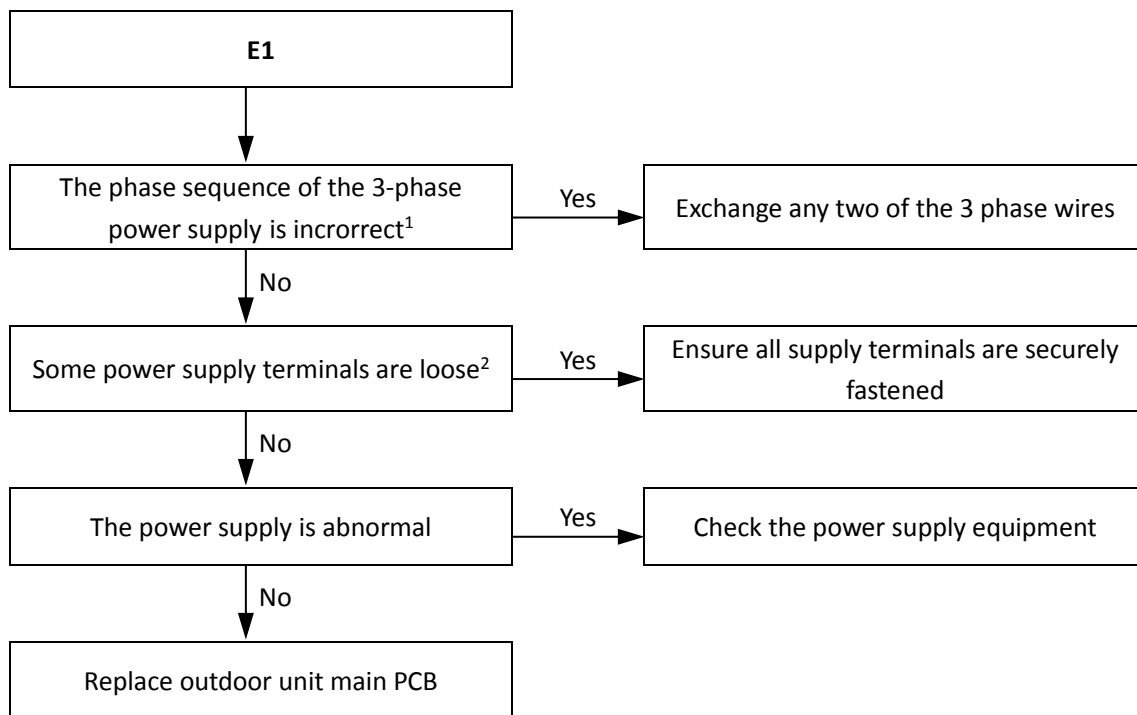

### Notes:

1. The A, B, C terminals of 3-phase power supply should match compressor phase sequence requirements. If the phase sequence is inverted, the compressor will operate inversely. If the wiring connection of each outdoor unit is in A, B, C phase sequence, and multiple units are connected, the current difference between C phase and A, B phases will be very large as the power supply load of each outdoor unit will be on C phase. This can easily lead to tripped circuits and terminal wiring burnout. Therefore if multiple units are to be used, the phase sequence should be staggered, so that the current is distributed among the three phases equally.
2. Loose power supply terminals can cause the compressors to operate abnormally and compressor current to be very large.

## 4.4 E2 Troubleshooting

### 4.4.1 Digital display output



### 4.4.2 Description

- Communication error between hydronic system and user interface.
- OPTIMUS PRO Mono stops running.
- Error code is displayed on hydronic system main PCB and user interface.

### 4.4.3 Possible causes

- Communication wires between hydronic system and user interface not connected properly.
- Communication wiring X Y E terminals misconnected.
- Loosened wiring within electric control box.
- Interference from high voltage wires or other sources of electromagnetic radiation.
- Damaged main PCB or electric control box communication terminals block.

# OPTIMUS PRO Mono

## 4.4.4 Procedure

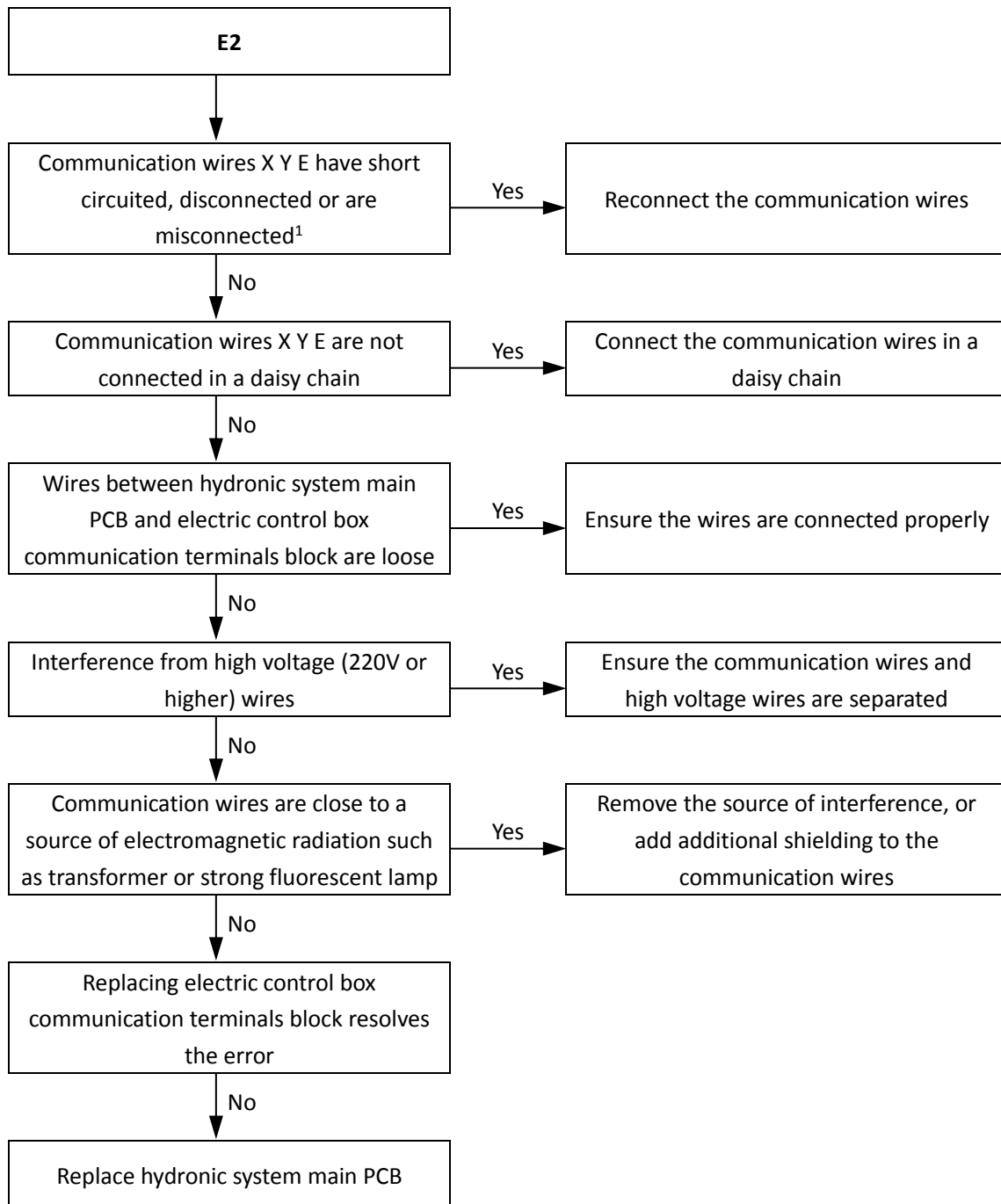

### Notes:

1. Measure the resistance among X, Y and E. The normal resistance between X and Y is 120Ω, between X and E is infinite, between Y and E is infinite. Communication wiring has polarity. Ensure that the X wire is connected to X terminals and the Y wire is connected to Y terminals.

## 4.5 E3, E4, H2, H3, Ed, HA, H5, H9, Eb, E7, Ec Troubleshooting

### 4.5.1 Digital display output

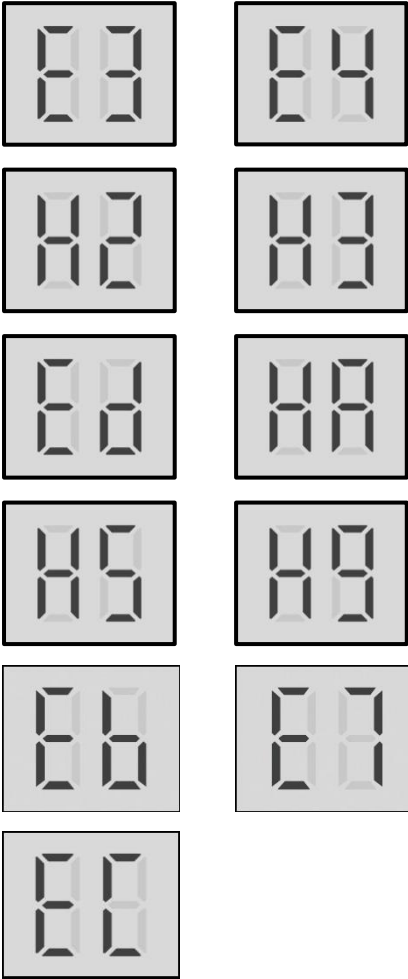

### 4.5.2 Description

- E3 indicates final outlet water temperature sensor error
- E4 indicates a domestic hot water tank temperature sensor error.
- H2 indicates a water side heat exchanger refrigerant outlet (liquid pipe)temperature sensor error.
- H3 indicates a water side heat exchanger refrigerant inlet (gas pipe)temperature sensor error.
- Ed indicates a water side heat exchanger water inlet temperature sensor error.
- HA indicates a water side heat exchanger water outlet temperature sensor error.
- H5 indicates a room temperature sensor error.
- H9 indicates a circuit 2 water outlet temperature sensor error.
- Eb indicates solar panel temperature sensor error
- E7 indicates balance tank upper temperature sensor error
- EC indicates balance tank nether temperature sensor error
- OPTIMUS PRO Mono stops running.
- Error code is displayed on hydronic system main PCB and user interface.

### 4.5.3 Possible causes

- Temperature sensor not connected properly or has malfunctioned.
- Damaged hydronic system main PCB.



## 4.5.4 Procedure

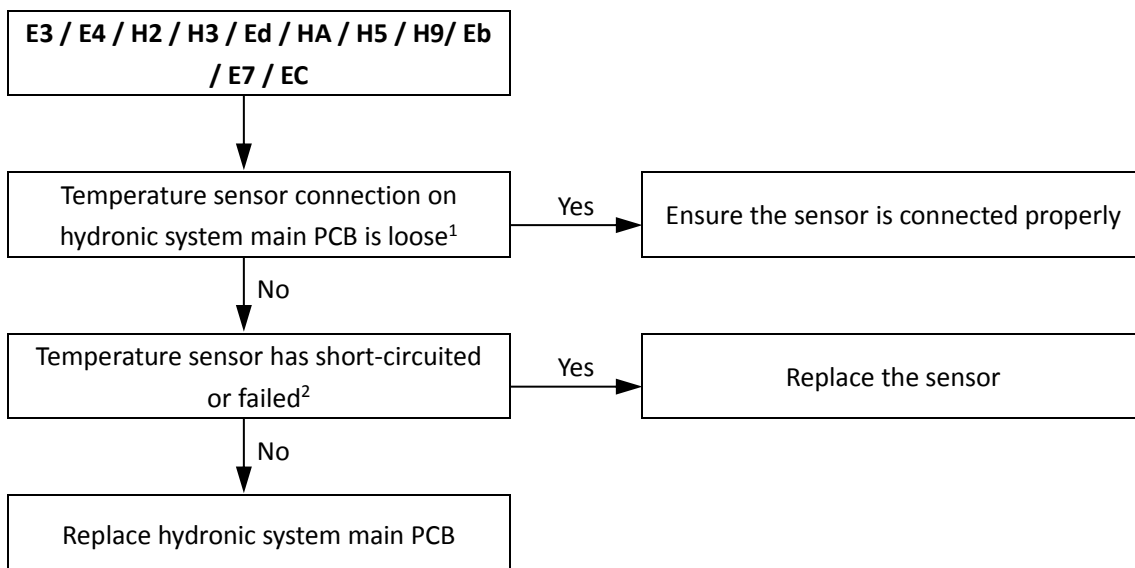

Notes:

- Final water outlet temperature sensor, water side heat exchanger refrigerant inlet (liquid pipe) temperature sensor, water side heat exchanger refrigerant outlet (gas pipe) temperature sensor, water side heat exchanger water inlet temperature sensor and water side heat exchanger water outlet temperature sensor connections are port CN6 on the hydronic system main PCB (labeled 10 in Figure 4-2.1). Domestic hot water tank temperature sensor connection is port CN13 on the hydronic system main PCB (labeled 13 in Figure 4-2.1). Circuit 2 water outlet temperature sensor connection is port CN15 on the hydronic system main PCB (labeled 14 in Figure 4-2.1). Room temperature sensor connection is port CN11 on the hydronic system main PCB (labeled 24 in Figure 4-2.1). Solar panel temperature sensor connection is port CN18 on the hydronic system main PCB (labeled 15 in Figure 4-2.1). Balance tank upper temperature sensor connection is port CN24 on the hydronic system main PCB (labeled 11 in Figure 4-2.1) Balance tank nether temperature sensor connection is port CN16 on the hydronic system main PCB (labeled 12 in Figure 4-2.1)
- Set a multi-meter to buzzer mode and test any two terminals of sensor. If the resistance is too low, the buzzer sounds, which means the sensor has short-circuited. If the resistance is not consistent with the sensor's resistance characteristics table, the sensor has failed. Refer to Table 4-5.1 or 4-5.3.

## 4.6 E5, E6, E9, EA Troubleshooting

### 4.6.1 Digital display output

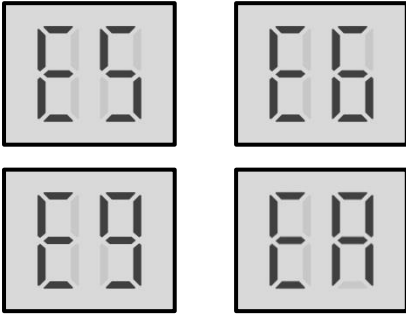

### 4.6.2 Description

- E5 indicates an air side heat exchanger refrigerant outlet temperature sensor error.
- E6 indicates an outdoor ambient temperature sensor error.
- E9 indicates a suction pipe temperature sensor error.
- EA indicates a discharge temperature sensor error.
- OPTIMUS PRO Mono stops running.
- Error code is displayed on outdoor unit main PCB and user interface.

### 4.6.3 Possible causes

- Temperature sensor not connected properly or has malfunctioned.
- Damaged outdoor unit main PCB.

# OPTIMUS PRO Mono

## 4.6.4 Procedure

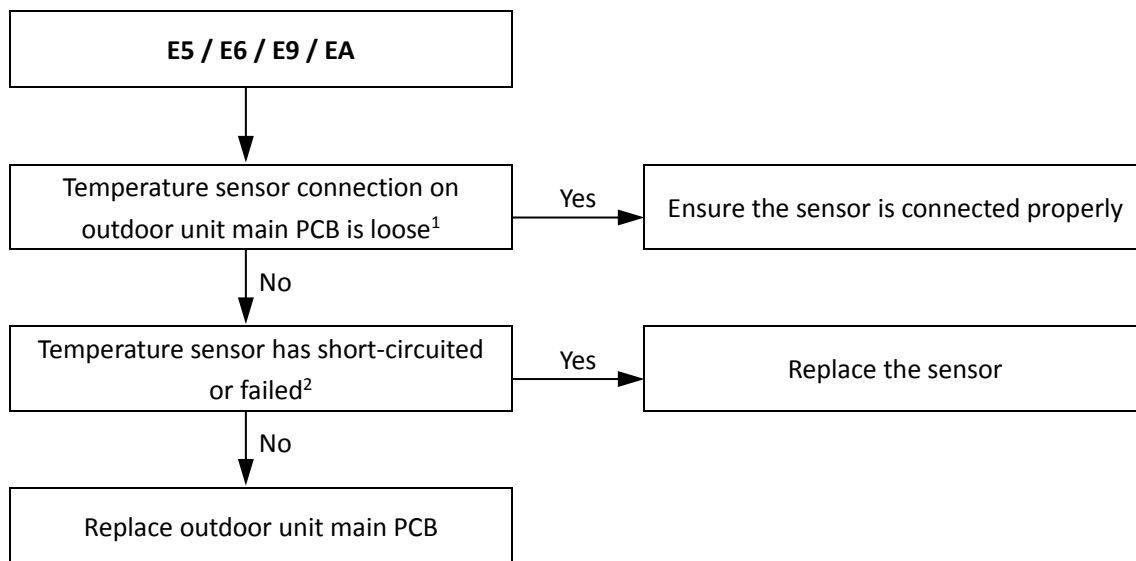

### Notes:

1. Air side heat exchanger refrigerant outlet temperature sensor and outdoor ambient temperature sensor connections are port CN9 on the outdoor unit refrigerant system main PCB (labeled 6 in Figure 4-2.2). Discharge pipe temperature sensor connection are port CN8 on the outdoor unit refrigerant system main PCB (labeled 5 in Figure 4-2.2). Suction pipe temperature sensor connection are port CN5 on the outdoor unit refrigerant system main PCB (labeled 4 in Figure 4-2.2).
2. Set a multi-meter to buzzer mode and test any two terminals of sensor. If the resistance is too low, the buzzer sounds, which means the sensor has short-circuited. If the resistance is not consistent with the sensor's resistance characteristics table, the sensor has failed. Refer to Table 4-5.1, and Table 4-5.2.

## 4.7 EE Troubleshooting

### 4.7.1 Digital display output



### 4.7.2 Description

- Hydronic system main PCB EEPROM error.
- OPTIMUS PRO Mono stops running.
- Error code is displayed on hydronic system main PCB and user interface.

### 4.7.3 Possible causes

- Hydronic system main PCB EEPROM is not connected properly.
- Hydronic system main PCB damaged.

### 4.7.4 Procedure

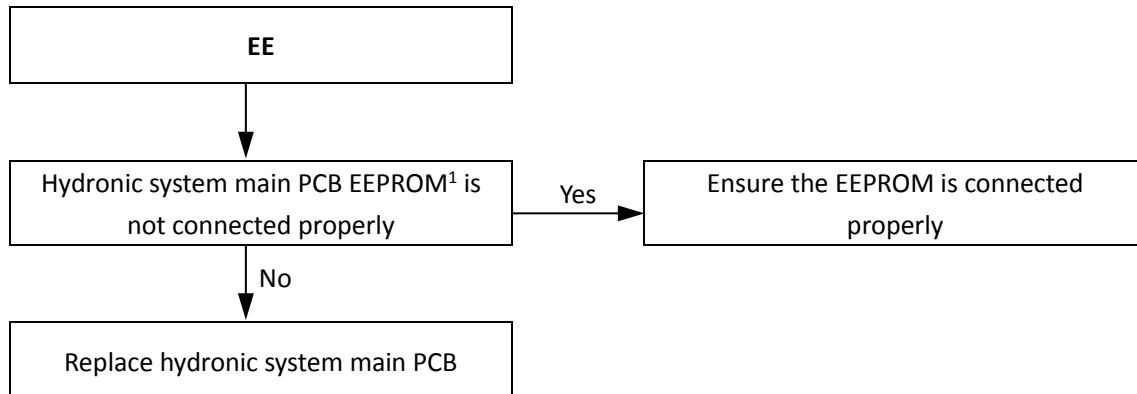

#### Notes:

1. Hydronic system main PCB EEPROM is designated IC39 on the main PCB for hydronic system (labeled 31 in Figure 4-2.1).

# OPTIMUS PRO Mono

## 4.8 F1 Troubleshooting

### 4.8.1 Digital display output



### 4.8.2 Description

- Low DC generatrix voltage.
- OPTIMUS PRO Mono stops running.
- Error code is displayed on hydronic system main PCB and user interface.

### 4.8.3 Possible causes

- The DC generatrix voltage is too low.

### 4.8.4 Procedure

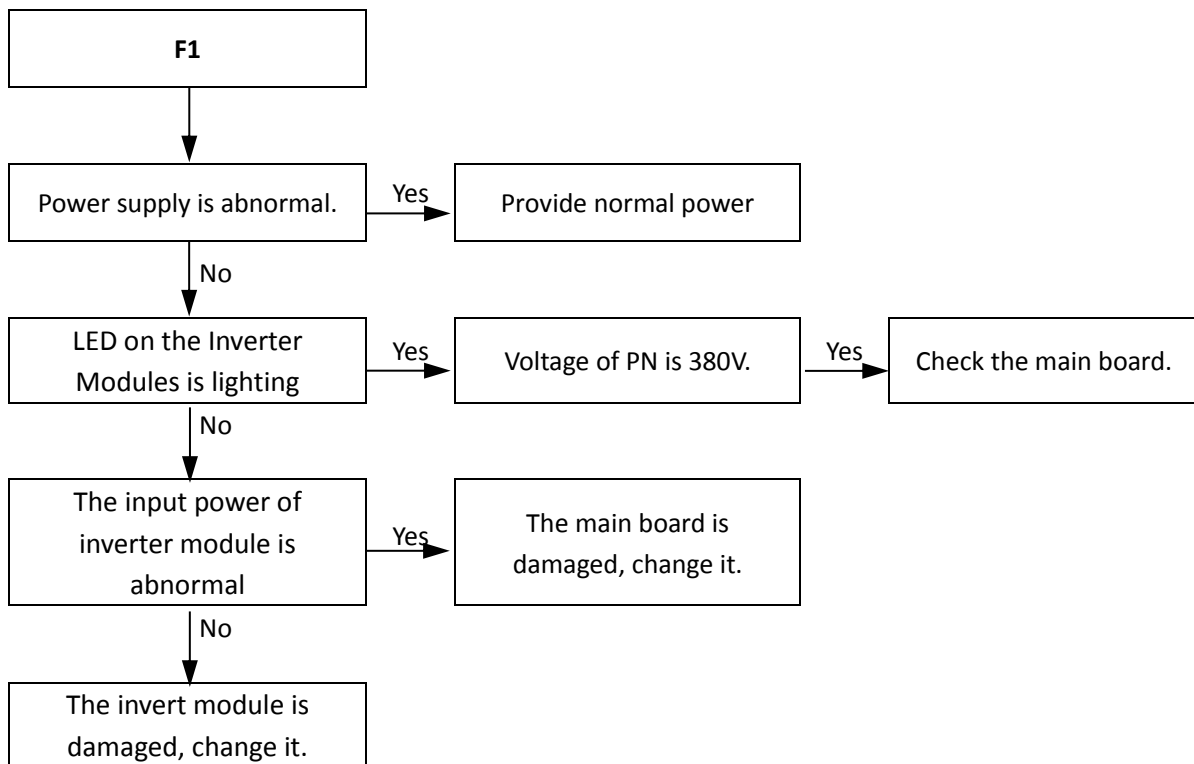

## 4.9 HF Troubleshooting

### 4.9.1 Digital display output



### 4.9.2 Description

- Outdoor unit inverter module EEPROM error.
- OPTIMUS PRO Mono stops running.
- Error code is displayed on outdoor unit main PCB and user interface.

### 4.9.3 Possible causes

- Outdoor unit invert module EEPROM is not connected properly.
- Outdoor unit invert module EEPROM damaged.

### 4.9.4 Procedure

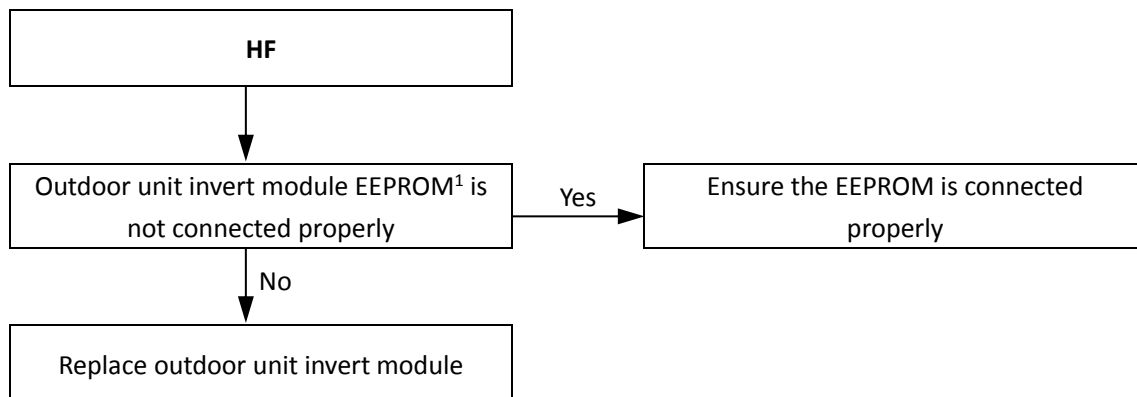

Notes:

1. Outdoor unit invert module EEPROM is designated IC25 on the outdoor unit invert module (labeled 14 in Figure 4-2.3)..

# OPTIMUS PRO Mono

## 4.10 H0 Troubleshooting

### 4.10.1 Digital display output



### 4.10.2 Description

- Communication error between outdoor unit and hydronic system.
- OPTIMUS PRO Mono stops running.
- Error code is displayed on hydronic system main PCB, outdoor unit main PCB and user interface.

### 4.10.3 Possible causes

- Power supply abnormal.
- Transformer malfunction.
- Interference from a source of electromagnetic radiation.
- Outdoor unit main PCB or hydronic system main PCB damaged.

## 4.10.4 Procedure

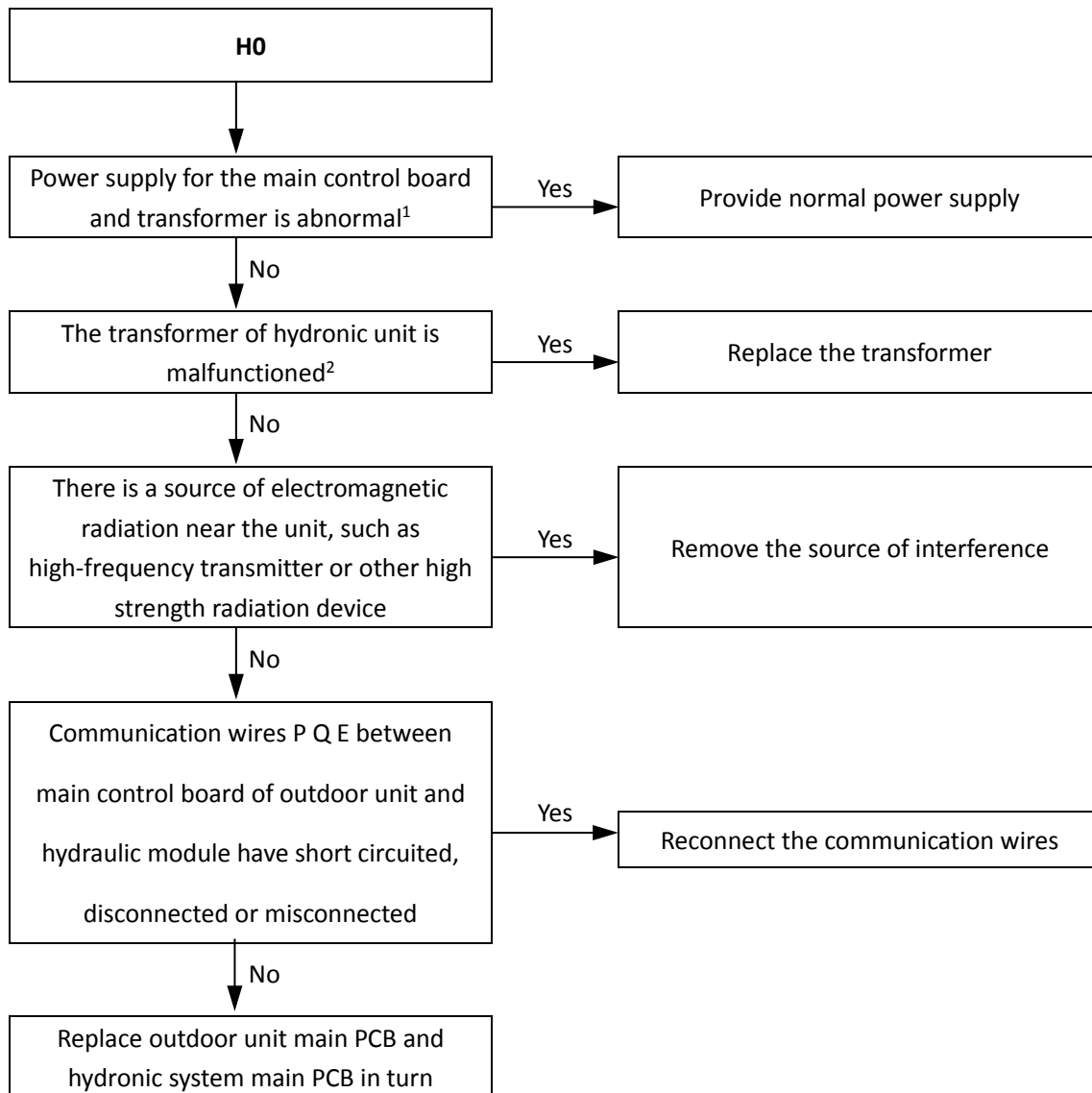

## Notes:

1. Measure the voltages of transformer input port and out port. The input voltage of transformer is 220V AC, output voltage of transformer is 13.5V AC. If any voltages is abnormal, the power supply for the main control board of hydraulic module and transformer will be abnormal.
2. Measure the voltages of transformer output port ports. If the voltages are not normal, the transformer has malfunctioned.



# OPTIMUS PRO Mono

## 4.11 H1 Troubleshooting

### 4.11.1 Digital display output



### 4.11.2 Description

- Communication error between outdoor unit main control board and inverter module.
- OPTIMUS PRO Mono stops running.
- Error code is displayed on outdoor unit main PCB and user interface.

### 4.11.3 Possible causes

- Power supply abnormal.
- Interference from a source of electromagnetic radiation.
- Outdoor unit main PCB or inverter driven module damaged.

### 4.11.4 Procedure

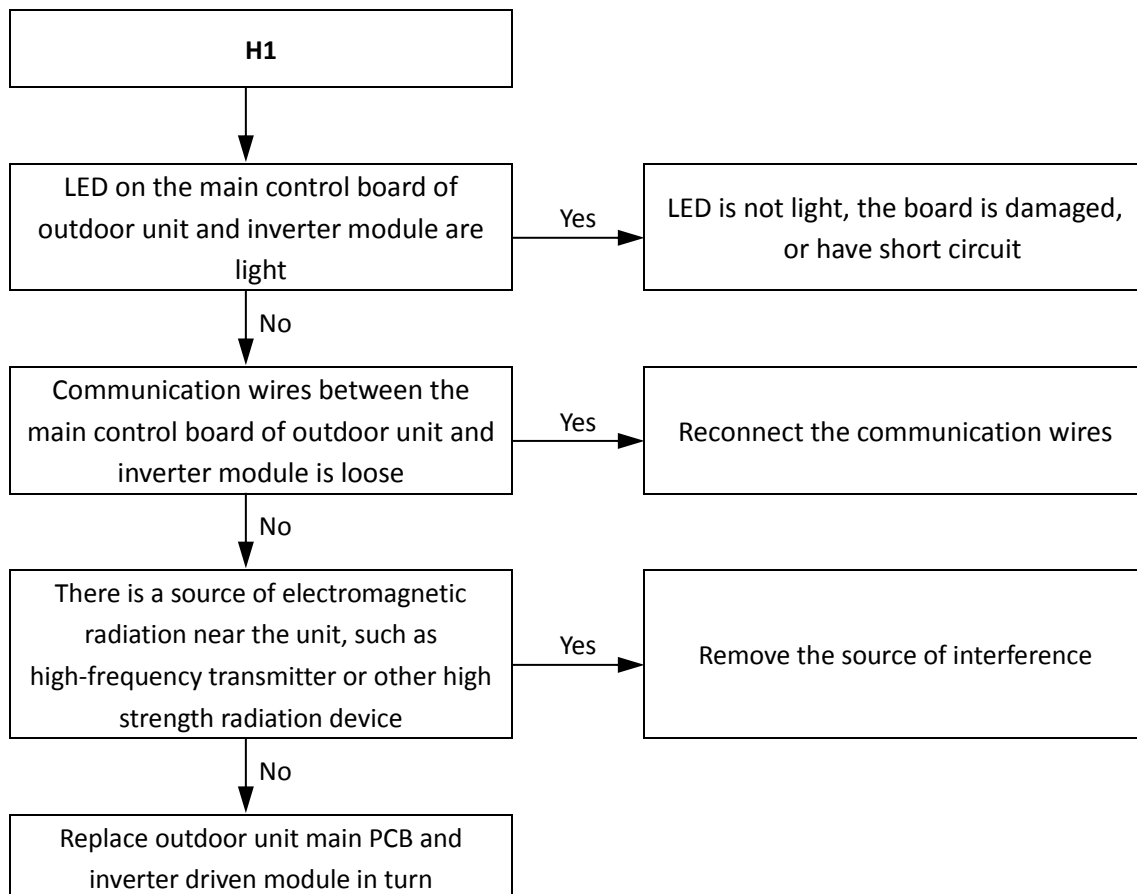

## 4.12 H6, HH Troubleshooting

### 4.12.1 Digital display output

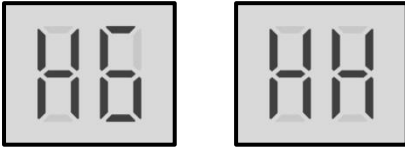

### 4.12.2 Description

- H6 indicates a DC fan error.
- HH indicates that H6 protection has occurred 10 times in 2 hours. When HH error occurs, a manual system restart is required before the system can resume operation. The cause of HH error should be addressed promptly in order to avoid system damage.
- OPTIMUS PRO Mono stops running.
- Error code is displayed on outdoor unit main PCB and user interface.

### 4.12.3 Possible causes

- DC fan wire is loosed.
- High wind speed.
- Fan motor blocked or has failed.
- Invert module damaged.
- Main PCB is damaged.

# OPTIMUS PRO Mono

## 4.12.4 Procedure

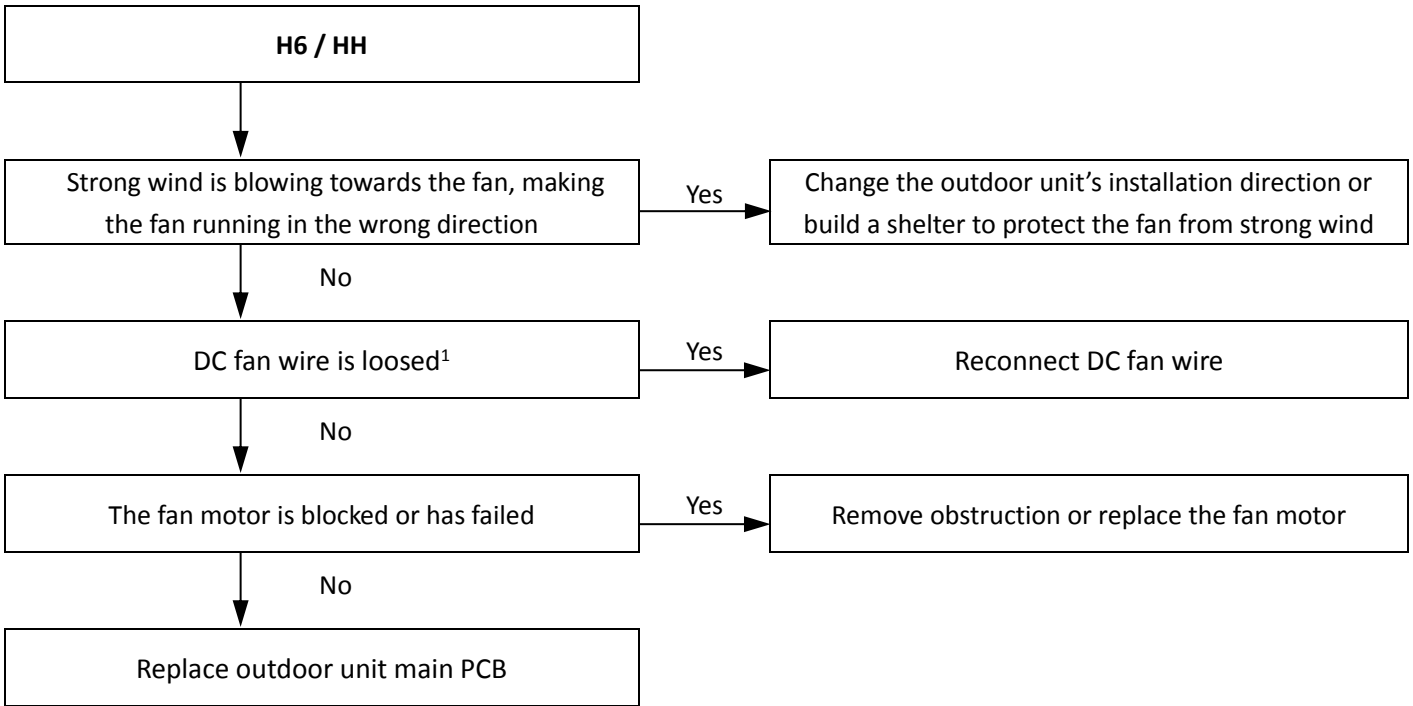

### Notes:

1. Refer to Figures 4-1.1 to 4-1.2 in "OPTIMUS PRO Mono Service Manual" and to Part 2 "Wiring Diagrams". in OPTIMUS PRO Mono Engineering Data Book,
2. Measure the voltage between the DC fan motor power supply's white and black wires. The normal voltage is 15V when the unit is in standby. If the voltage is significantly different from 15V, the IPM module on the inverter module is damaged. DC fan connection is CN107/109 on the outdoor unit refrigerant system main PCB (labeled 23 in Figure 4-2.2).

## 4.13 H7 Troubleshooting

### 4.13.1 Digital display output



### 4.13.2 Description

- Abnormal main circuit voltage.
- OPTIMUS PRO Mono stops running.
- Error code is displayed on outdoor unit main PCB and user interface.

### 4.13.3 Possible causes

- Power supply voltage not within 90%~110% of rated voltage.
- Outdoor unit main PCB is damaged.

### 4.13.4 Procedure

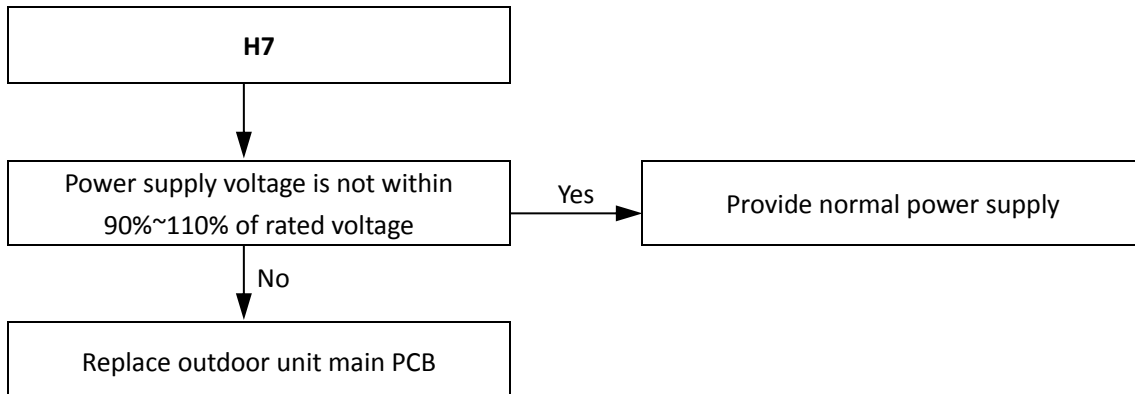

# OPTIMUS PRO Mono

## 4.14 H8 Troubleshooting

### 4.14.1 Digital display output



### 4.14.2 Description

- Pressure sensor error.
- OPTIMUS PRO Mono stops running.
- Error code is displayed on outdoor unit main PCB and user interface.

### 4.14.3 Possible causes

- Pressure sensor not connected properly or has malfunctioned.
- Outdoor unit main PCB is damaged.

### 4.14.4 Procedure

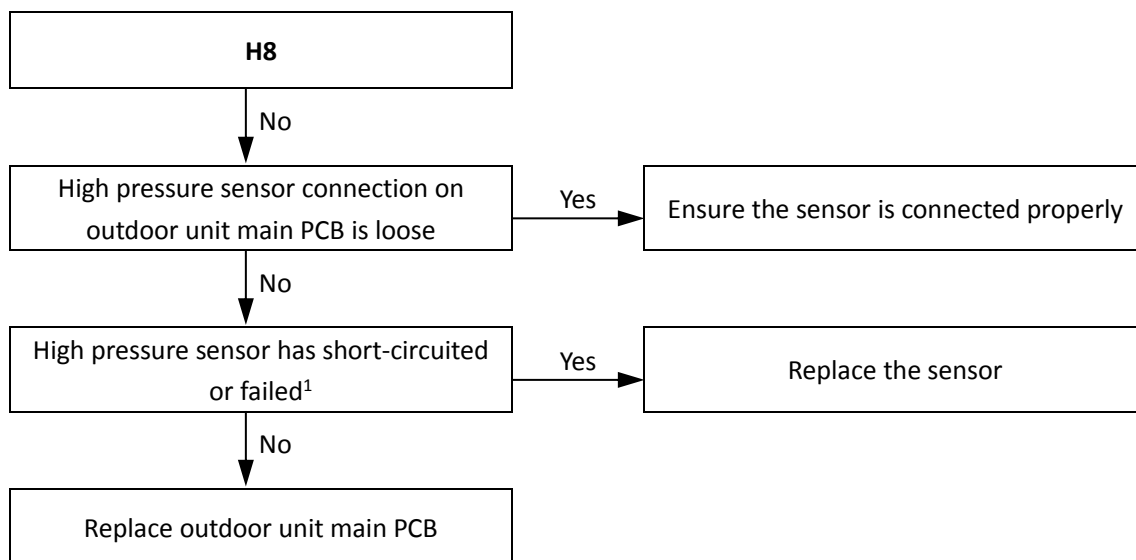

#### Notes:

1. Measure the resistance among the three terminals of the pressure sensor. If the resistance is of the order of mega Ohms or infinite, the pressure sensor has failed. The pressure sensor connection is port CN6 on the outdoor unit refrigerant system main PCB (labeled 3 in Figure 4-2.2).

## 4.15 P0, HP Troubleshooting

### 4.15.1 Digital display output

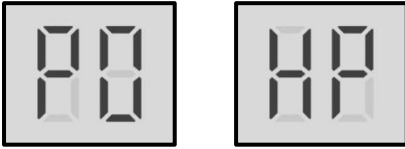

### 4.15.2 Description

- P0 indicates suction pipe low pressure protection. When the suction pressure falls below 0.14MPa, the system displays P0 protection and OPTIMUS PRO Mono stops running. When the pressure rises above 0.3MPa, P0 is removed and normal operation resumes.
- HP indicates  $P_e < 0.6\text{Mpa}$  occurred 3 times in an hour.
- Error code is displayed on outdoor unit main PCB and user interface.

### 4.15.3 Possible causes

- Low pressure switch not connected properly or has malfunctioned.
- Insufficient refrigerant.
- Low pressure side blockage.
- Poor evaporator heat exchange in heating mode or DHW mode.
- Insufficient water flow in cooling mode.
- Outdoor unit main PCB damaged.

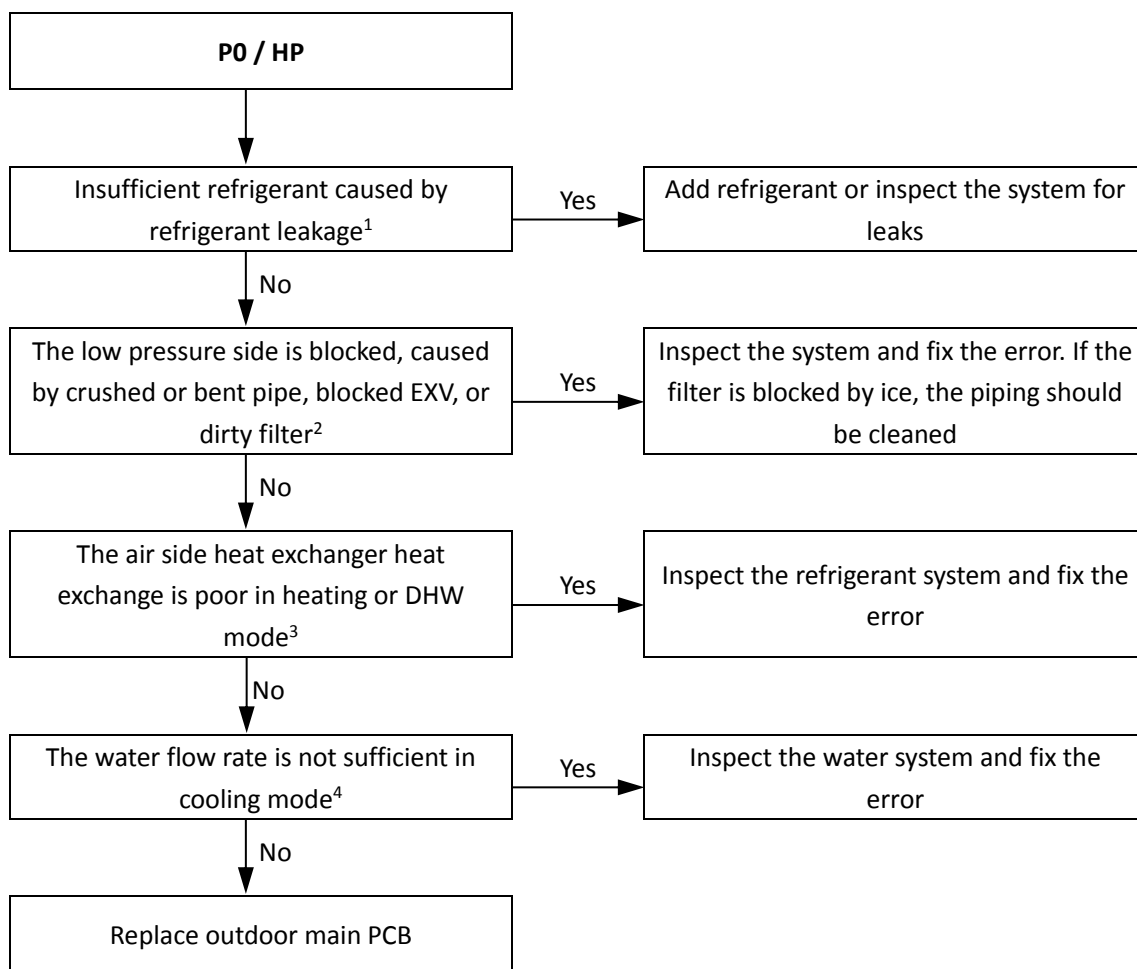

Notes:

1. To check for insufficient refrigerant:  
An insufficiency of refrigerant causes compressor discharge temperature to be higher than normal, discharge and suction pressures to be lower than normal and compressor current to be lower than normal, and may cause frosting to occur on the suction pipe. These issues disappear once sufficient refrigerant has been charged into the system.
2. A low pressure side blockage causes compressor discharge temperature to be higher than normal, suction pressure to be lower than normal and compressor current to be lower than normal, and may cause frosting to occur on the suction pipe. For normal system parameters.
3. Check air side heat exchanger, fan and air outlets for dirt/blockages.
4. Check water side heat exchanger, water piping, circulator pumps and water flow switch for dirt/blockages.

## 4.16 P1 Troubleshooting

### 4.16.1 Digital display output



### 4.16.2 Description

- Discharge pipe high pressure protection. When the discharge pressure rises above 4.2MPa, the system displays P1 protection and OPTIMUS PRO Mono stops running. When the discharge pressure falls below 3.2MPa, P1 is removed and normal operation resumes.
- Error code is displayed on outdoor unit main PCB and user interface.

### 4.16.3 Possible causes

- Pressure sensor/switch not connected properly or has malfunctioned.
- Excess refrigerant.
- System contains air or nitrogen.
- High pressure side blockage.
- Poor condenser heat exchange.
- Outdoor unit main PCB damaged.



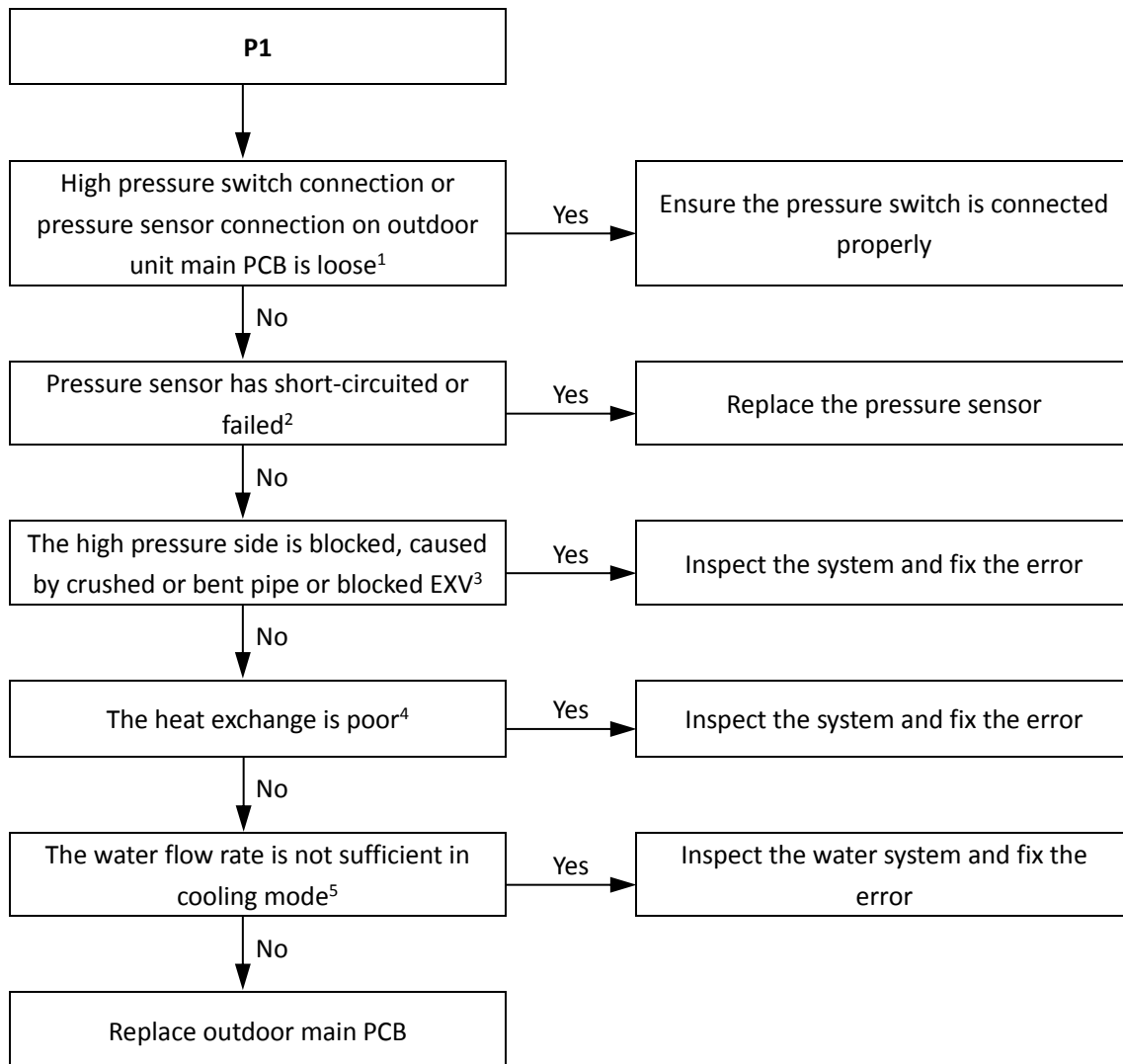

Notes:

1. High pressure switch connection is port CN31 on the outdoor unit refrigerant system main PCB (labeled 21 in Figure 4-2.2).
2. Measure the resistance among the three terminals of the pressure sensor. If the resistance is of the order of mega Ohms or infinite, the pressure sensor has failed.
3. High pressure side blockage causes discharge temperature to be higher than normal, discharge pressure to be higher than normal and suction pressure to be lower than normal.
4. In heating mode check water side heat exchanger, water piping, circulator pumps and water flow switch for dirt/blockages. In cooling mode check air side heat exchanger, fan(s) and air outlets for dirt/blockages.
5. Check water pressure on the manometer. If the water pressure is not > 1 bar, water flow is insufficient. Refer to Figure 2-1.1.

## 4.17 P3 Troubleshooting

### 4.17.1 Digital display output



### 4.17.2 Description

- Compressor current protection.
- When the compressor current rises above the protection value (28A), the system displays P3 protection and OPTIMUS PRO Mono stops running. When the current returns to the normal range, P3 is removed and normal operation resumes.
- Error code is displayed on refrigerant system main PCB and user interface.

### 4.17.3 Possible causes

- Poor condenser heat exchange.
- High pressure side blockage.
- Inverter module damaged.
- Compressor damaged.
- Outdoor unit main PCB damaged.

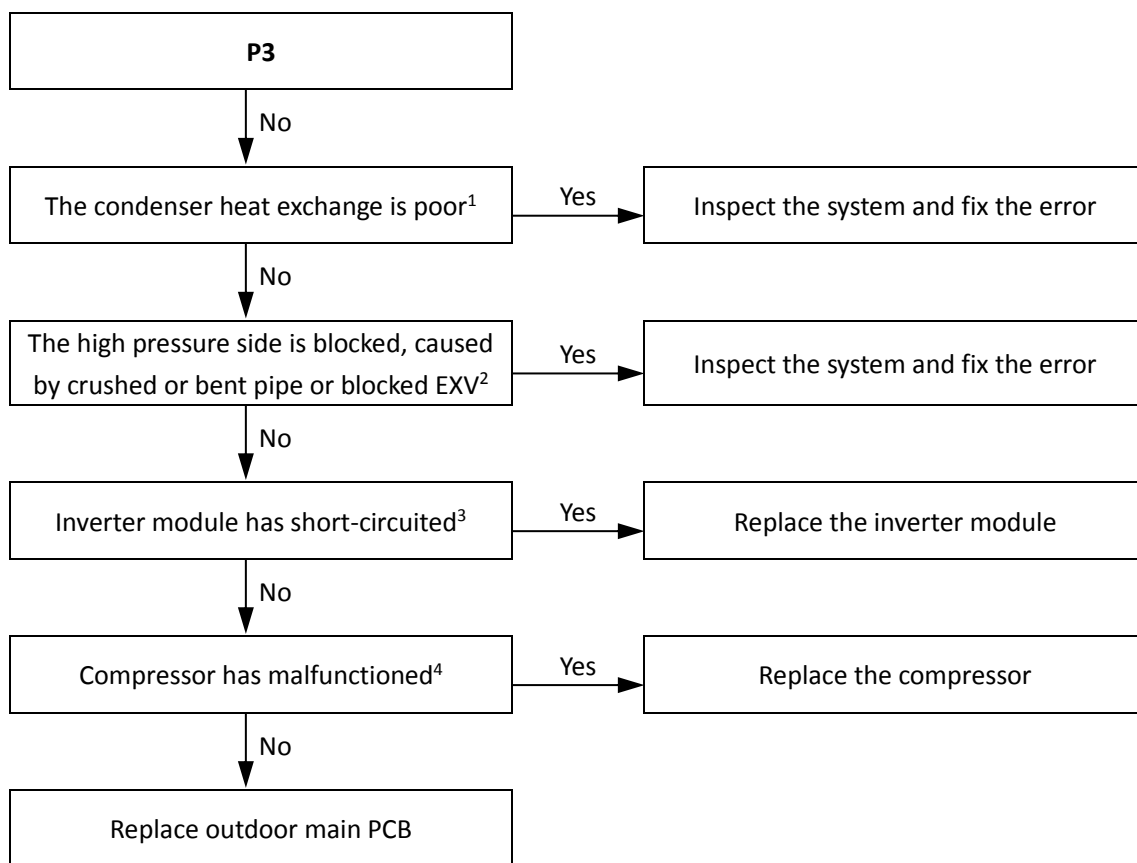

Notes:

1. In heating mode check water side heat exchanger, water piping, circulator pumps and water flow switch for dirt/blockages. In cooling mode check air side heat exchanger, fan and air outlets for dirt/blockages.
2. High pressure side blockage causes discharge temperature to be higher than normal, discharge pressure to be higher than normal and suction pressure to be lower than normal.
3. Set a multi-meter to buzzer mode and test any two terminals of P N and U V W of the inverter module. If the buzzer sounds, the inverter module has short-circuited.
4. The normal resistances of the inverter compressor are 0.7-1.5Ω among U V W and infinite between each of U V W and ground. If any of the resistances differ from these specifications, the compressor has malfunctioned.

## 4.18 P4 Troubleshooting

### 4.18.1 Digital display output



### 4.18.2 Description

- Discharge temperature protection.
- When the compressor the discharge temperature rises above 115°C, the system displays P4 protection and OPTIMUS PRO Mono stops running. When the discharge temperature falls below 90°C, P4 is removed and normal operation resumes.
- Error code is displayed on refrigerant system main PCB and user interface.

### 4.18.3 Possible causes

- Temperature sensor error.
- High pressure side blockage.
- Poor condenser heat exchange.
- Outdoor unit main PCB damaged.

# OPTIMUS PRO Mono

## 4.18.4 Procedure

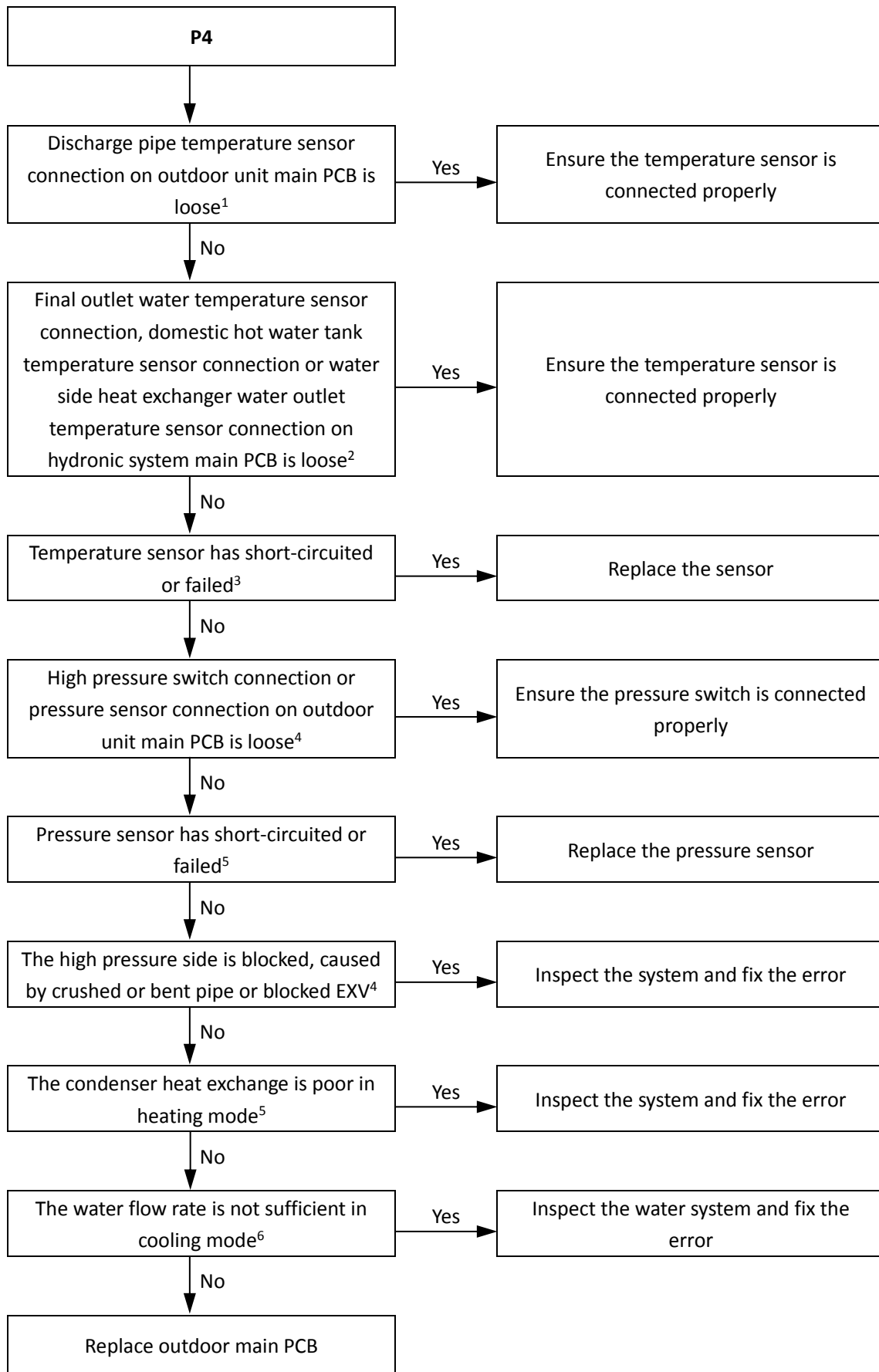

Notes:

1. Discharge pipe temperature sensor connection is port CN8 on the outdoor unit refrigerant system main PCB (labeled 5 in Figure 4-2.2).
2. Final outlet water temperature sensor and water side heat exchanger water outlet temperature sensor connections are port CN6 on the hydronic system

main PCB (labeled 10 in Figure 4-2.1). Domestic hot water tank temperature sensor connection is port CN13 on hydronic system main PCB (labeled 13 in Figure 4-2.1).

3. Set a multi-meter to buzzer mode and test any two terminals of sensor. If the resistance is too low, the buzzer sounds, which means the sensor has short-circuited. If the resistance is not consistent with the sensor's resistance characteristics table, the sensor has failed. Refer to Part 2, 1 "Layout of Functional Components" and to Table 5-5.1 or 5-5.2 in Part 5, 5.1 "Temperature Sensor Resistance Characteristics".
4. High pressure switch connection is port CN31 on the outdoor unit refrigerant system main PCB (labeled 21 in Figure 4-2.2). Measure the resistance among the three terminals of the pressure sensor. If the resistance is of the order of mega Ohms or infinite, the pressure sensor has failed.  
High pressure side blockage causes discharge temperature to be higher than normal, discharge pressure to be higher than normal and suction pressure to be lower than normal.
5. Check air side heat exchanger, fan and air outlets for dirt/blockages.
6. Check the water side heat exchanger, water piping, circulator pumps and water flow switch for dirt/blockages.

## OPTIMUS PRO Mono

### 4.19 P5 Troubleshooting

#### 4.19.1 Digital display output



#### 4.19.2 Description

- High temperature difference between water side heat exchanger water inlet and water outlet temperatures protection.
- OPTIMUS PRO Mono stops running.
- Error code is displayed on hydronic system main PCB and user interface.

#### 4.19.3 Possible causes

- Temperature sensor not connected properly or has malfunctioned.
- Water piping contains air.
- Insufficient water flow.
- Hydronic system main PCB damaged.

## 4.19.4 Procedure

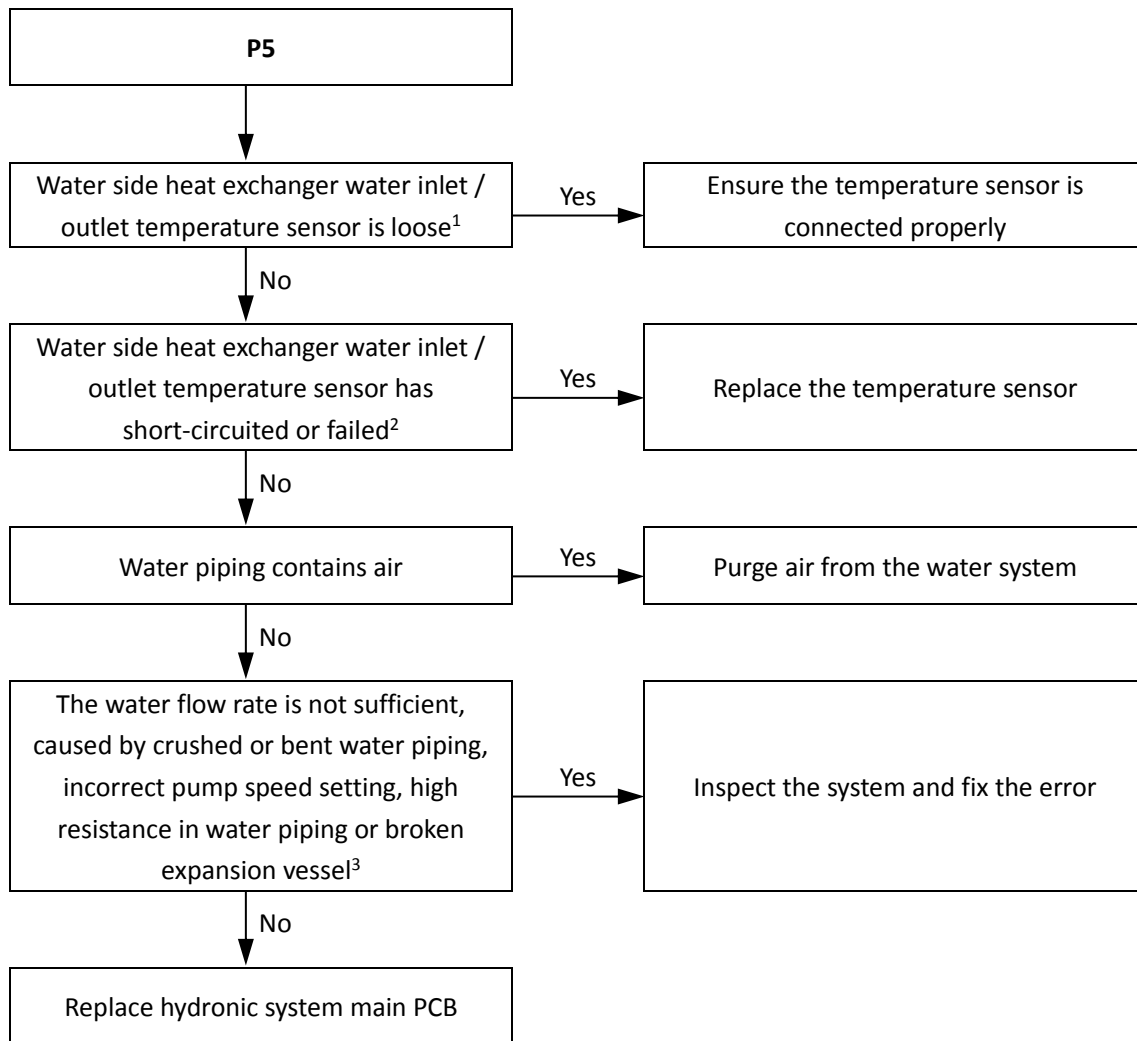

## Notes:

1. Water side heat exchanger water inlet temperature sensor and water side heat exchanger water outlet temperature sensor connections are port CN6 on the hydronic system main PCB (labeled 10 in Figure 4-2.1).
2. Set a multi-meter to buzzer mode and test any two terminals of sensor. If the resistance is too low, the buzzer sounds, which means the sensor has short-circuited. If the resistance is not consistent with the sensor's resistance characteristics table, the sensor has failed. Refer to Table 5-5.3.
3. Check water pressure on the manometer. If the water pressure is not > 1 bar, water flow is insufficient. Refer to Figures 2-1.1.



# OPTIMUS PRO Mono

## 4.20 Inverter module Troubleshooting

### 4.20.1 Digital display output

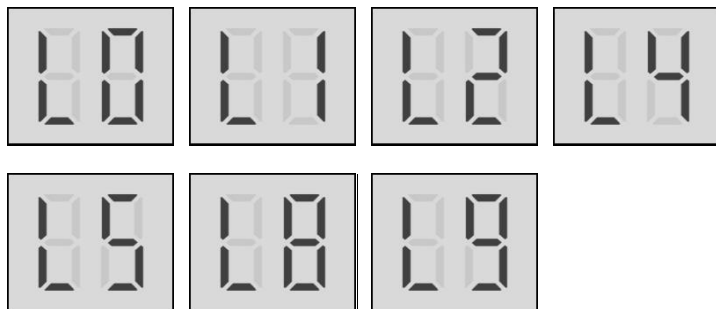

### 4.20.2 Description

- Inverter module protection or high pressure protection.
- OPTIMUS PRO Mono stops running.
- Specific error code L0, L1, L2, L4, L5, L8 , L9 is displayed on the user interface and the refrigerant system main PCB.

### 4.20.3 Possible causes

- Inverter module protection.
- DC bus low or high voltage protection.
- MCE error(DC bus low or high voltage protection or software over current protection)
- Zero speed protection.
- Excessive compressor frequency variation.
- Actual compressor frequency differs from target frequency.
- High pressure protection.
- Contactor stuck or 908 self checking fail.

### 4.20.4 Specific error codes for inverter module protection

Table 4-4.1: Specific error codes

Specific error code	Content
L0	Inverter module protection
L1	DC bus low voltage protection
L2	DC bus high voltage protection
L4	MCE error(DC bus low or high voltage protection or software over current protection)
L5	Zero speed protection
L8	Compressor frequency variation greater than 15Hz within one second protection
L9	Actual compressor frequency differs from target frequency by more than 15Hz protection

The specific error codes can also be obtained from the LED indicators LED1/LED2 on the inverter module.

Table 4-4.2: Errors indicated on LED for 18/22/26/30kW unit

LED1/2 flashing pattern	Corresponding error
Flashes 8 times and stops for 1 second, then repeats	L0 - Inverter module protection
Flashes 9 times and stops for 1 second, then repeats	L1 - DC bus low voltage protection
Flashes 10 times and stops for 1 second, then repeats	L2 - DC bus high voltage protection
Flashes 12 times and stops for 1 second, then repeats	L4 - MCE error(DC bus low or high voltage protection or software over current protection)
Flashes 13 times and stops for 1 second, then repeats	L5 - Zero speed protection
Flashes 17 times and stops for 1 second, then repeats	L8 - Compressor frequency variation greater than 15Hz within one second protection L9 - Actual compressor frequency differs from target frequency by more than 15Hz protection
Flashes 3 times and stops for 1 second, then repeats	bH - Contactor stuck or 908 self checking fail
Flashes 5 times and stops for 1 second, then repeats	P1 - High pressure protection

Figure 4-4.1: LED location of inverter module for three-phase 18/22/26/30kW unit

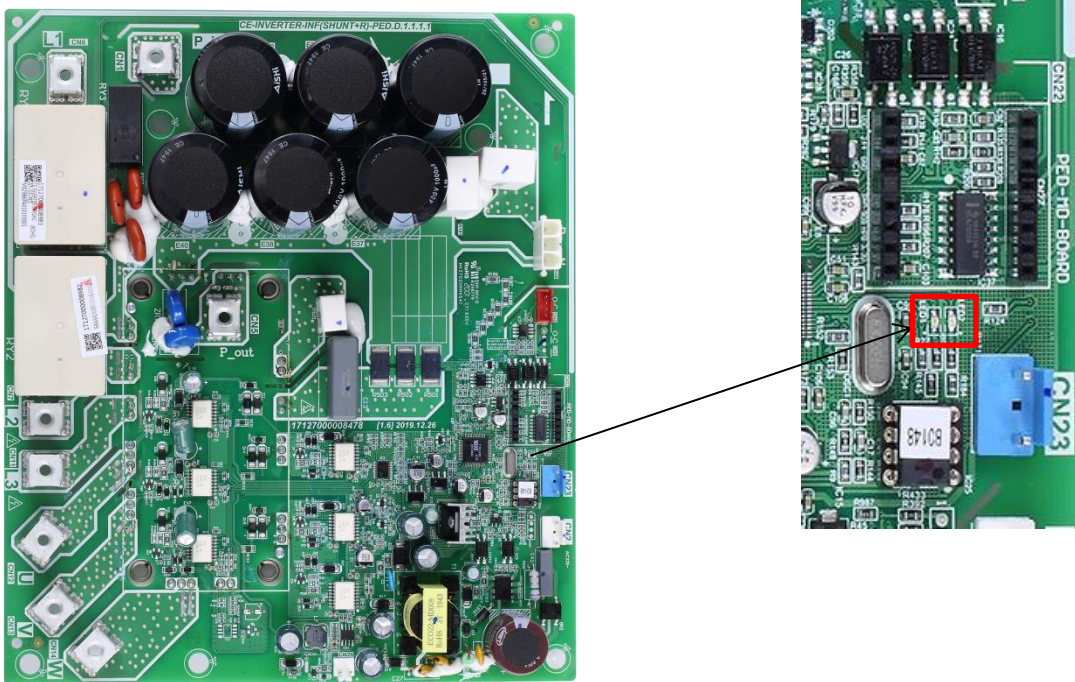

## 4.20.5 Principle of DC inverter

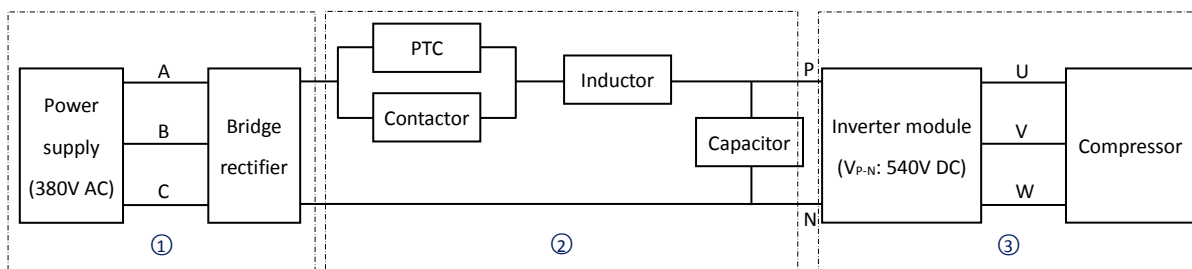

- ① 380-415V AC power supply change to DC power supply after bridge rectifier.
- ② Contactor is open the current across the PTC to charge capacitor, after 5 seconds the contactor closed.
- ③ The capacitor output steady 540V DC power supply for inverter module P N terminals.

# OPTIMUS PRO Mono

## 4.20.6 L0 troubleshooting

### Situation 1: L0 error appears immediately after the outdoor unit is powered-on

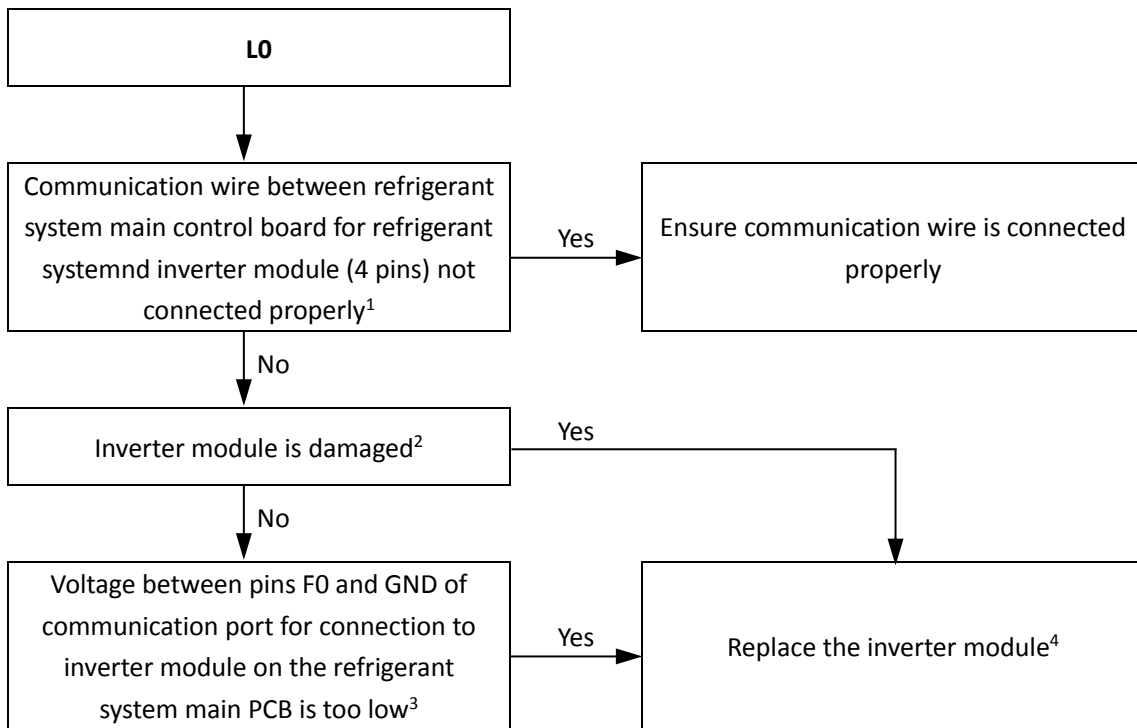

Notes:

1. The communication port between refrigerant system main control board for refrigerant system inverter module is port CN36 on refrigerant system main control board for refrigerant system port CN8 on inverter module.
2. Measure the resistance between each of U, V and W and each of P and N on the inverter module. All the resistances should be infinite. If any of them are not infinite, the inverter module is damaged and should be replaced.
3. The normal voltage between F0 and GND is 5V. Refer to Figure 4-4.2.
4. When replacing an inverter module, a layer of thermally conductive silica gel should be painted on the IPM module (on the reverse side of the inverter module PCB). Refer to Figure 4-4.3.

Figure 4-4.2: F0 and GND voltage on IC28-1 (F0), IC28-4 (GND)

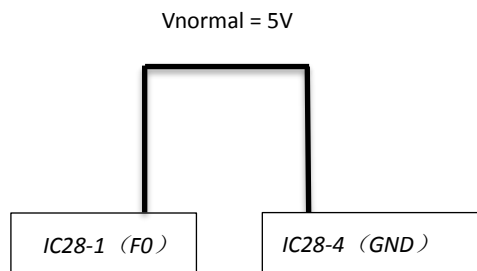
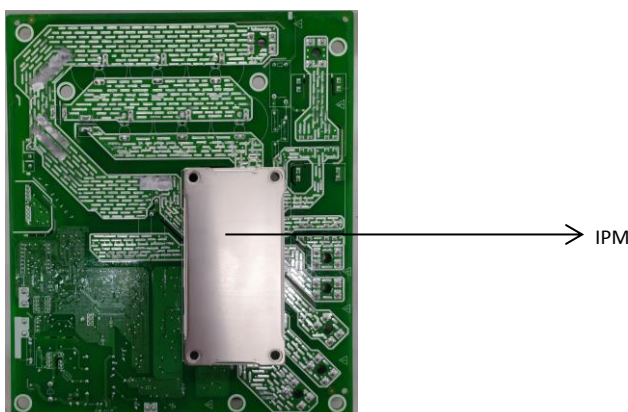
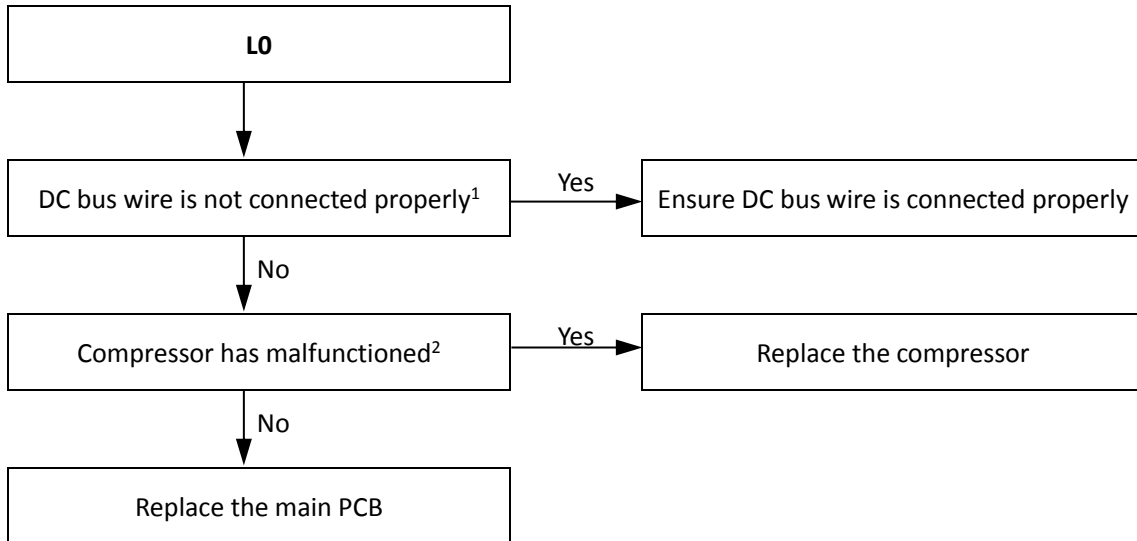

Figure 4-4.3: Replacing an inverter module



Situation 2: L0 error appears immediately after the compressor starts up



Notes:

1. The DC bus wire should run from the N terminal on the inverter module, through the current sensor (in the direction indicated by the arrow on the current sensor), and end at the N terminal of capacitor. Refer to Figure 4-4.4.

Figure 4-4.4: DC bus wire connection (L1L2L3,PIN- POUT)

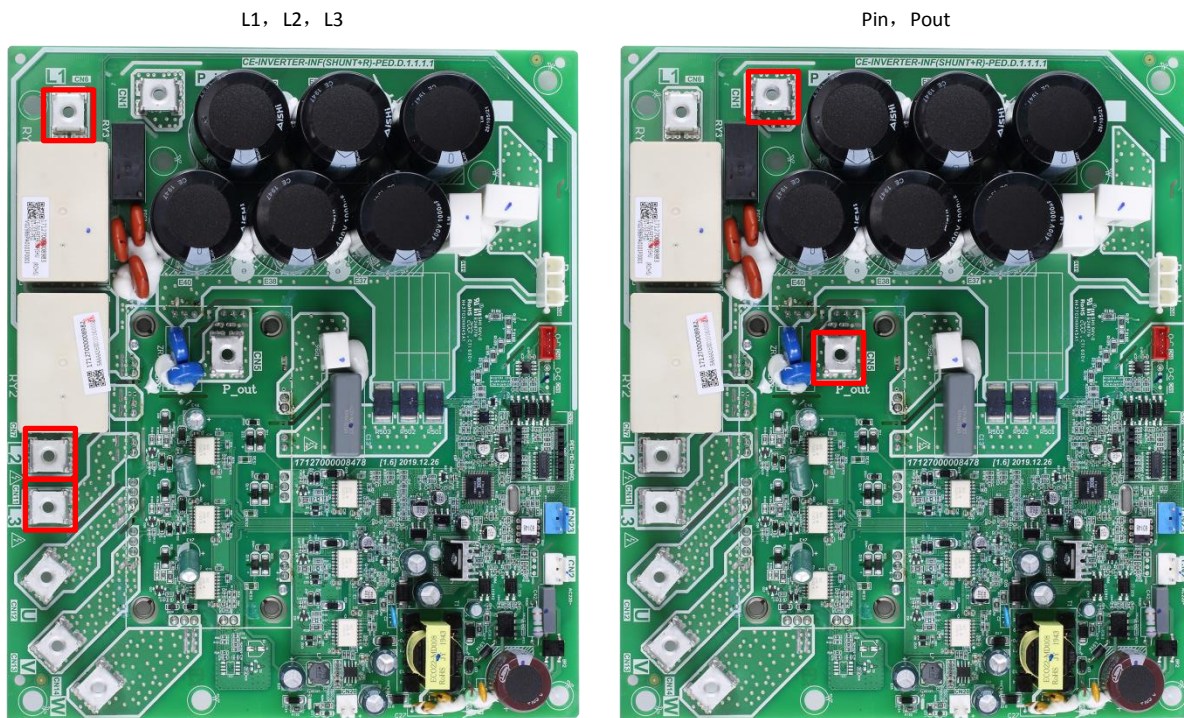

2. The normal resistances of the inverter compressor are 0.7-1.5Ω among U V W and infinite between each of U V W and ground. If any of the resistances differ from these specifications, the compressor has malfunctioned.

# OPTIMUS PRO Mono

## Situation 3: L0 error appears within 2 seconds of compressor start-up

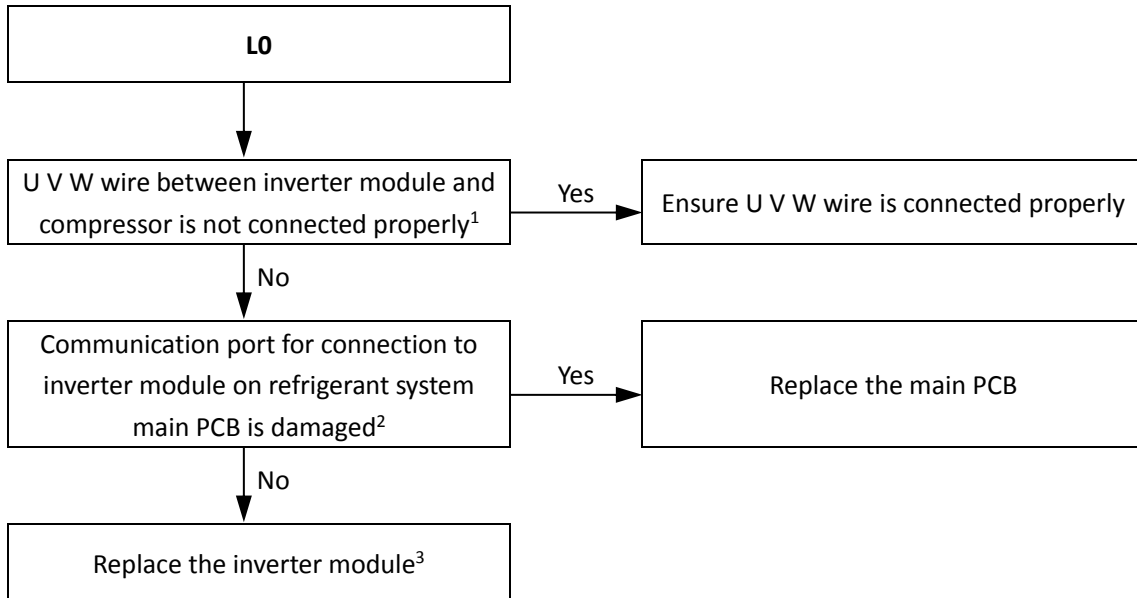

### Notes:

1. Connect the U V W wire from the inverter module to the correct compressor terminals, as indicated by the labels on the compressor.
2. Measure the voltage between each of W-, W+, V-, V+, U-, U+ and GND when the unit is in standby. The normal voltage should be 2.5V-4V and the six voltages should be same, otherwise the communication terminal has failed. Refer to Figure4-4.5.

Figure 4-4.5: Connection port for inverter module

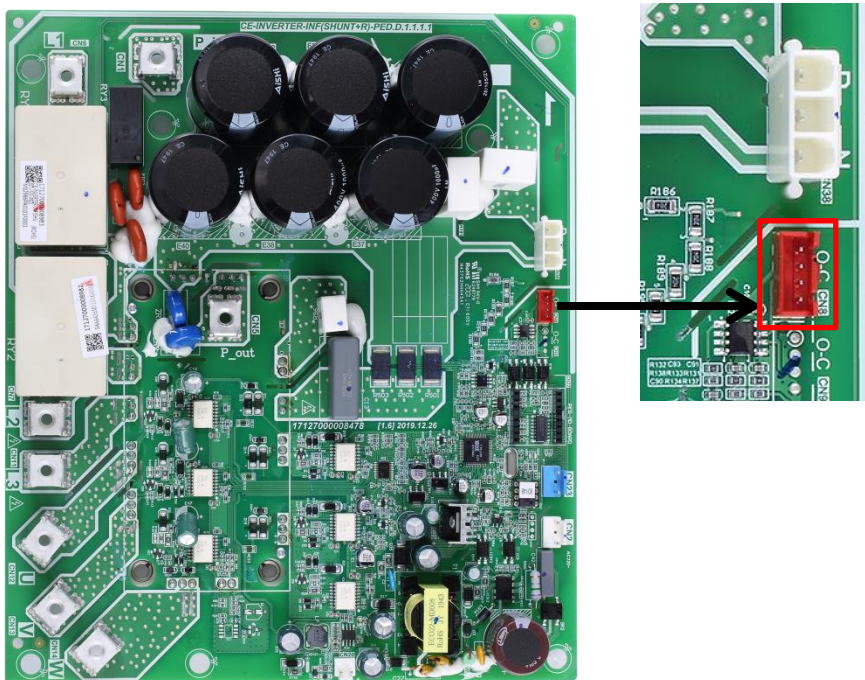

3. When replacing an inverter module, a layer of thermally conductive silica gel should be painted on the IPM module (on the reverse side of the inverter module PCB). Refer to Figure 4-4.3.

**Condition 4: L0 error appears after the compressor has been running for a period of time and the compressor speed is over 60rps**

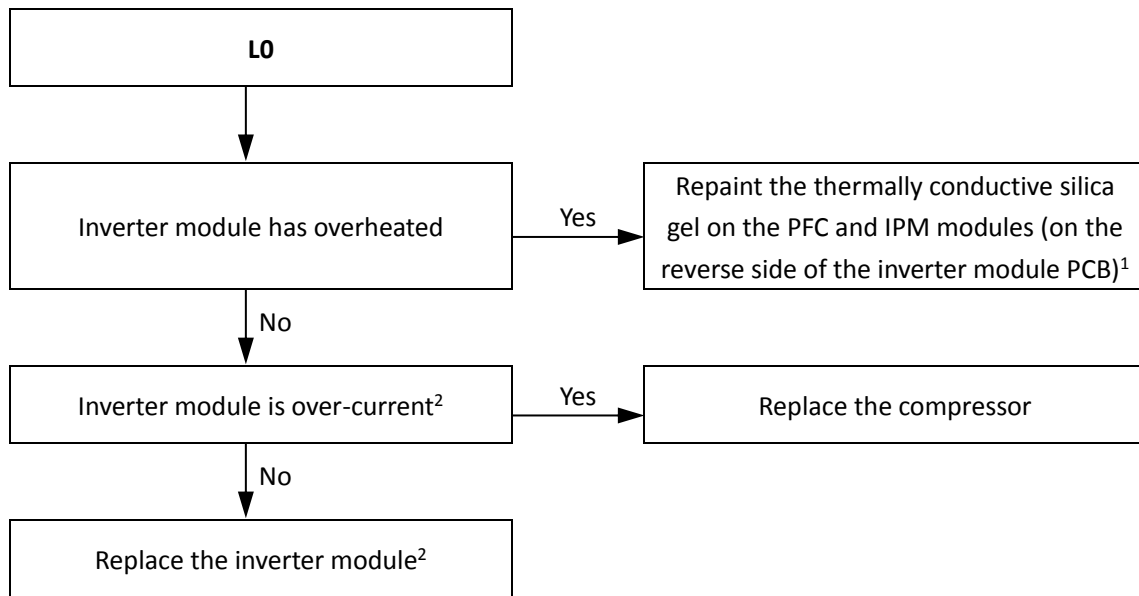

Notes:

1. When replacing an inverter module, a layer of thermally conductive silica gel should be painted on the IPM module (on the reverse side of the inverter module PCB). Refer to Figure 4-4.3.
2. Use clip-on ammeter to measure the compressor current, if the current is normal indicates the inverter module is failed, if the current is abnormal indicates the compressor has failed.

**Situation 5: L0 error appears occasionally/irregularly**

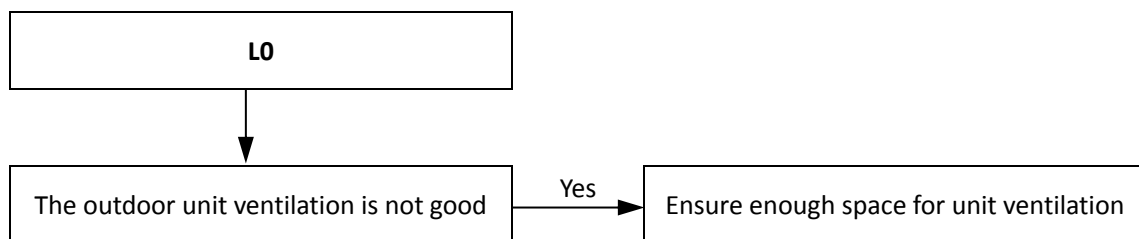



# OPTIMUS PRO Mono

## 4.20.7 L1/L2 troubleshooting

The normal DC voltage between terminals P and N on inverter module is 540V. If the voltage is lower than 300V, the unit displays an L1 error; if the voltage is higher than 830V, the unit displays an L2 error. Refer to Figure4-4.6.

Figure 4-4.6: P, N terminals voltage

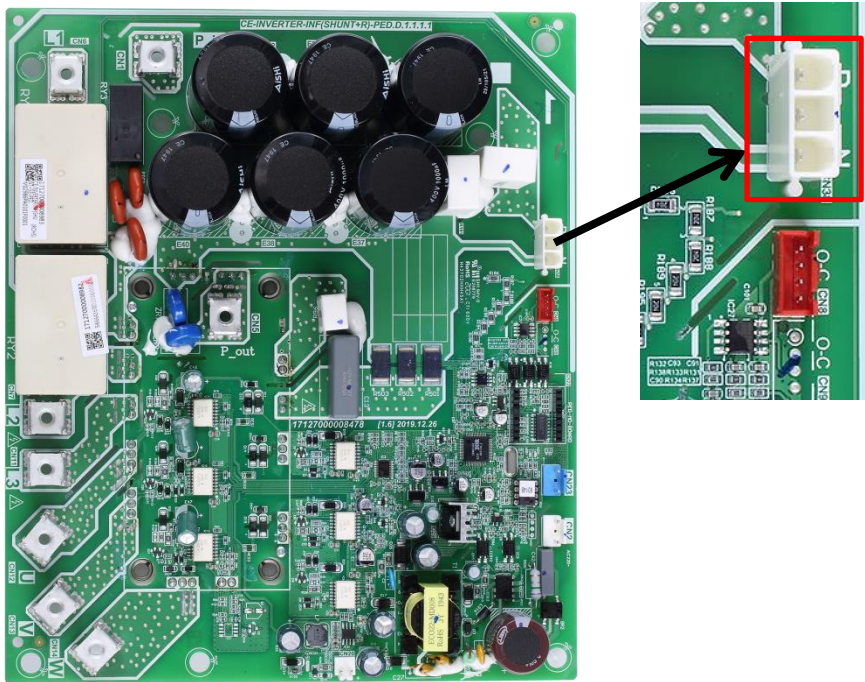

$V_{\text{normal}} = 540\text{V DC}$

### Situation 1: L1 or L2 error appears immediately after the outdoor unit is powered-on

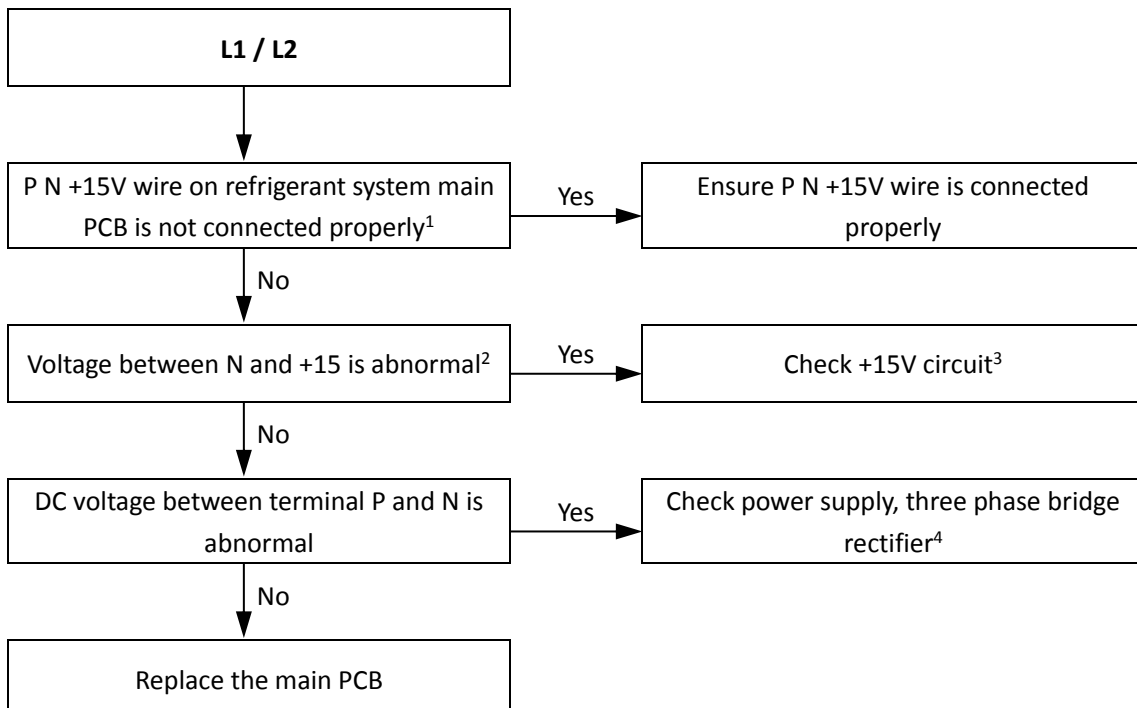

Notes:

1. P N +15V terminal on refrigerant system main PCB. Refer to Figure4-4.9.
2. Voltage between N and +15. Refer to Figure4-4.7

Figure 4-4.7: P N +15V terminal+15V (IC4/5/6PIN12); N- (IC/4/5, 6) PIN13

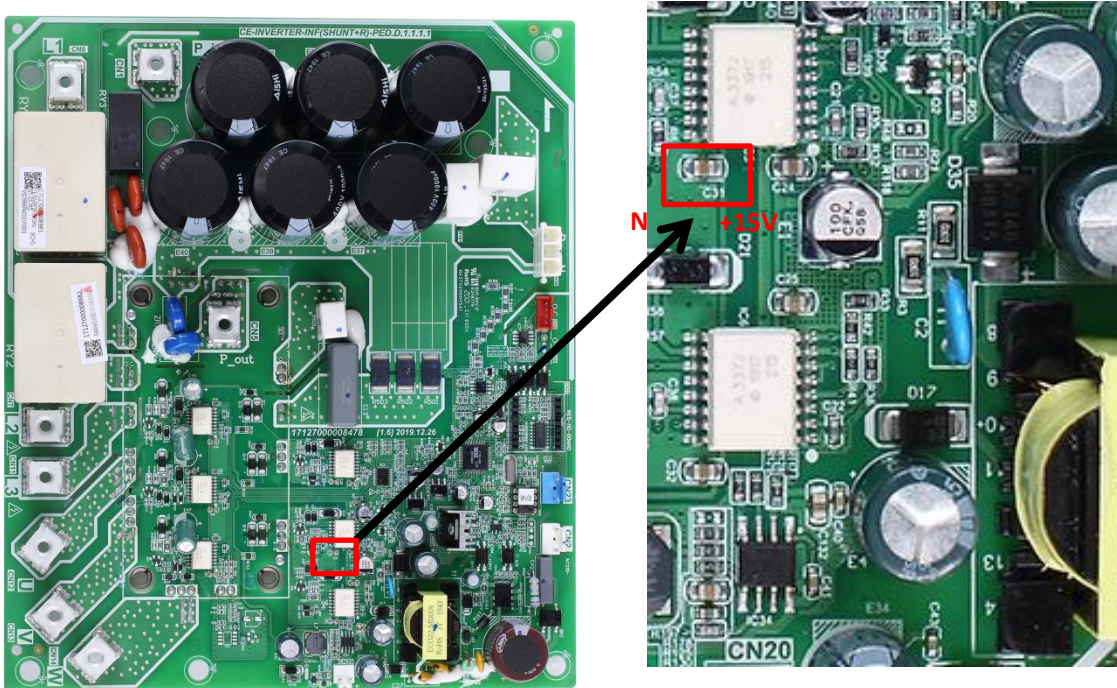

3. Check the +15V circuit according to corresponding wiring diagram. If IC4/5/6PIN12 on inverter module output voltage is not +15V means the inverter module is failed. If voltage output of inverter module is +15V means main PCB is failed.
4. Check the bridge rectifier using one of the following two methods (refer to Figure 4-4.8):
  - Method 1: measure the resistance between any two of the 5 bridge rectifier terminals. If any of the resistances is close to zero, the bridge rectifier has failed.
  - Method 2: dial a multimeter to the diode setting:
    - Put the red probe on the DC power output negative terminal (terminal 5) and put the black probe onto each of the AC power input terminals (terminals 1, 2 and 3) in turn. The voltage between terminal 5 and each of terminals 1, 2 and 3 should be around 0.378V. If the voltage is 0, the bridge rectifier has failed.
    - Put the red probe on the DC power output positive terminal (terminal 4), then put black probe onto each of the AC power input terminals (terminals 1, 2 and 3) in turn. The voltage between terminal 4 and each of terminals 1, 2 and 3 should be infinite. If the voltage is 0, the bridge rectifier has failed.

Figure 4-4.8: Bridge rectifier

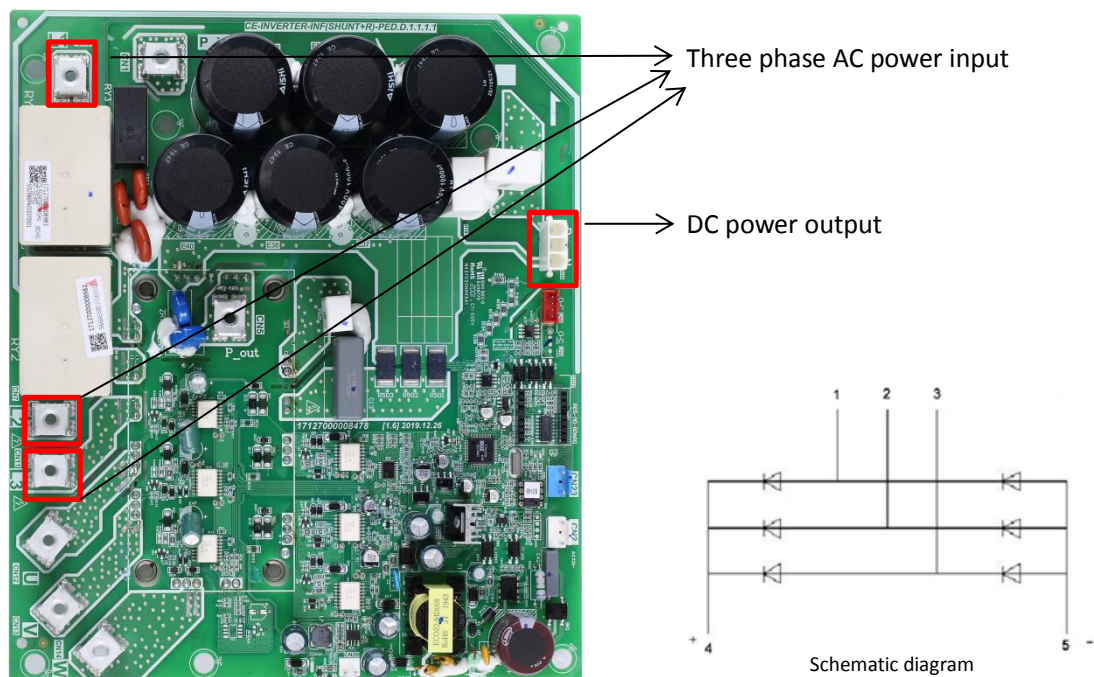



# OPTIMUS PRO Mono

## 4.20.8 L4 troubleshooting(the same as L1/L2)

Situation 1: L4 error appears immediately after the outdoor unit is powered-on

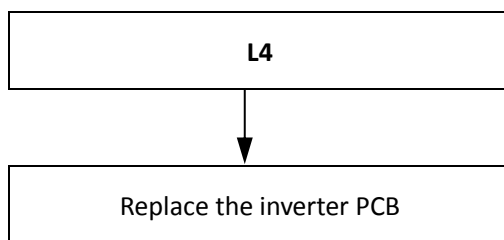

Condition 2: L4 error appears after the compressor has been running for a period of time and the compressor speed is over 60rps

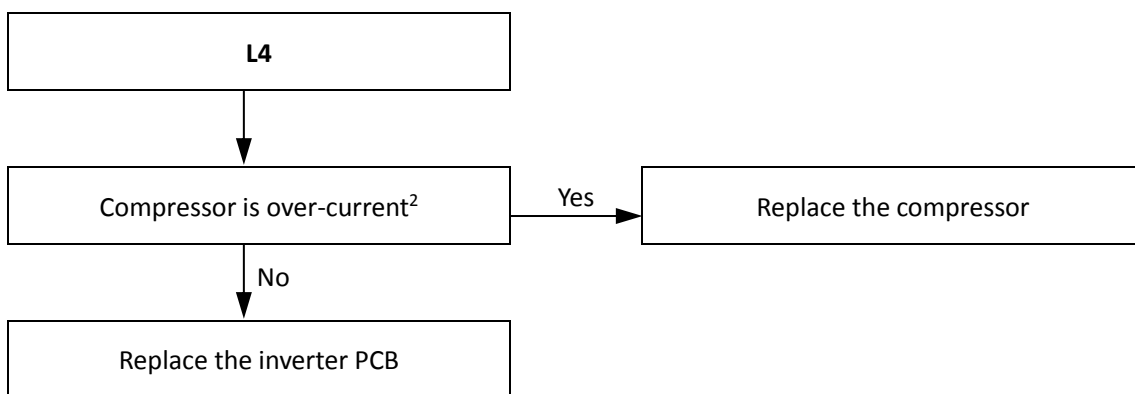

Notes:

1. Re-start the unit, use clip-on ammeter to measure the compressor current, if the current is normal indicates the compressor is failed, if the current is abnormal indicates the inverter PCB is failed..

## 4.20.9 L5/L8/L9 troubleshooting

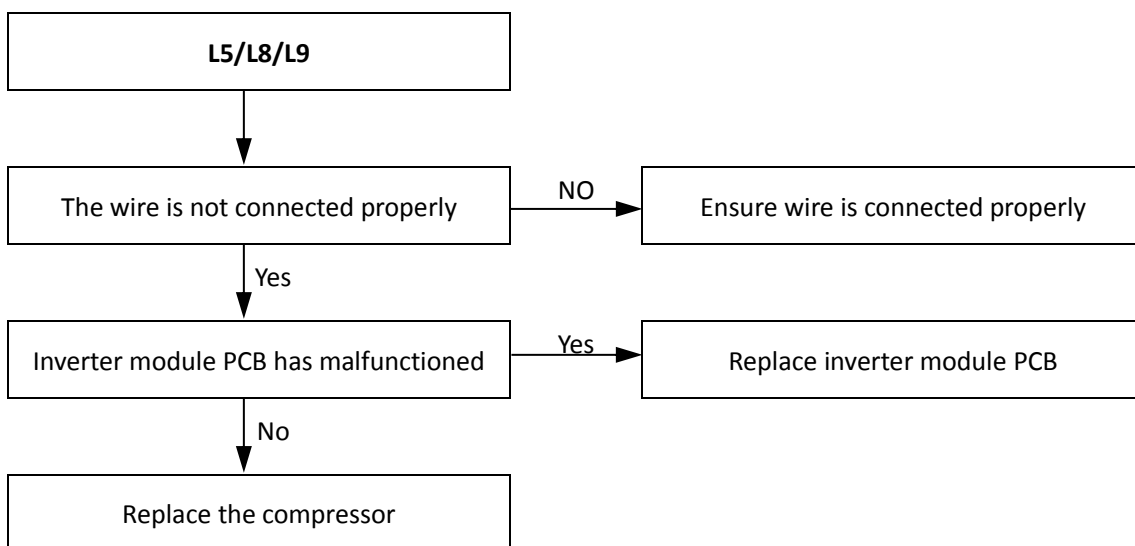

## 4.21 Pd Troubleshooting

### 4.21.1 Digital display output



### 4.21.2 Description

- High temperature protection of air side heat exchanger refrigerant outlet in cooling mode. When the air side heat exchanger refrigerant outlet temperature is higher than 61°C for more than 3 seconds, the system displays Pd protection and OPTIMUS PRO Mono stops running. When the air side heat exchanger refrigerant outlet temperature returns drops below 55°C, Pd is removed and normal operation resumes.
- OPTIMUS PRO Mono stops running.
- Error code is displayed on outdoor unit main PCB and user interface.

### 4.21.3 Possible causes

- Temperature sensor not connected properly or has malfunctioned.
- Poor condenser heat exchange.
- Fan motor damaged.
- Hydronic system main PCB damaged.

## 4.21.4 Procedure

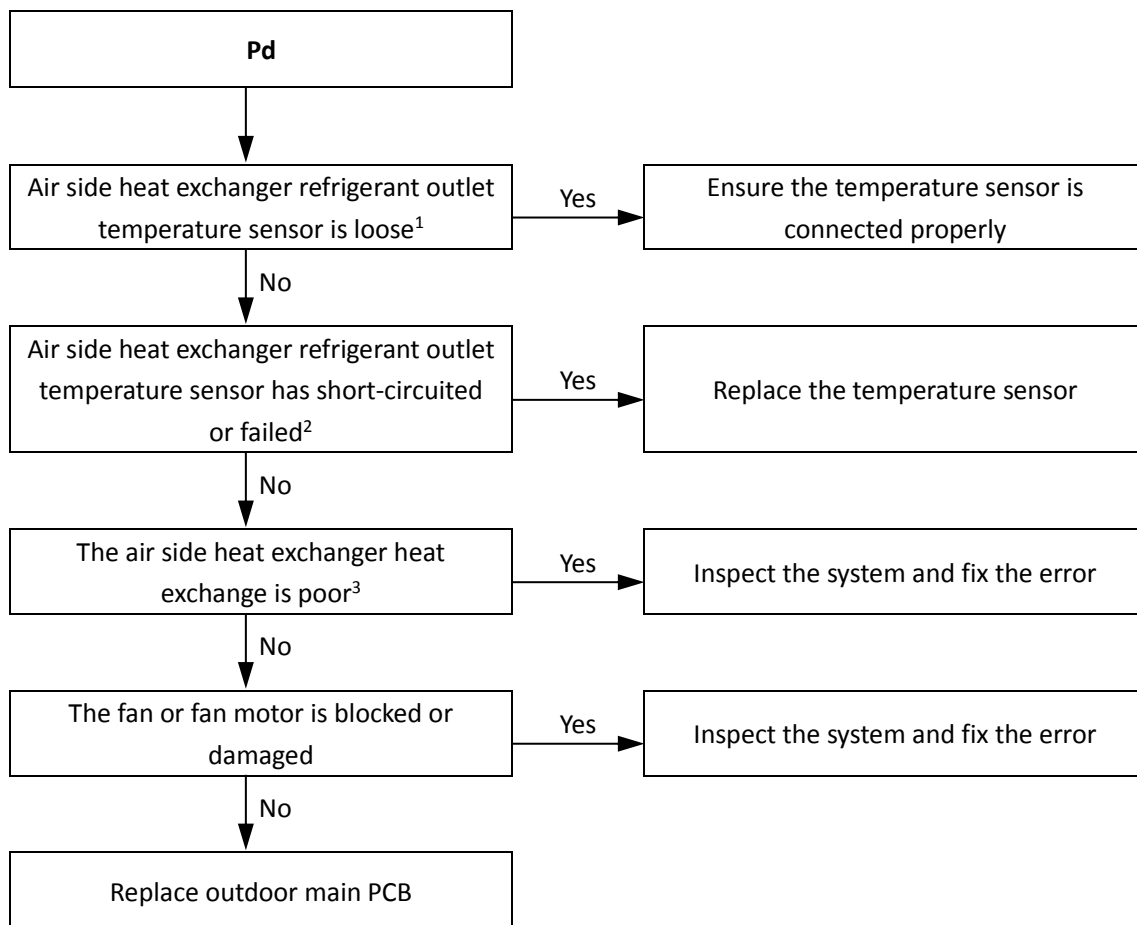

Notes:

1. Air side heat exchanger refrigerant outlet temperature sensor and outdoor ambient temperature sensor connection port are CN9 on the outdoor unit refrigerant system main PCB (labeled 6 in Figure 4-2.2)
2. Set a multi-meter to buzzer mode and test any two terminals of sensor. If the resistance is too low, the buzzer sounds, which means the sensor has short-circuited. If the resistance is not consistent with the sensor's resistance characteristics table, the sensor has failed. Refer to Table 4-5.1.
3. Check air side heat exchanger, fan and air outlets for dirt/blockages.
4. High pressure switch connection is port CN31 on the outdoor unit refrigerant system main PCB (labeled 21 in Figure 4-2.2)

## 4.22 PP Troubleshooting

### 4.22.1 Digital display output

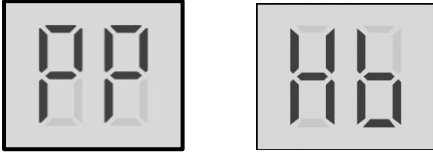

### 4.22.2 Description

- Water side heat exchanger inlet temperature is higher than outlet temperature in heating mode.
- OPTIMUS PRO Mono stops running.
- Error code is displayed on hydronic system main PCB and user interface.
- Hb indicates PP has displayed 3 times.

### 4.22.3 Possible causes

- Temperature sensor not connected properly or has malfunctioned.
- 4-way valve is blocked or damaged.
- Hydronic system main PCB damaged.

# OPTIMUS PRO Mono

## 4.22.4 Procedure

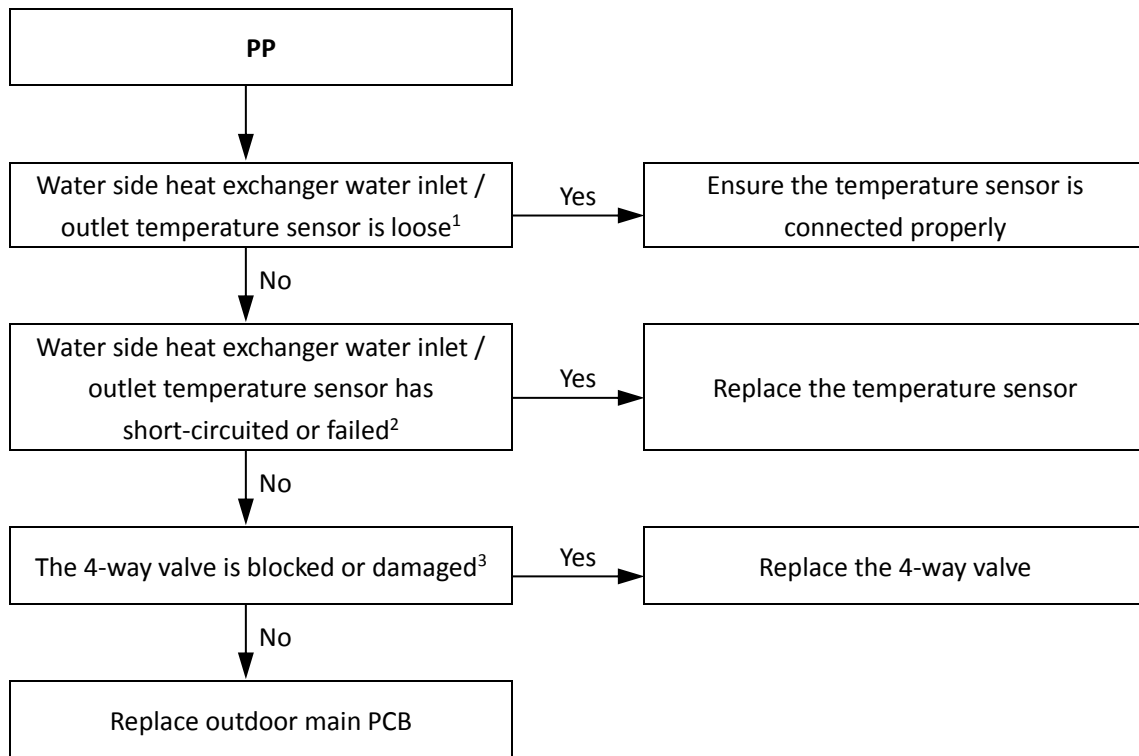

### Notes:

1. Water side heat exchanger water inlet temperature sensor and water side heat exchanger water outlet temperature sensor connections are port CN6 on the hydronic system main PCB (labeled 10 in Figure 4-2.1).
2. Set a multi-meter to buzzer mode and test any two terminals of sensor. If the resistance is too low, the buzzer sounds, which means the sensor has short-circuited. If the resistance is not consistent with the sensor's resistance characteristics table, the sensor has failed. Refer to Table 4-5.3
3. Restart the unit in cooling mode to change the refrigerant flow direction. If the unit does not operate normally, the 4-way valve is blocked or damaged.

## 4.23 C7 Troubleshooting

### 4.23.1 Digital display output



### 4.23.2 Description

- Transducer module temperature too high protection
- OPTIMUS PRO Mono stops running.
- Error code is displayed on hydronic system main PCB and user interface.

### 4.23.3 Possible causes

- Power supply voltage of the unit is low.
- The space between the units is too narrow for heat exchanger.
- Heat exchanger is dirty or something is block on the surface.
- Fan is not running.
- Water flow rate is low.
- Water outlet temp. sensor is loosen or broken.

## 4.23.4 Procedure

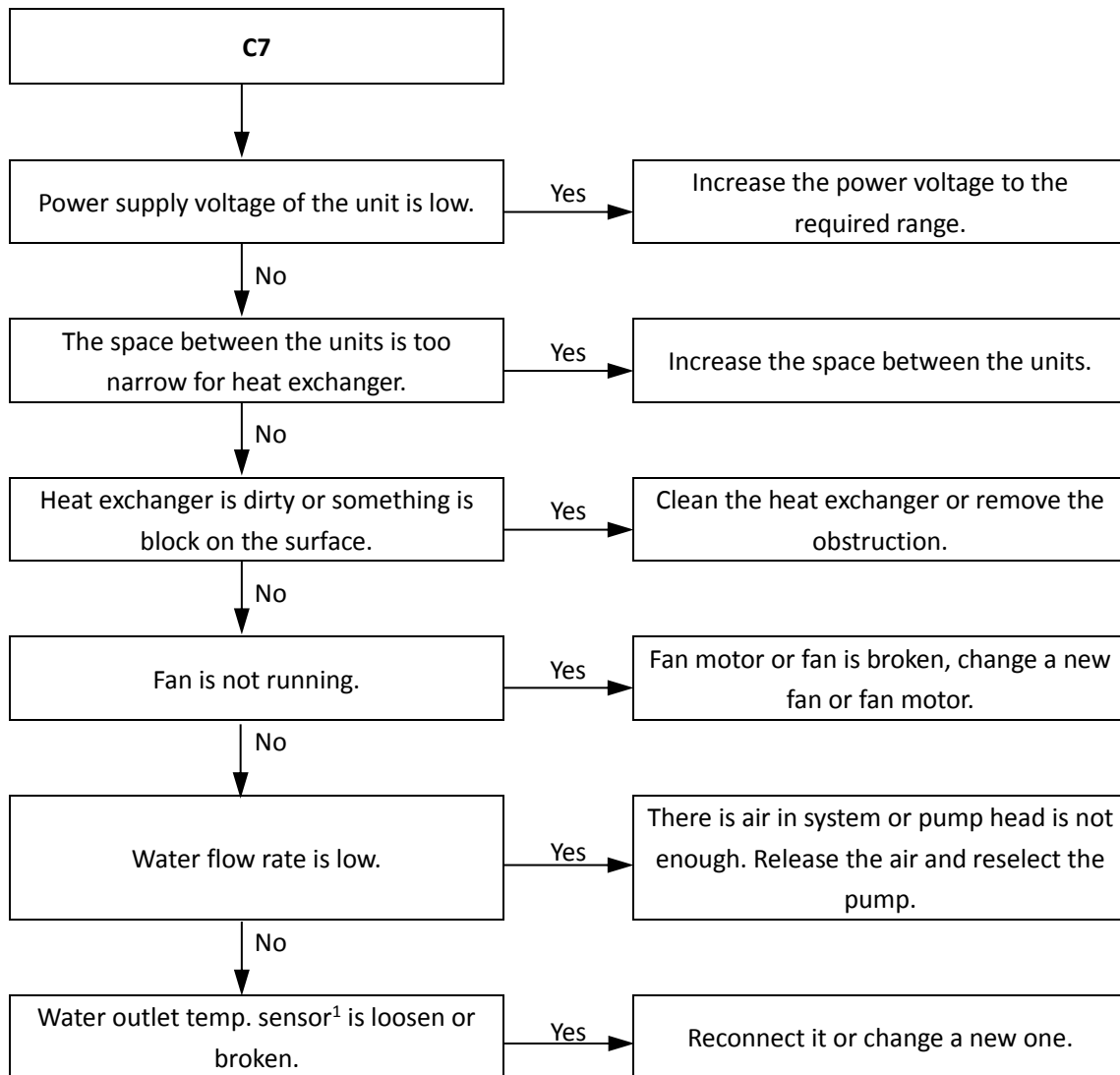

Notes:

1. Water side heat exchanger water inlet temperature sensor and water side heat exchanger water outlet temperature sensor connections are port CN6 on the hydronic system main PCB (labeled 10 in Figure 4-2.1).
2. Set a multi-meter to buzzer mode and test any two terminals of sensor. If the resistance is too low, the buzzer sounds, which means the sensor has short-circuited. If the resistance is not consistent with the sensor's resistance characteristics table, the sensor has failed. Refer to Table 4-5.3.

## 4.24 bH Troubleshooting

### 4.24.1 Digital display output



### 4.24.2 Description

- PED PCB failure
- OPTIMUS PRO Mono stops running.
- Error code is displayed on hydronic system main PCB and user interface.

### 4.24.3 Possible causes

- Power supply problem.
- PED board broken.
- IPM module broken.



## 4.24.4 Procedure

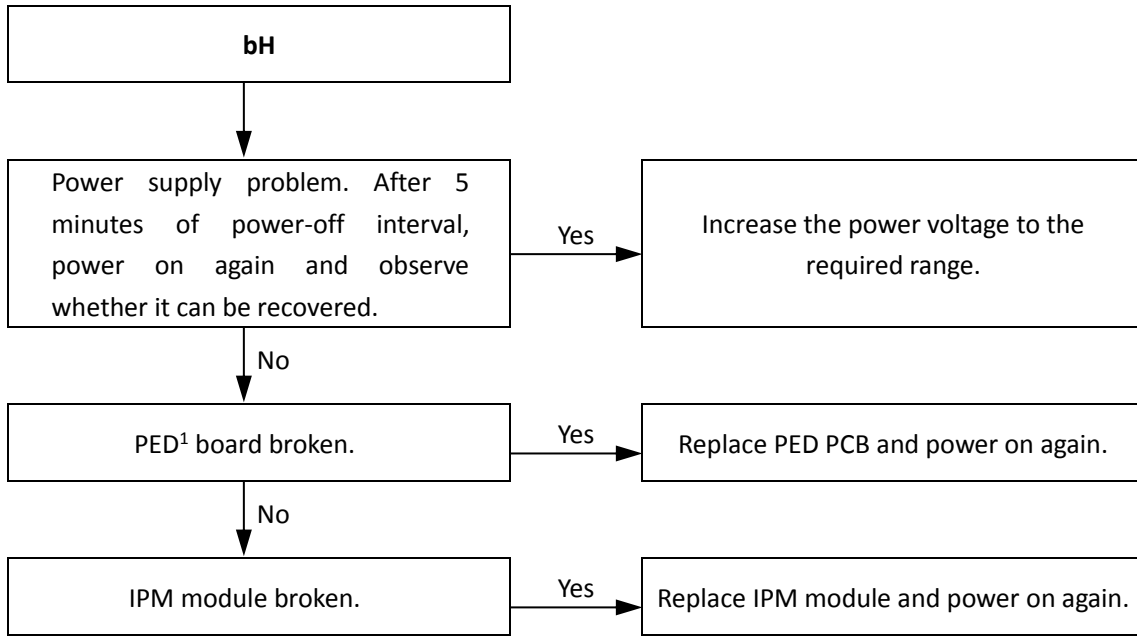

Notes:

1. PED is labeled 13 in Figure 4-2.3.

## 4.25 Pb Troubleshooting

### 4.25.1 Digital display output



### 4.25.2 Description

- Water side heat exchanger anti-freeze protection.
- OPTIMUS PRO Mono stops running.
- Pb is displayed on hydronic system main PCB and **ANTI.FREEZE** icon is displayed on user interface.

### 4.25.3 Possible causes

- Normal system protection.

### 4.25.4 Procedure

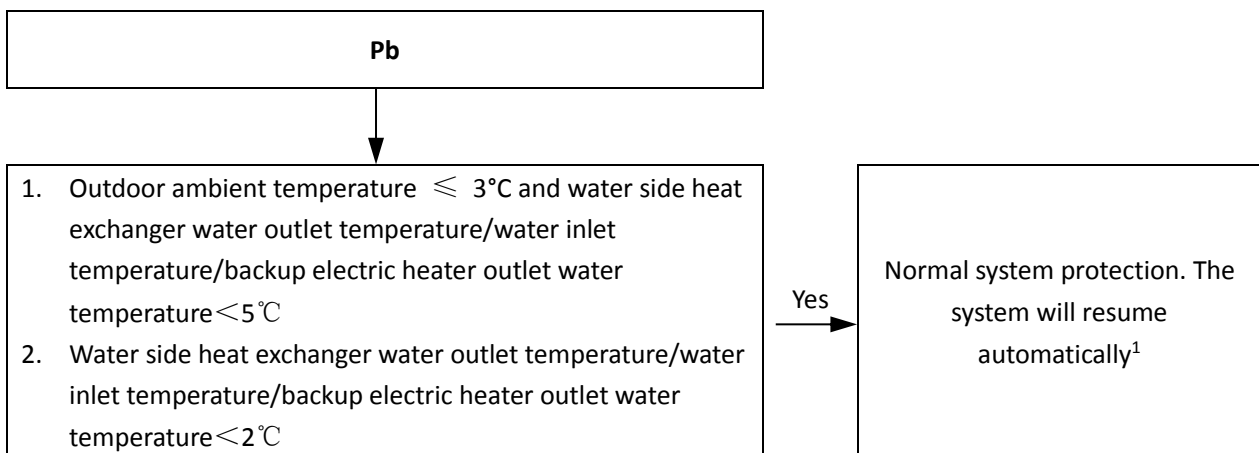

#### Notes:

1. Refer to Part 3, 5.7 "Water Side Heat Exchanger Anti-freeze Protection Control".

# OPTIMUS PRO Mono

## 4.26 HE Troubleshooting

### 4.26.1 Digital display output



### 4.26.2 Description

- Communication error between main control board of hydronic module and Ta/room thermostat transfer PCB
- OPTIMUS PRO Mono stops running.
- Error code is displayed on hydronic system main PCB, outdoor unit main PCB and user interface.

### 4.26.3 Possible causes

- Temperature collecting plate(Optional) connection wire is not connected.
- Temperature collecting plate(Optional) is damaged.

### 4.26.4 Procedure

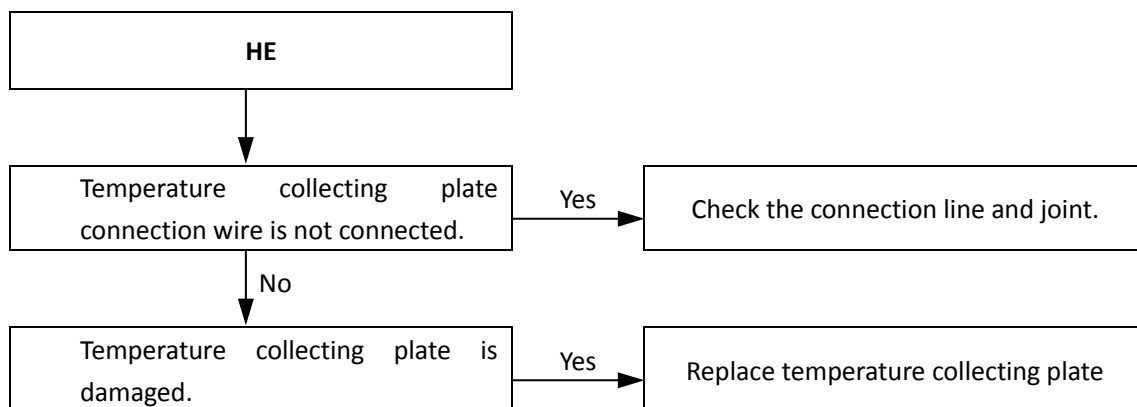

4.27 Hd Troubleshooting

4.27.1 Digital display output



4.27.2 Description

- Communication fault between master unit and slave unit (in parallel)
- OPTIMUS PRO Mono stops running.
- Error code is displayed on hydronic system main PCB, outdoor unit main PCB and user interface.

4.27.3 Possible causes

- SW9 DIP switch with wrong settings
- More than two units are connected to the wire controller
- Power-on interval between master unit and slave unit is longer than 2min
- Wire connection error
- Communication between units is unstable
- Address code missing or address code setting duplicate
- Main board fuse is damaged

4.27.4 Procedure

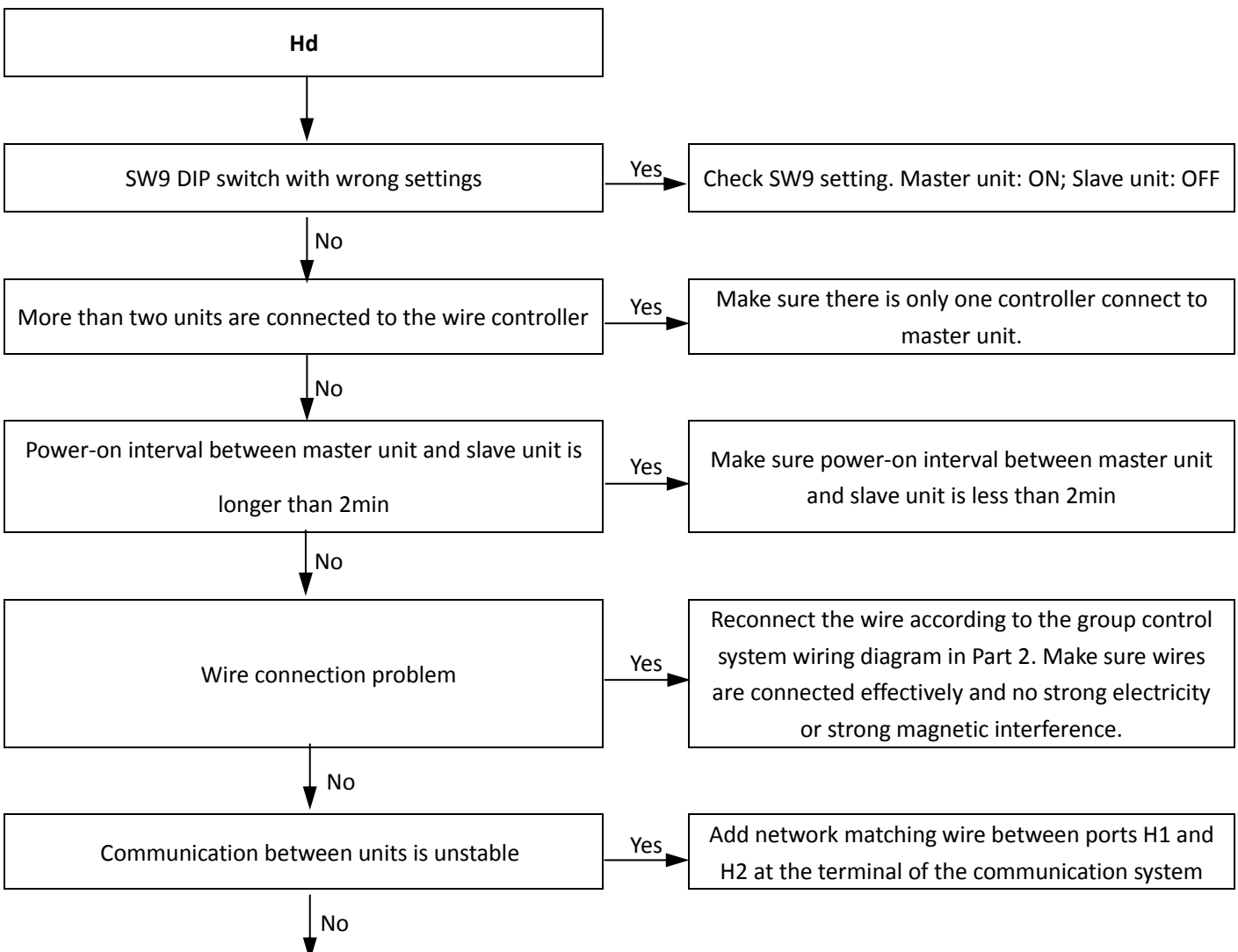

## OPTIMUS PRO Mono

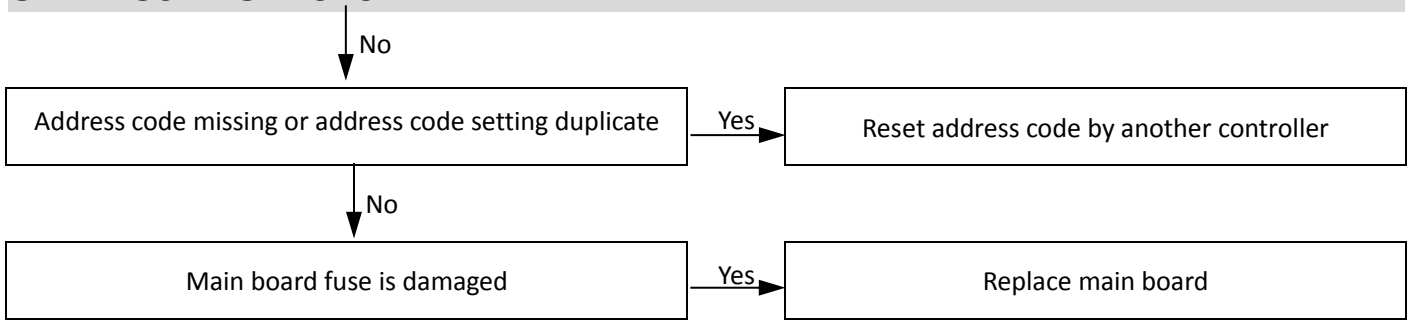

## 5 Appendix to Part 4

### 5.1 Temperature Sensor Resistance Characteristics

Table 4-5.1: Outdoor ambient temperature sensor, water side heat exchanger refrigerant inlet / outlet (liquid / gas pipe) temperature sensor, air side heat exchanger refrigerant out temperature sensor and suction pipe temperature sensor resistance characteristics

Temperature (°C)	Resistance (kΩ)	Temperature (°C)	Resistance (kΩ)	Temperature (°C)	Resistance (kΩ)	Temperature (°C)	Resistance (kΩ)
-25	144.266	15	16.079	55	2.841	95	0.708
-24	135.601	16	15.313	56	2.734	96	0.686
-23	127.507	17	14.588	57	2.632	97	0.666
-22	119.941	18	13.902	58	2.534	98	0.646
-21	112.867	19	13.251	59	2.44	99	0.627
-20	106.732	20	12.635	60	2.35	100	0.609
-19	100.552	21	12.05	61	2.264	101	0.591
-18	94.769	22	11.496	62	2.181	102	0.574
-17	89.353	23	10.971	63	2.102	103	0.558
-16	84.278	24	10.473	64	2.026	104	0.542
-15	79.521	25	10	65	1.953	105	0.527
-14	75.059	26	9.551	66	1.883		
-13	70.873	27	9.125	67	1.816		
-12	66.943	28	8.721	68	1.752		
-11	63.252	29	8.337	69	1.69		
-10	59.784	30	7.972	70	1.631		
-9	56.524	31	7.625	71	1.574		
-8	53.458	32	7.296	72	1.519		
-7	50.575	33	6.982	73	1.466		
-6	47.862	34	6.684	74	1.416		
-5	45.308	35	6.401	75	1.367		
-4	42.903	36	6.131	76	1.321		
-3	40.638	37	5.874	77	1.276		
-2	38.504	38	5.63	78	1.233		
-1	36.492	39	5.397	79	1.191		
0	34.596	40	5.175	80	1.151		
1	32.807	41	4.964	81	1.113		
2	31.12	42	4.763	82	1.076		
3	29.528	43	4.571	83	1.041		
4	28.026	44	4.387	84	1.007		
5	26.608	45	4.213	85	0.974		
6	25.268	46	4.046	86	0.942		
7	24.003	47	3.887	87	0.912		
8	22.808	48	3.735	88	0.883		
9	21.678	49	3.59	89	0.855		
10	20.61	50	3.451	90	0.828		
11	19.601	51	3.318	91	0.802		
12	18.646	52	3.191	92	0.777		
13	17.743	53	3.069	93	0.753		
14	16.888	54	2.952	94	0.73		

# OPTIMUS PRO Mono

Table 4-5.2: Compressor discharge pipe temperature sensor resistance characteristics

Temperature (°C)	Resistance (kΩ)	Temperature (°C)	Resistance (kΩ)	Temperature (°C)	Resistance (kΩ)	Temperature (°C)	Resistance (kΩ)
-20	542.7	20	68.66	60	13.59	100	3.702
-19	511.9	21	65.62	61	13.11	101	3.595
-18	483.0	22	62.73	62	12.65	102	3.492
-17	455.9	23	59.98	63	12.21	103	3.392
-16	430.5	24	57.37	64	11.79	104	3.296
-15	406.7	25	54.89	65	11.38	105	3.203
-14	384.3	26	52.53	66	10.99	106	3.113
-13	363.3	27	50.28	67	10.61	107	3.025
-12	343.6	28	48.14	68	10.25	108	2.941
-11	325.1	29	46.11	69	9.902	109	2.860
-10	307.7	30	44.17	70	9.569	110	2.781
-9	291.3	31	42.33	71	9.248	111	2.704
-8	275.9	32	40.57	72	8.940	112	2.630
-7	261.4	33	38.89	73	8.643	113	2.559
-6	247.8	34	37.30	74	8.358	114	2.489
-5	234.9	35	35.78	75	8.084	115	2.422
-4	222.8	36	34.32	76	7.820	116	2.357
-3	211.4	37	32.94	77	7.566	117	2.294
-2	200.7	38	31.62	78	7.321	118	2.233
-1	190.5	39	30.36	79	7.086	119	2.174
0	180.9	40	29.15	80	6.859	120	2.117
1	171.9	41	28.00	81	6.641	121	2.061
2	163.3	42	26.90	82	6.430	122	2.007
3	155.2	43	25.86	83	6.228	123	1.955
4	147.6	44	24.85	84	6.033	124	1.905
5	140.4	45	23.89	85	5.844	125	1.856
6	133.5	46	22.89	86	5.663	126	1.808
7	127.1	47	22.10	87	5.488	127	1.762
8	121.0	48	21.26	88	5.320	128	1.717
9	115.2	49	20.46	89	5.157	129	1.674
10	109.8	50	19.69	90	5.000	130	1.632
11	104.6	51	18.96	91	4.849		
12	99.69	52	18.26	92	4.703		
13	95.05	53	17.58	93	4.562		
14	90.66	54	16.94	94	4.426		
15	86.49	55	16.32	95	4.294		
16	82.54	56	15.73	96	4.167		
17	78.79	57	15.16	97	4.045		
18	75.24	58	14.62	98	3.927		
19	71.86	59	14.09	99	3.812		

*Table 4-5.3: Water side heat exchanger water inlet / outlet temperature sensor, backup heater exchanger outlet water temperature sensor and DHW temperature sensor resistance characteristics*

Temperature (°C)	Resistance (kΩ)	Temperature (°C)	Resistance (kΩ)	Temperature (°C)	Resistance (kΩ)	Temperature (°C)	Resistance (kΩ)
-30	853.724	10	98.227	50	17.600	90	4.4381
-29	802.986	11	93.634	51	16.943	91	4.3022
-28	755.557	12	89.278	52	16.315	92	4.1711
-27	711.21	13	85.146	53	15.713	93	4.0446
-26	669.728	14	81.225	54	15.136	94	3.9225
-25	630.913	15	77.504	55	14.583	95	3.8046
-24	594.58	16	73.972	56	14.054	96	3.6908
-23	560.556	17	70.619	57	13.546	97	3.5810
-22	528.68	18	67.434	58	13.059	98	3.4748
-21	498.814	19	64.409	59	12.592	99	3.3724
-20	470.812	20	61.535	60	12.144	100	3.2734
-19	444.548	21	58.804	61	11.715	101	3.1777
-18	419.907	22	56.209	62	11.302	102	3.0853
-17	396.779	23	53.742	63	10.906	103	2.9960
-16	375.063	24	51.396	64	10.526	104	2.9096
-15	354.662	25	49.165	65	10.161	105	2.8262
-14	335.492	26	47.043	66	9.8105		
-13	317.470	27	45.025	67	9.4736		
-12	300.521	28	43.104	68	9.1498		
-11	284.576	29	41.276	69	8.8387		
-10	269.569	30	39.535	70	8.5396		
-9	255.439	31	37.878	71	8.2520		
-8	242.131	32	36.299	72	7.9755		
-7	229.593	33	34.796	73	7.7094		
-6	217.774	34	33.363	74	7.4536		
-5	206.630	35	31.977	75	7.2073		
-4	196.119	36	30.695	76	6.9704		
-3	186.201	37	29.453	77	6.7423		
-2	176.840	38	28.269	78	6.5228		
-1	168.001	39	27.139	79	6.3114		
0	159.653	40	26.061	80	6.1078		
1	151.766	41	25.031	81	5.9117		
2	144.311	42	24.048	82	5.7228		
3	137.264	43	23.109	83	5.5409		
4	130.599	44	22.212	84	5.3655		
5	124.293	45	21.355	85	5.1965		
6	118.326	46	20.536	86	5.0336		
7	112.679	47	19.752	87	4.8765		
8	107.330	48	19.003	88	4.7251		
9	102.265	49	18.286	89	4.5790		



