

# Service Manual

## OPTIMUS PRO Mono (4~16kW)



# CONTENTS

Part 1 General Information.....	3
Part 2 Component Layout and Refrigerant Circuits .....	5
Part 3 Control .....	15
Part 4 Diagnosis and Troubleshooting.....	31



# Part 1

# General Information

1 Unit Capacities and External Appearance ..... 4



# OPTIMUS PRO Mono

## 1 Unit Capacities and External Appearance

### 1.1 Unit Capacities

Table 1-1.1: Capacity range

Capacity	4kW	6kW	8kW	10kW	12kW	14kW	16kW
Model <sup>1</sup> (HOP**WMONO <sup>2</sup> )	V4W	V6W	V8W	V10W	V12W	V14W	V16W

Capacity	12kW	14kW	16kW
Model <sup>1</sup> (HOP**WMONO3 <sup>2</sup> )	V12W	V14W	V16W

Notes:

1. The full model names can be obtained by substituting the asterisk in the model name format given in the left-hand column of the table above with the shortened model names given in the table. For example, the model name for the 8kW model is HOP8WMONO.
2. The presence or omission of the letter R in the model names indicates the unit's power supply:
  - R: 3-phase, 380-415V, 50Hz; Omitted: 1-phase, 220-240V, 50Hz.

### 1.2 External Appearance

Table 1-1.2: Unit appearance

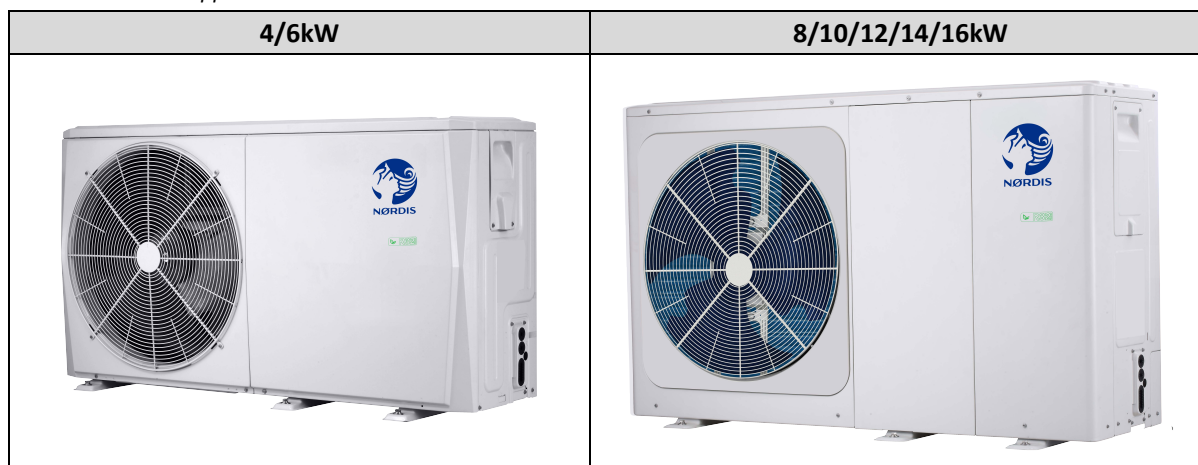

# Part 2

# Component Layout and Refrigerant Circuits

1 Layout of Functional Components.....	6
2 Piping Diagrams .....	11
3 Refrigerant Flow Diagrams .....	13

# OPTIMUS PRO Mono

## 1 Layout of Functional Components

### HOP4WMONO / HOP6WMONO

Figure 2-1.1: HOP4(6)WMONO top view

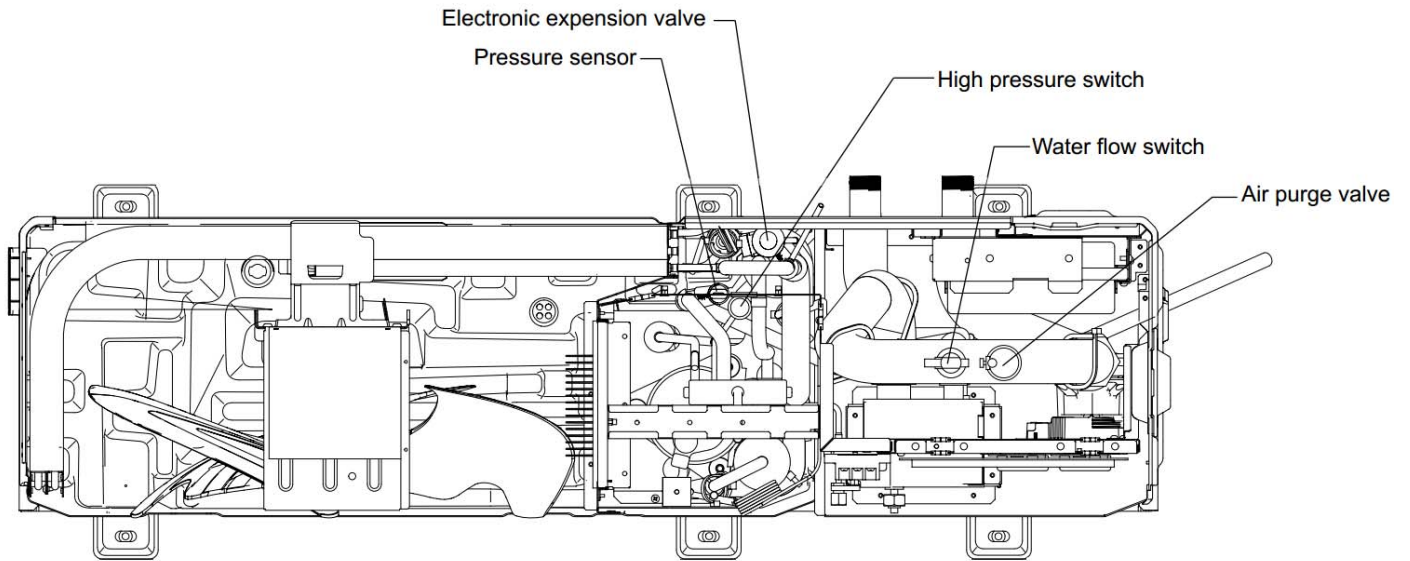

Figure 2-1.2: HOP4(6)WMONO front view

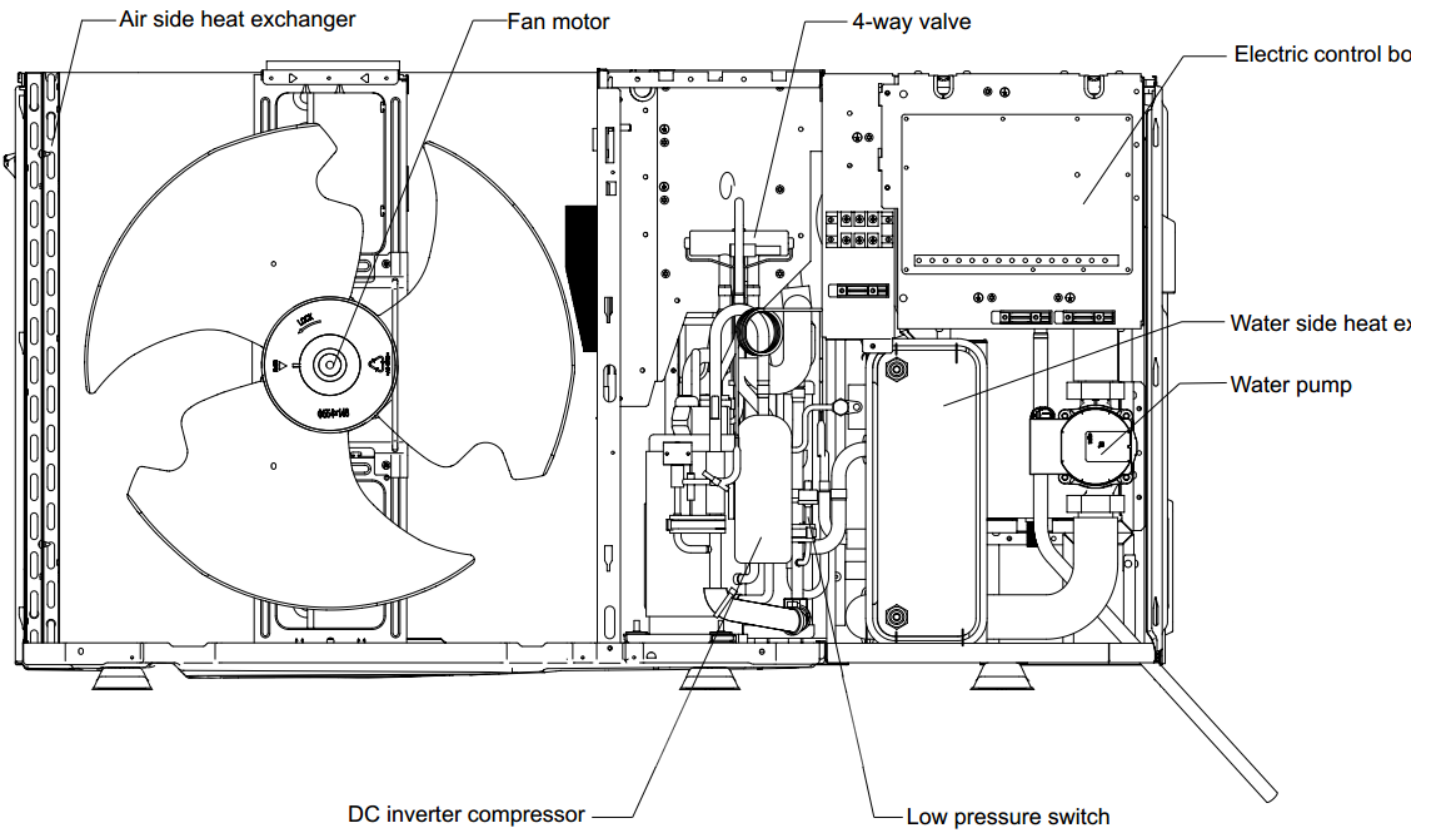
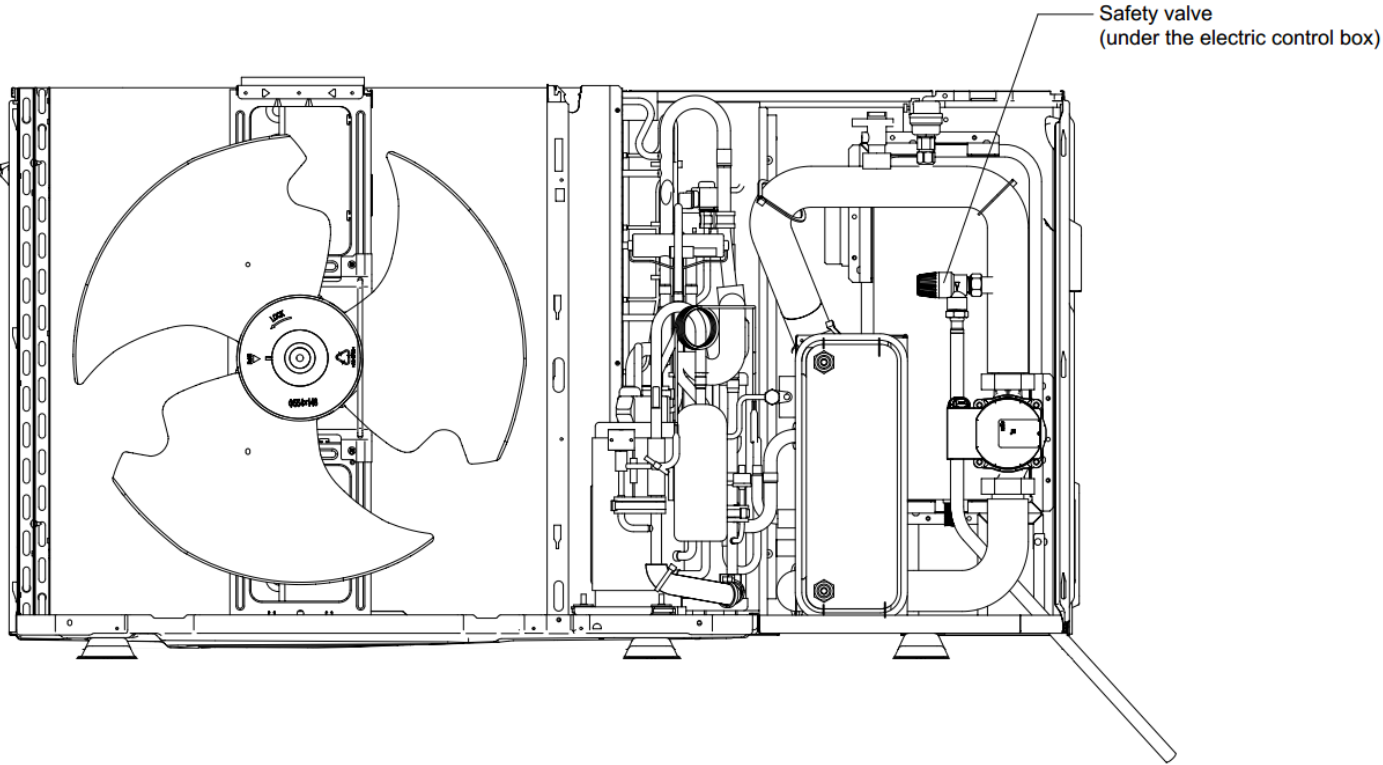
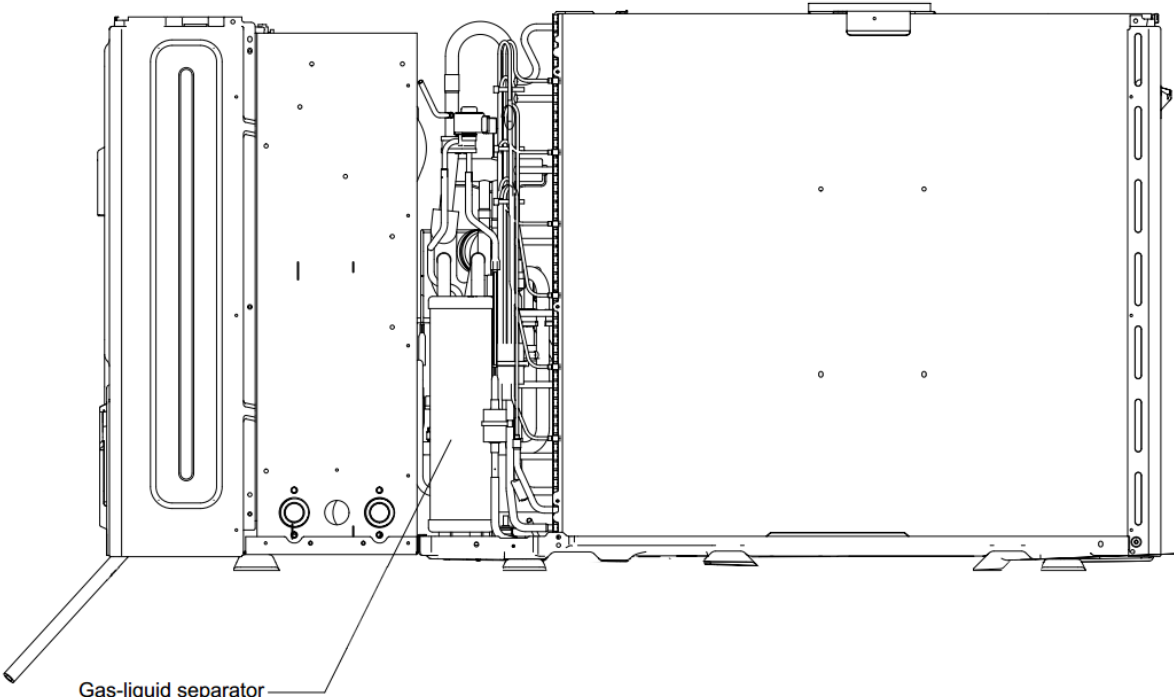

Figure 2-1.3: HOP4(6)WMONO



# OPTIMUS PRO Mono

## HOP8WMONO / HOP10WMONO

Figure 2-1.1: HOP8(10)WMONO top view

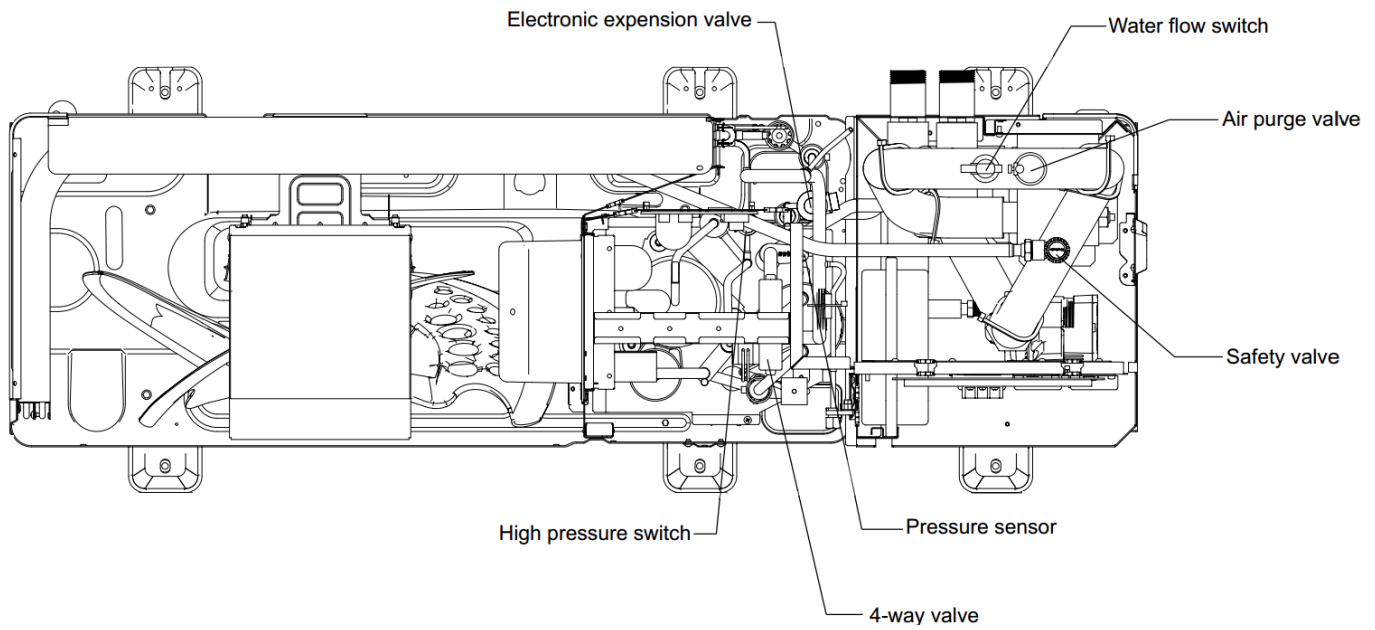
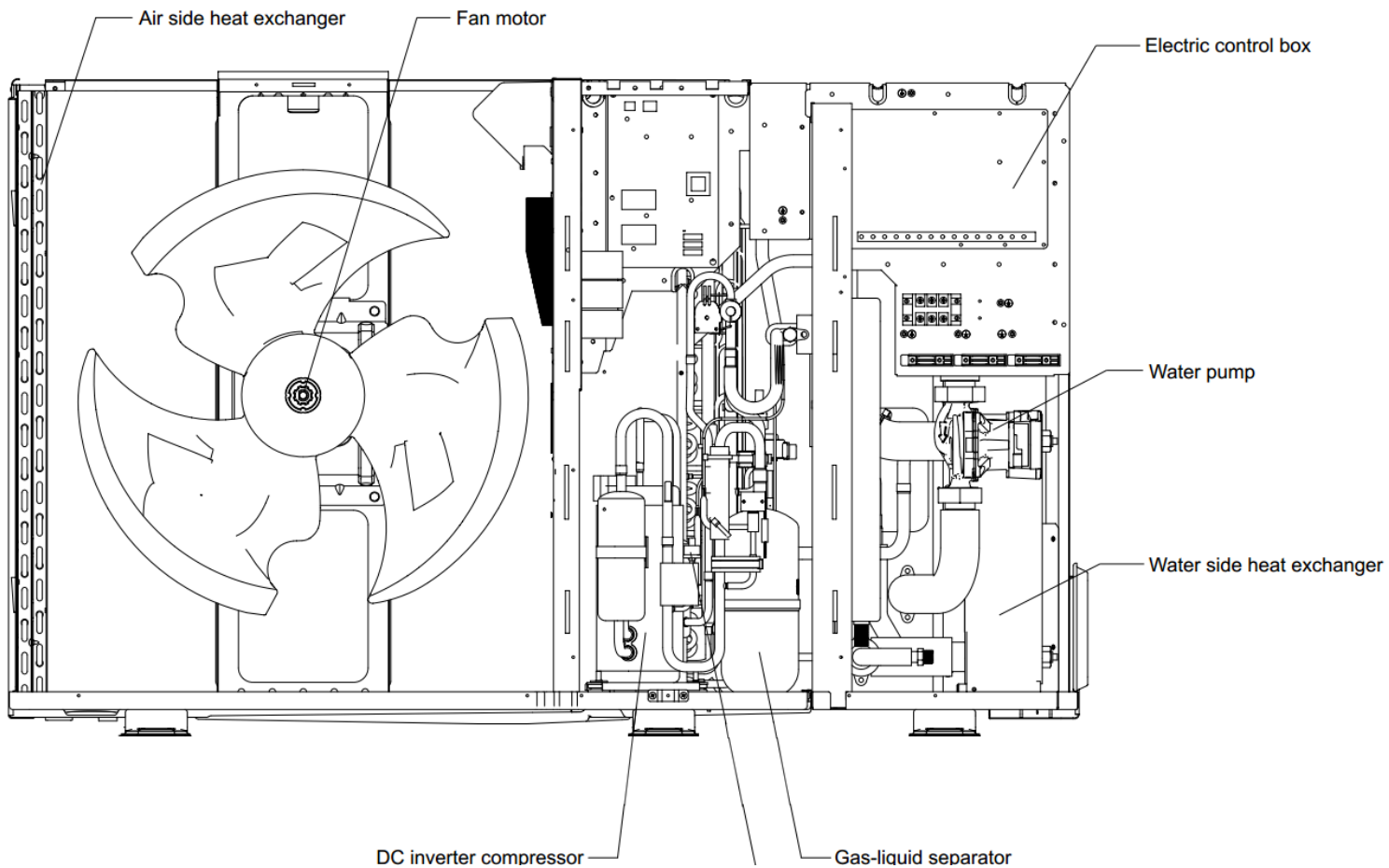

Figure 2-1.2: HOP8(10)WMONO front view



HOP12WMONO / HOP14WMONO / HOP16WMONO

Figure 2-1.4: HOP12(14,16)WMONO top view

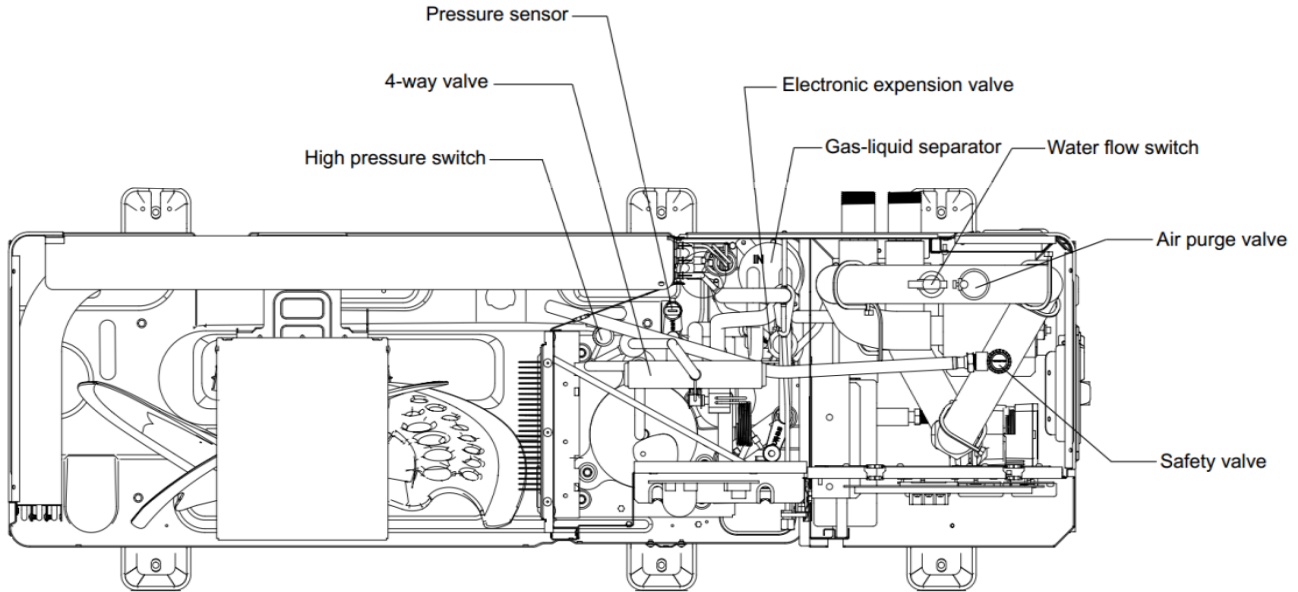
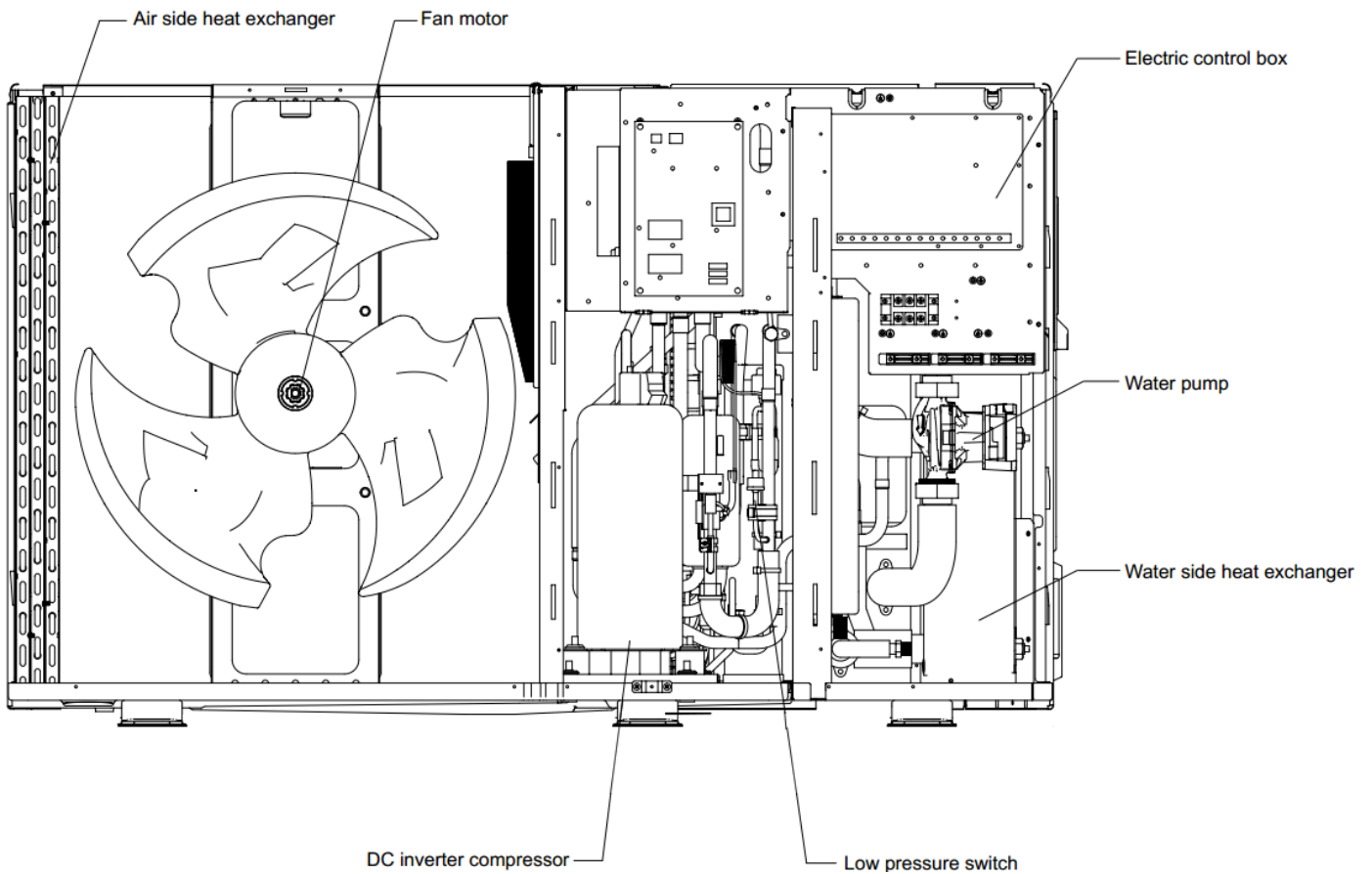

Figure 2-1.5: HOP12(14,16)WMONO, HOP12(14,16)WMONO3 front view



# OPTIMUS PRO Mono

## HOP12WMONO3 / HOP14WMONO3 / HOP16WMONO3

Figure 2-1.4: HOP12(14,16)WMONO3 top view

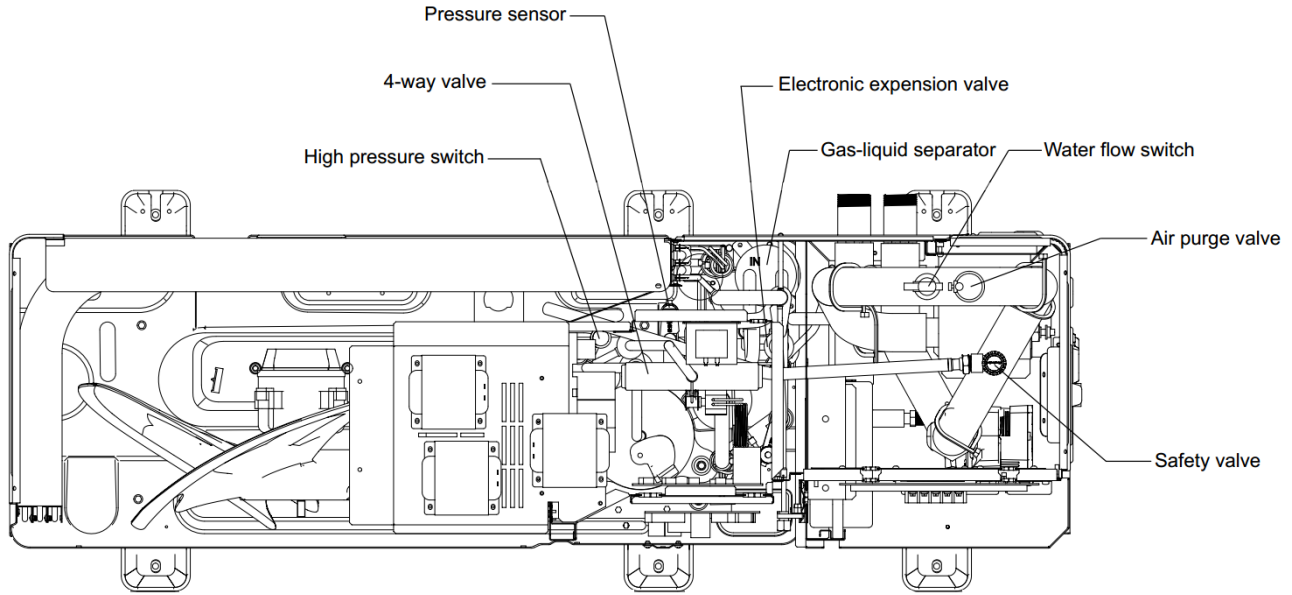
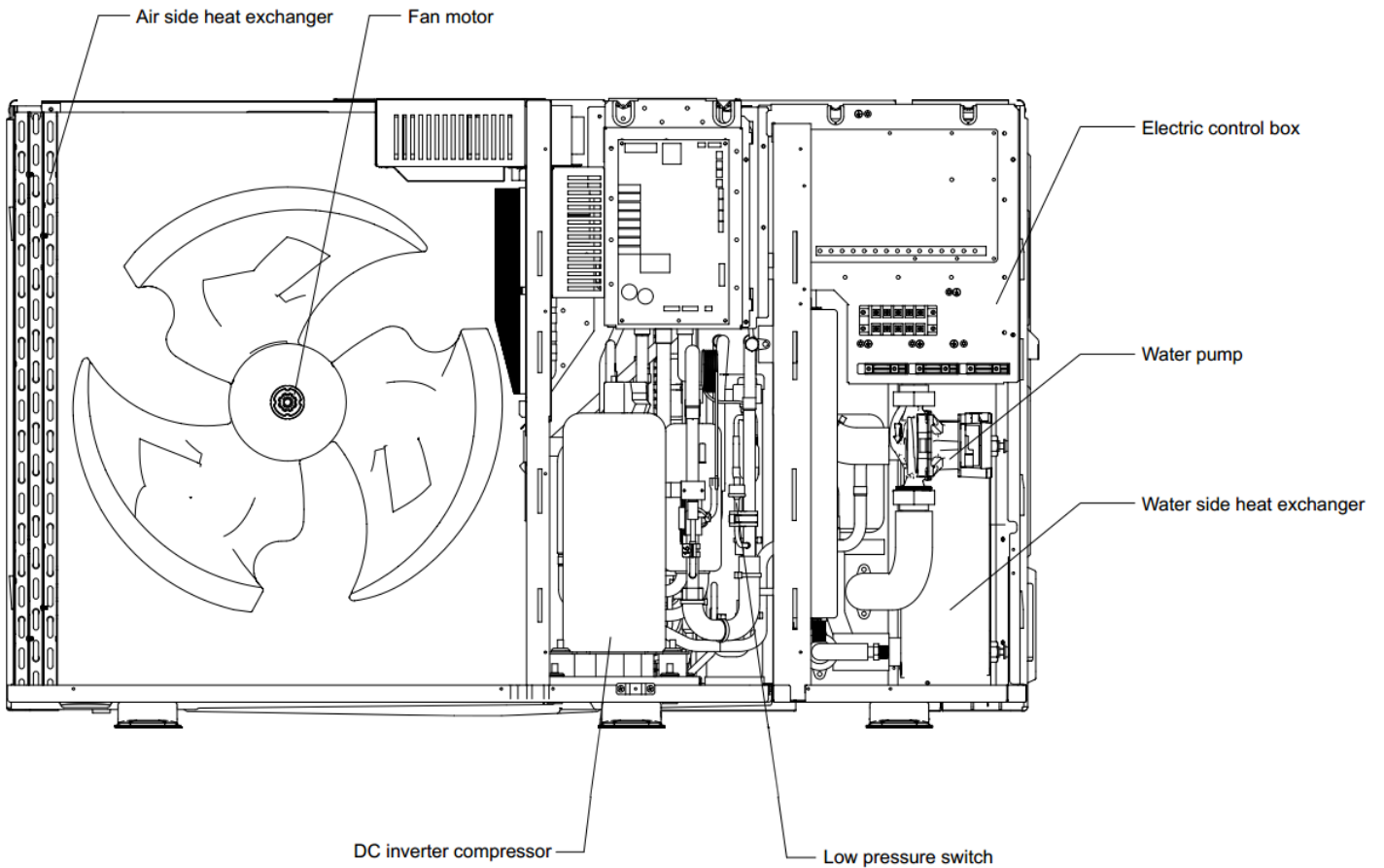
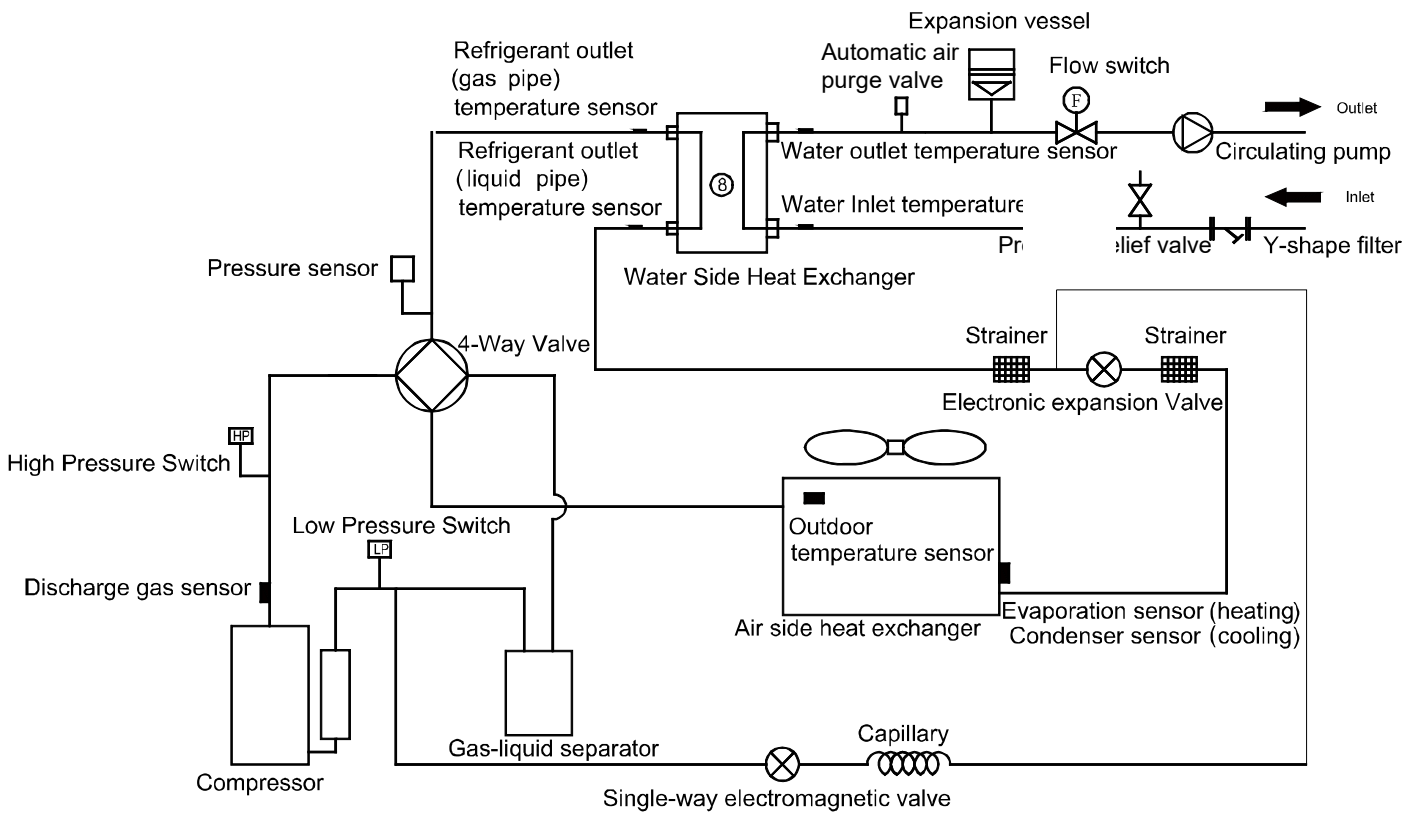

Figure 2-1.5: HOP12(14,16)WMONO, HOP12(14,16)WMONO3 front view



## 2 Piping Diagrams

Figure 2-2.1: Piping diagram





## OPTIMUS PRO Mono

### Key components:

1. **Accumulator:**  
Stores liquid refrigerant and oil to protect compressor from liquid hammering.
2. **Electronic expansion valve (EXV):**  
Controls refrigerant flow and reduces refrigerant pressure.
3. **Four-way valve:**  
Controls refrigerant flow direction. Closed in cooling mode and open in heating mode. When closed, the air side heat exchanger functions as a condenser and water side heat exchanger functions as an evaporator; when open, the air side heat exchanger functions as an evaporator and water side heat exchanger function as a condenser.
4. **High and low pressure switches:**  
Regulate refrigerant system pressure. When refrigerant system pressure rises above the upper limit or falls below the lower limit, the high or low pressure switches turn off, stopping the compressor.
5. **Air purge valve:**  
Automatically removes air from the water circuit.
6. **Safety valve:**  
Prevents excessive water pressure by opening at 43.5 psi (3 bar) and discharging water from the water circuit.
7. **Expansion vessel:**  
Balances water system pressure. (Expansion vessel volume: 8L)
8. **Water flow switch:**  
Detects water flow rate to protect compressor and water pump in the event of insufficient water flow.
9. **Backup heater:**  
Provides additional heating capacity when the heating capacity of the heat pump is insufficient due to very low outdoor temperature. Also protects the external water piping from freezing.
10. **Water pump:**  
Circulates water in the water circuit.

### 3 Refrigerant Flow Diagrams

#### Heating and domestic hot water operation

Figure 2-3.1: Refrigerant flow during heating or domestic hot water operation

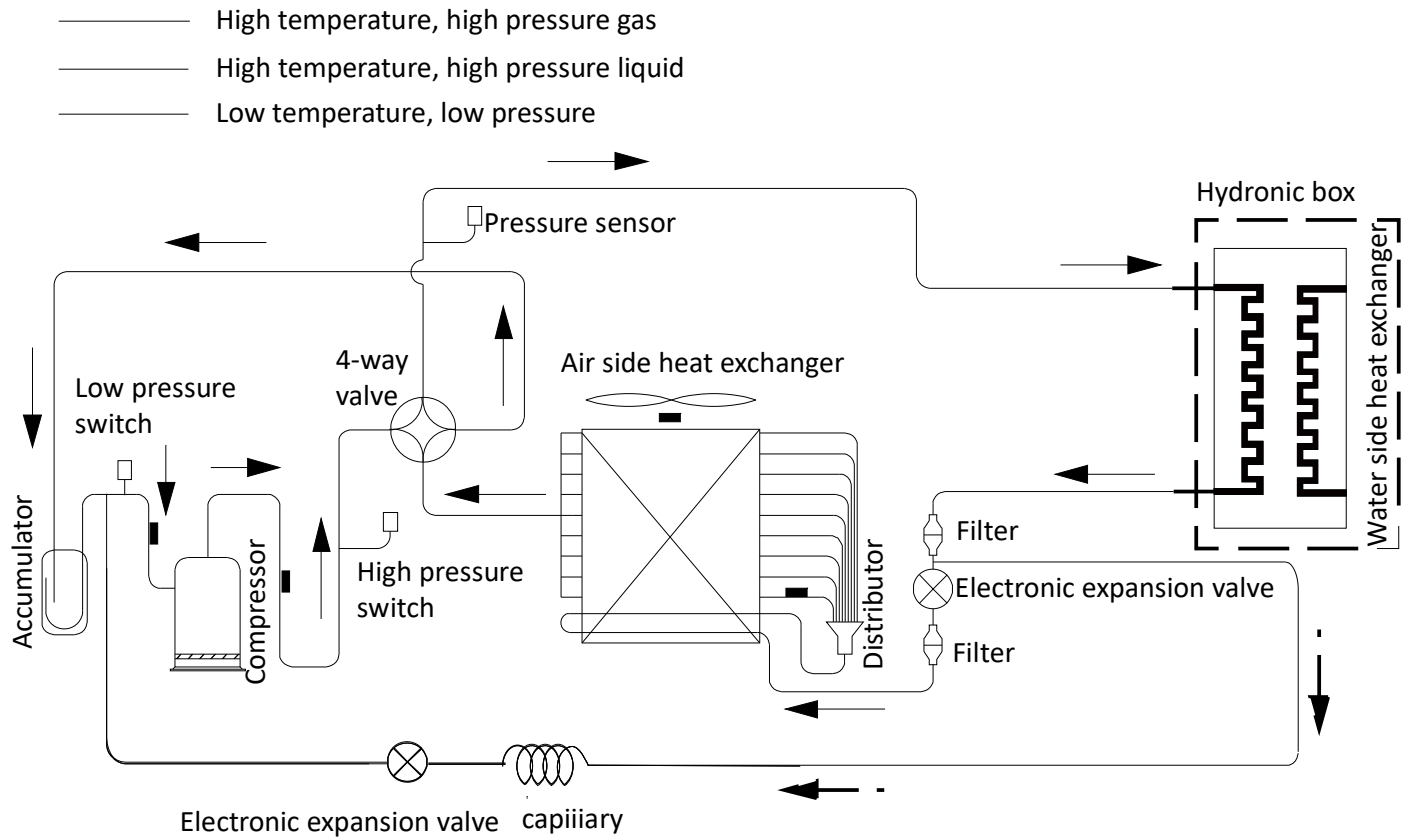

#### Cooling and defrosting operation

Figure 2-3.2: Refrigerant flow during cooling and defrosting operations

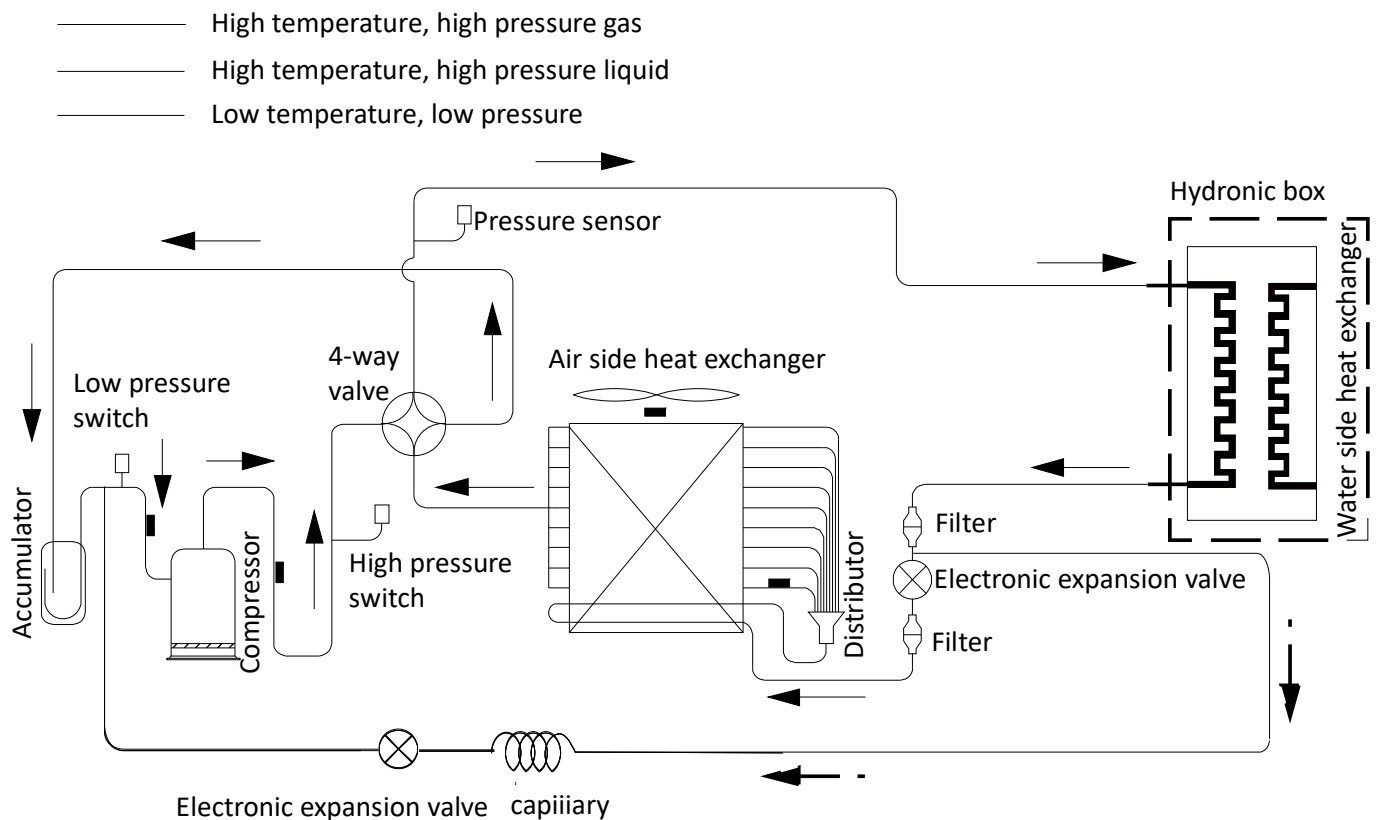



# Part 3

# Control

<b>1 Stop Operation .....</b>	<b>16</b>
<b>2 Standby Control .....</b>	<b>16</b>
<b>3 Startup Control .....</b>	<b>17</b>
<b>4 Normal Operation Control .....</b>	<b>19</b>
<b>5 Protection Control .....</b>	<b>21</b>
<b>6 Special Control.....</b>	<b>25</b>
<b>7 Role of Temperature Sensors in Control Functions .....</b>	<b>28</b>

## 1 Stop Operation

The stop operation occurs for one of the following reasons:

1. Abnormal shutdown: in order to protect the compressors, if an abnormal state occurs the system makes a 'stop with thermo off' operation and an error code is displayed on the outdoor unit PCB digital displays and on the user interface.
2. The system stops when the set temperature has been reached.

## 2 Standby Control

### 2.1 Crankcase Heater Control

The crankcase heater is used to prevent refrigerant from mixing with compressor oil when the compressors are stopped. The crankcase heater is controlled according to outdoor ambient temperature and the compressor on/off state. When the outdoor ambient temperature is above 8°C or the compressor is running, the crankcase heater is off; when the outdoor ambient temperature is at or below 8°C and either the compressor has been stopped for more than 3 hours or the unit has just been powered-on (either manually or when the power has returned following a power outage), the crankcase heater turns on.

### 2.2 Water Pump Control

When the outdoor unit is in standby, the internal and external circulator pumps run continuously.

### 3 Startup Control

#### 3.1 Compressor Startup Delay Control

In initial startup control and in restart control (except in oil return operation and defrosting operation), compressor startup is delayed such that a minimum of the set re-start delay time has elapsed since the compressor stopped, in order to prevent frequent compressor on/off and to equalize the pressure within the refrigerant system. The compressor re-start delays for cooling and heating modes are set on the user interface. Refer to the OPTIMUS PRO Mono Engineering Data Book Part 3, 7.5 "COOL MODE SETTING Menu" and Part 3, 7.6 "HEAT MODE SETTING Menu".

#### 3.2 Compressor Startup Program

In initial startup control and in re-start control, compressor startup is controlled according to outdoor ambient temperature. Compressor startup follows one of two startup programs until the target rotation speed is reached. Refer to Figures 3-3.1, 3-3.2, 3-3.3 and 3-3.4.

Figure 3-3.1: 4-6kW to 12-16kW Compressor startup program<sup>1,2</sup> when ambient temperature is above 3°C

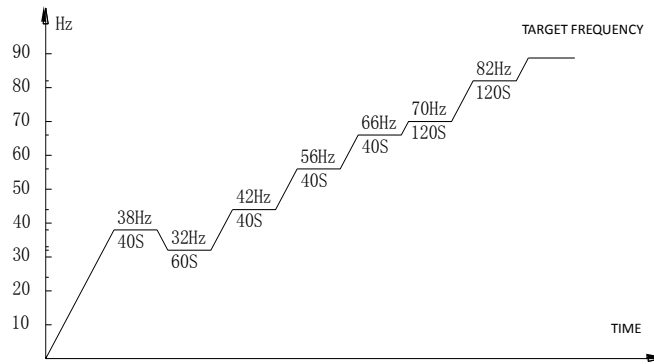
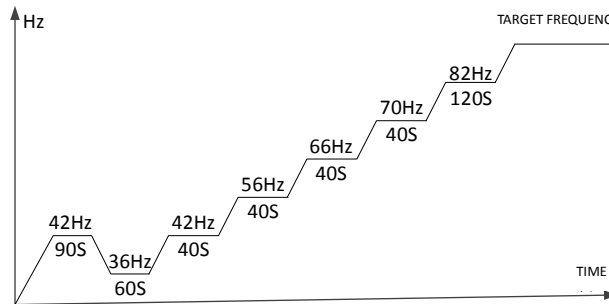

Figure 3-3.2: 8-10kW Compressor startup program<sup>1,2</sup> when ambient temperature is above 11°C



# OPTIMUS PRO Mono

Figure 3-3.3: 4-10KW compressor startup program<sup>1</sup> when ambient temperature is at or below 3°C (4-6KW)/11°C(8-10KW)

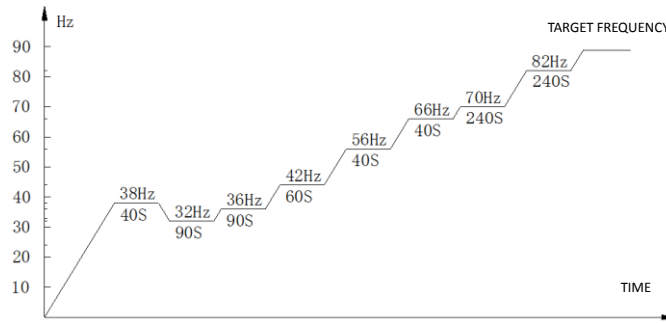
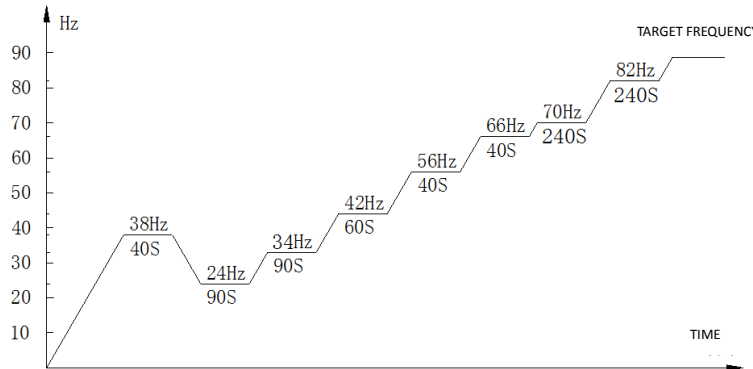

Figure 3-3.4: 12-16KW compressor startup program<sup>1</sup> when ambient temperature is at or below 3°C



Notes:

- Once the first, 40-second stage of the program is complete, the program proceeds to the subsequent stages in a step-by-step fashion and exits when the target rotation speed has been reached.

## 3.3 Startup Control for Heating and Domestic Hot Water Operation

Table 3-3.1: Component control during startup in heating and domestic hot water modes

Component	Wiring diagram label	4/6kW	8/10/12/14/16kW	Control functions and states
Inverter compressor	COMP	•	•	Compressor startup program selected according to ambient temperature <sup>1</sup>
DC fan motor	FAN	•	•	Fan runs at maximum speed <sup>2</sup>
Electronic expansion valve	EXV	•	•	Position (steps) from 0 (fully closed) to 480 (fully open), controlled according to outdoor ambient temperature, discharge temperature and suction superheat
Four-way valve	ST	•	•	On

## 3.4 Startup Control for Cooling Operation

Table 3-3.2: Component control during startup in cooling mode

Component	Wiring diagram label	4/6kW	8/10/12/14/16kW	Control functions and states
Inverter compressor	COMP	•	•	Compressor startup program selected according to ambient temperature <sup>1</sup>
DC fan motor	FAN	•	•	Fan run at maximum speed <sup>2</sup>
Electronic expansion valve	EXV	•	•	Position (steps) from 0 (fully closed) to 480 (fully open), controlled according to outdoor ambient temperature, discharge temperature and suction superheat
Four-way valve	ST	•	•	Off

Notes:

- Refer to Figure 3-3.1, Figure 3-3.2, Figure 3-3.3 and Figure 3-3.4 in Part 3, 4.2 "Compressor Startup Program".
- Refer to Table 3-4.3 in Part 3, 5.6 "Outdoor Fan Control".

## 4 Normal Operation Control

### 4.1 Component Control during Normal Operation

Table 3-4.1: Component control during heating and domestic hot water operations

Component	Wiring diagram label	4/6kW	8/10/12/14/16kW	Control functions and states
Inverter compressor	COMP	•	•	Controlled according to load requirement from hydronic system
DC fan motor	FAN	•	•	Controlled according to outdoor heat exchanger pipe temperature
Electronic expansion valve	EXV	•	•	Position (steps) from 0 (fully closed) to 480 (fully open), controlled according to discharge temperature, suction superheat and compressor speed
Four-way valve	ST	•	•	On

Table 3-4.2: Component control during cooling operation

Component	Wiring diagram label	4/6kW	8/10/12/14/16kW	Control functions and states
Inverter compressor	COMP	•	•	Controlled according to load requirement from hydronic system
DC fan motor	FAN	•	•	Controlled according to outdoor heat exchanger pipe temperature
Electronic expansion valve	EXV	•	•	Position (steps) from 0 (fully closed) to 480 (fully open), controlled according to discharge temperature, suction superheat and compressor speed
Four-way valve	ST	•	•	Off

### 4.2 Compressor Output Control

The compressor rotation speed is controlled according to the load requirement. Before compressor startup, the OPTIMUS PRO Mono outdoor unit determines the compressor target speed according to outdoor ambient temperature, leaving water set temperature and actual leaving water temperature and then runs the appropriate compressor startup program. Refer to Part 3, 4.2 “Compressor Startup Program”. Once the startup program is complete, the compressor runs at the target rotation speed.

During operation the compressor speed is controlled according to the rate of change in water temperature, the refrigerant system pressure and the refrigerant temperature.

### 4.3 Compressor Step Control

The running speed of six-pole compressors (used on all models) in rotations per second (rps) is one third of the frequency (in Hz) of the electrical input to the compressor motor. The frequency of the electrical input to the compressor motors can be altered at a rate of 1Hz per second.



# OPTIMUS PRO Mono

## 4.4 Four-way Valve Control

The four-way valve is used to change the direction of refrigerant flow through the water side heat exchanger in order to switch between cooling and heating/DHW operations.

During heating and DHW operations, the four-way valve is on; during cooling and defrosting operations, the four-way valve is off.

## 4.5 Electronic Expansion Valve Control

The position of the electronic expansion valve (EXV) is controlled in steps from 0 (fully closed) to 480 (fully open).

- At power-on:
  - The EXV first closes fully, then moves to the standby position. After a few seconds the EXV moves to an initial running position, which is determined according to operating mode and outdoor ambient temperature. After a further few minutes, the EXV is controlled according to suction superheat and discharge temperature. Once a further few minutes have elapsed, the EXV is then controlled according to suction superheat, discharge temperature and compressor speed.
- When the outdoor unit is in standby:
  - The EXV is at standby position.
- When the outdoor unit stops:
  - The EXV first closes fully, then moves to the standby position.

## 4.6 Outdoor Fan Control

The speed of the outdoor unit fan(s) is adjusted in steps, as shown in Table 3-4.3.

Table 3-4.3: Outdoor fan speed steps

Fan speed index	Fan speed (rpm)			
	4-6kW	8-10kW	12-14kW	16kW
0	0	0	0	0
1	200	200	200	200
2	250	250	250	250
3	300	300	300	300
4	350	350	350	350
5	400	400	400	400
6	450	450	450	450
7	500	500	500	500
8	530	530	550	550
9	550	550	580	600
10	580	580	610	650
11	600	600	630	700
12	600	600	650	730

## 4.7 Spray liquid cooling control

When the discharge temperature of compressor exceeds  $105^{\circ}\text{C}$ , the solenoid valve opens and the frequency of compressor drops in order to reduce the discharge temperature. When the discharge temperature is below  $100^{\circ}\text{C}$ , the solenoid valve closes.

If the discharge temperature exceeds  $108^{\circ}\text{C}$  while the spray liquid cooling control is in progress, which is judged every 20s, the frequency of compressor drops 4Hz until the minimum frequency which differs from every model. When the discharge temperature is below  $101^{\circ}\text{C}$ , the compressor runs at the current frequency.

## 5 Protection Control

### 5.1 High Pressure Protection Control

This control protects the refrigerant system from abnormally high pressure and protects the compressor from transient spikes in pressure.

Figure 3-5.1: High pressure protection control

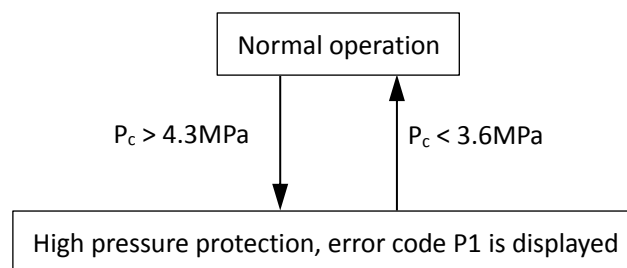

Notes:

1.  $P_c$ : Discharge pressure

When the discharge pressure rises above 4.3MPa the system displays P1 protection and the unit stops running. When the discharge pressure drops below 3.6MPa, the compressor enters re-start control.

### 5.2 Low Pressure Protection Control

This control protects the refrigerant system from abnormally low pressure and protects the compressor from transient drops in pressure.

Figure 3-5.2: Low pressure protection control

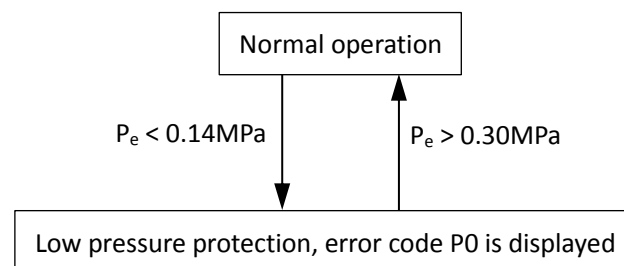

Notes:

1.  $P_e$ : Suction pressure

When the suction pressure drops below 0.14MPa the system displays P0 protection and the unit stops running. When the suction pressure rises above 0.3MPa, the compressor enters re-start control.

# OPTIMUS PRO Mono

## 5.3 Discharge Temperature Protection Control

This control protects the compressor from abnormally high temperatures and transient spikes in temperature.

Figure 3-5.3: High discharge temperature protection control

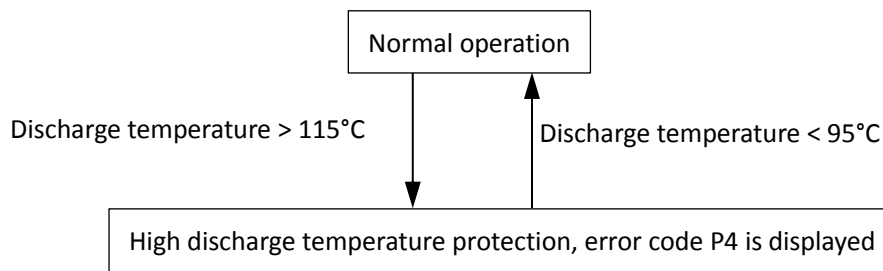

When the discharge temperature rises above 115°C the system displays P4 protection and the unit stops running. When the discharge temperature drops below 95°C, the compressor enters re-start control.

Figure 3-5.4: Low discharge temperature protection control

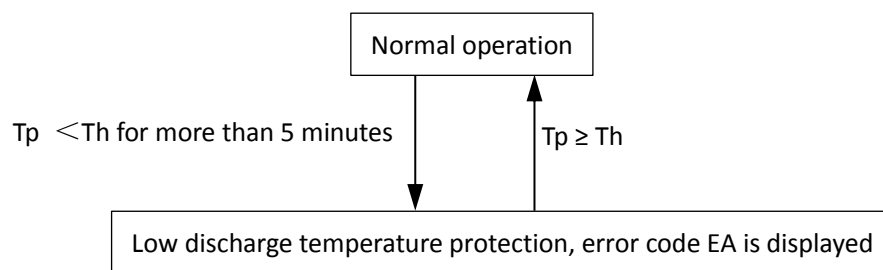

When the discharge temperature is lower than suction temperature for more than 5 minutes, the system displays EA protection and the unit stops running. When the discharge temperature is higher than suction temperature, the compressor enters re-start control.

## 5.4 Compressor Current Protection Control

This control protects the compressor from abnormally high currents.

Figure 3-5.5: Compressor current protection control

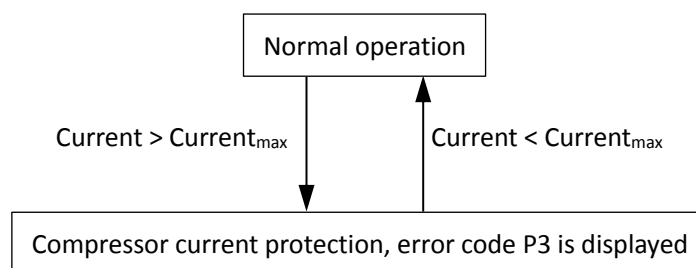

Table 3-5.1: Current limitation for compressors

Model name	4-6kw	8-10kw	12-16kw 1ph	12-16kw 3ph
Current <sub>max</sub>	18A	19A	30A	14A

When the compressor current rises above Current<sub>max</sub> the system displays P3 protection and the unit stops running. When the compressor current drops below Current<sub>max</sub>, the compressor enters re-start control.

## 5.5 Voltage Protection Control

This control protects the OPTIMUS PRO Mono from abnormally high or abnormally low voltages.

Figure 3-5.4: Compressor voltage protection control

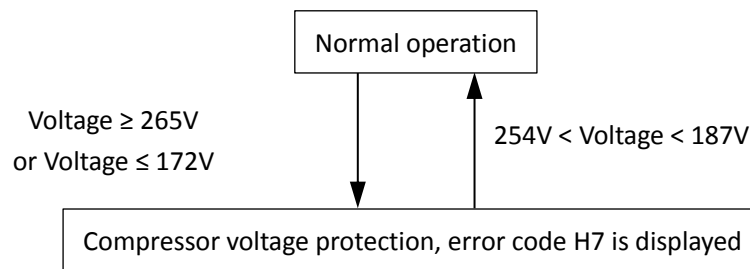

When the phase voltage of AC power supply is at or above 265V for more than 30 seconds, the system displays H7 protection and the unit stops running. When the phase voltage drops below 265V for more than 30 seconds, the refrigerant system restarts once the compressor re-start delay has elapsed. When the phase voltage is at or below 172V, the system displays H7 protection and the unit stops running. When the AC voltage rises to at or more than 187V, the refrigerant system restarts once the compressor re-start delay has elapsed.

## 5.6 DC Fan Motor Protection Control

This control protects the DC fan motors from strong winds and abnormal power supply. DC fan motor protection occurs when any one of the following three sets of conditions are met:

- Outdoor ambient temperature is at or above 4°C and actual fan speed differs from target fan speed by more than 200rpm for more than 3 minutes.
- Outdoor ambient temperature is below 4°C and actual fan speed differs from target fan speed by more than 300rpm for more than 3 minutes.
- Actual fan speed is less than 150rpm for more than 90 seconds.

When DC fan motor protection control occurs the system displays the H6 error code and the unit stops running. After 3 minutes, the unit restarts automatically. When H6 protection occurs 10 times in 120 minutes, the HH error is displayed. When an HH error occurs, a manual system restart is required before the system can resume operation.

## 5.7 Water Side Heat Exchanger Anti-freeze Protection Control

This control protects the water side heat exchanger from ice formation.

In cooling mode, if inlet water temperature or leaving water temperature or auxiliary heat source leaving water temperature is below 4°C, heat pump stops and water pump keeps running for 30min. If water temperature is still below 4°C, heat pump turns to heating mode.

In heating/DHW standby mode, if ambient temperature is below 3°C and inlet water temperature or leaving water temperature or auxiliary heat source leaving water temperature is below 5°C, heat pump stops and water pump keeps running for 30min. If ambient temperature is still below 3°C and water temperature is still below 5°C, heat pump turns to heating mode.

In heating/DHW standby mode, if leaving water temperature is below 2°C, heat pump stops and water pump keeps running for 30min. If water temperature is still below 2°C heat pump turns to heating mode to protect from anti-freezing.

When water side heat exchanger anti-freeze protection occurs the system displays error code Pb and the unit stops running.

# OPTIMUS PRO Mono

## 5.8 Module Temperature Protection Control

This control protects the module from abnormally high temperatures.

Figure 3-5.3: Module Temperature Protection Control

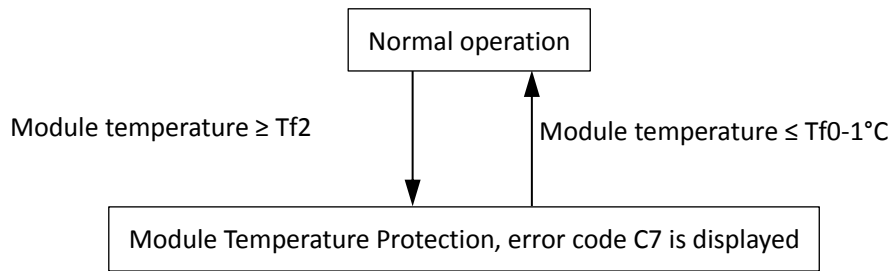

When the module temperature rises at or above Tf2 the system displays C7 protection and the unit stops running. When the module temperature drops at or below Tf0-1, the compressor enters re-start control.

	4-6kW	8-10kW	12-16kW 1ph	12-16kW 3ph
Tf2	75	81	100	84
Tf0	69	75	94	78

## 6 Special Control

### 6.1 Oil Return Operation

In order to prevent the compressor from running out of oil, the oil return operation is conducted to recover oil that has flowed out of the compressor and into the refrigerant piping. When the oil return operation is being conducted, the outdoor unit refrigerant system main PCB displays code d0.

Timing of oil return operation:

- When the compressor cumulative operating time with running rotation speed less than 42rps reaches 6 hours.

The oil return operation ceases when any one of the following three conditions occurs:

- Oil return operation duration reaches 5 minutes.
- Compressor stops.
- Mode change command is received.

Tables 3-6.1 show component control during oil return operation in cooling mode.

Table 3-6.1: Outdoor unit component control during oil return operation in cooling mode

Component	Wiring diagram label	4/6kW	8/10/12/ 14/16kW	Control functions and states
Inverter compressor	COMP	●	●	Runs at oil return operation rotation speed
DC fan motor	FAN	●	●	Controlled according to outdoor heat exchanger pipe temperature
Electronic expansion valve	EXV	●	●	304 (steps)
Four-way valve	ST	●	●	Off

Tables 3-6.2 show component control during oil return operation in heating and DHW modes.

Table 3-6.2: Outdoor unit component control during oil return operation in heating and DHW modes

Component	Wiring diagram label	4/6kW	8/10/12/ 14/16kW	Control functions and states
Inverter compressor	COMP	●	●	Runs at oil return operation rotation speed
DC fan motor	FAN	●	●	Controlled according to outdoor heat exchanger pipe temperature
Electronic expansion valve	EXV	●	●	304 (steps)
Four-way valve	ST	●	●	On

### 6.2 Defrosting Operation

In order to recover heating capacity, the defrosting operation is conducted when the outdoor unit air side heat exchanger is performing as a condenser. The defrosting operation is controlled according to outdoor ambient temperature, air side heat exchanger refrigerant outlet temperature and the compressor running time.

Table 3-6.3: Component control during defrosting operation

Component	Wiring diagram label	4/6kW	8/10/12/ 14/16kW	Control functions and states
Inverter compressor	COMP	●	●	Runs at defrosting operation rotation speed
DC fan motor	FAN	●	●	Off
Electronic expansion valve	EXV	●	●	Fully open
Four-way valve	ST	●	●	Off

# OPTIMUS PRO Mono

## 6.3 Fast DHW Operation

Fast DHW operation is used to quickly meet a requirement for domestic hot water when DHW priority has been set on the user interface. Refer to the OPTIMUS PRO Mono Engineering Data Book Part 3, 7.4 "DHW MODE SETTING Menu".

Domestic hot water demand priority can be ended by changing the switch on controller from "on" to "off".

Table 3-6.5: Component control during fast DHW operation

Component	Wiring diagram label	4/6kW	8/10/12/14/16kW	Control functions and states
Inverter compressor	COMP	•	•	Controlled according to load requirement
DC fan motor	FAN	•	•	Controlled according to outdoor heat exchanger pipe temperature
Electronic expansion valve	EXV	•	•	Position (steps) from 0 (fully closed) to 480 (fully open), controlled according to discharge superheat
Four-way valve	ST	•	•	On
Tank electric heater	TBH	•	•	On

## 6.4 Two zones control<sup>1</sup>

Two zones control function is used to control temperature of each zone separately, thus different type radiator will operate at its optimal temperature and water pump cycle time will be reduced to save energy.

In two zones control for cooling mode, when the setting temperature of a certain zones is reached, the zone and water pump of this zone will turn off.

In two zones control for heating mode, the on/off control of zone and water pump is same with cooling mode, but in addition, the mixing valve (3-way valve SV3) control function will be activated to adjust the water temperature of the low temperature zone by control the opening time and closing time of the valve. The mixing valve will only turn on when two zones control for heating is activated. On other conditions, the mixing valve will keep off.

When the valve initially turns on, the opening time and closing time is same and then the time is controlled according to the difference between water pipe temperature and setting water temperature of the controlling zone.

### Hydraulic adapter PCB (Optional)

With the help of hydraulic adapter PCB, totally 8 thermostats can be used at the same time for maximum 8 rooms to control heat pump.

Note:

1. OPTIMUS PRO units just have the controlling function, while the mixing valve, water pump of each zone need to be field supplied and connect to OPTIMUS PRO unit.

### 6.5 Smart grid control

Unit adjusts the operation according to different electrical signals to realize energy saving.

Free electric energy signal: DHW mode turn on, the setting temperature will be changed to 70°C automatically, and the TBH operate as below:  $T5 < 69$ , the TBH is on,  $T5 \geq 70$ , the TBH is off. The unit operate in cooling/heating mode as the normal logic.

Common electric energy signal: unit operates according to users' need.

Expensive electric energy signal: only available for cooling or heating mode and user can set the maximum operating time.

### 6.6 Balance tank temperature control

Balance tank temperature sensor is used to control on/off of heat pump.

Once the heat pump stops, internal pump stops to save energy and then balance tank provides hot water for space heating. In addition, balance tank temperature control can meet both space heating and domestic hot water needs at the same time. Balance tank can store energy to provide hot water whilst heat pump runs heat mode/cooling, which can reduce the host selection and the initial investment.

### 6.7 USB data transfer

- Convenient program upgrade

No need to carry any other heavy equipments but only USB can realize program upgrade of indoor unit and outdoor unit.

- Parameter setting transmission between wired controllers

Installer can quickly copy the setting from one controller to another via USB, which save the time of on-site installation.

### 6.8 Dry contract M1M2 control

M1M2 can be set in the wired controller for heat pump on/off control, TBH control, AHS control.

- For heat pump on/off control

When dry contract closes for 1s, heat pump stops. When dry contract opens for 5s, heat pump on/off according to wired controller or room thermostat setting.

- For TBH control

TBH is only controlled by M1M2. If dry contract closes,  $T5 < 65^{\circ}\text{C}$  then TBH opens until water tank temperature reaches 70°C.

- For AHS control

In heating mode, AHS on/off is only controlled by M1M2. In DHW mode, M1M2 control does not affect AHS on/off.



## 7 Role of Temperature Sensors in Control Functions

Figure 3-7.1: Location of the temperature sensors on 4~16KW unit systems

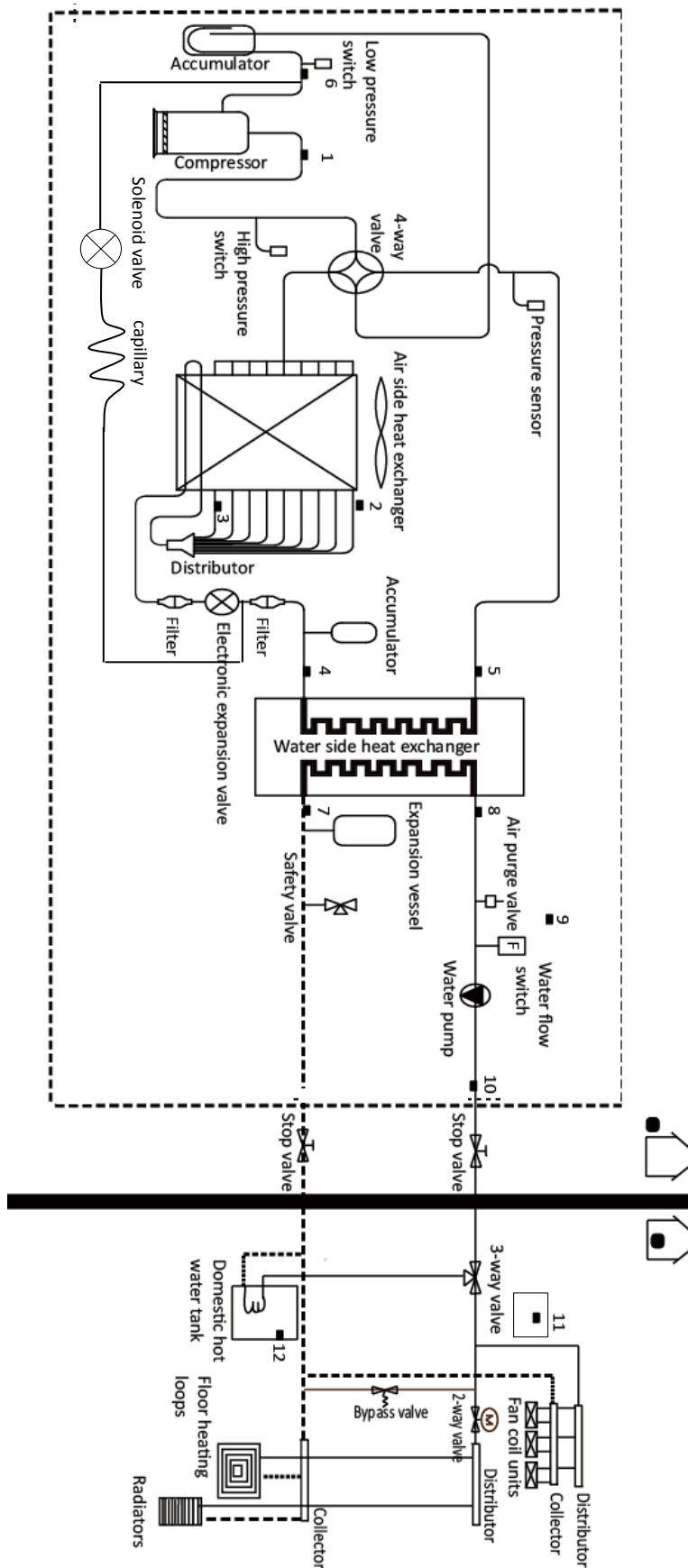

Notes:

1. The names and functions of the temperature sensors labelled 1 to 12 in this figure are detailed in Table 3-6.1.

Table 3-7.1: Names and functions of the temperature sensors

Number	Sensor name <sup>1</sup>	Sensor code	Mode	Control functions
1	Discharge pipe temperature sensor	Tp	Heating	<ul style="list-style-type: none"> <li>▪ Electronic expansion valve control<sup>2</sup></li> <li>▪ Discharge superheat control</li> </ul>
			Cooling	<ul style="list-style-type: none"> <li>▪ Electronic expansion valve control<sup>2</sup></li> <li>▪ Outdoor fan control<sup>3</sup></li> <li>▪ Discharge superheat control</li> </ul>
2	Outdoor ambient temperature sensor	T4	Heating	<ul style="list-style-type: none"> <li>▪ Compressor startup control<sup>4</sup></li> <li>▪ Compressor output control<sup>5</sup></li> <li>▪ Electronic expansion valve control<sup>2</sup></li> <li>▪ Defrosting operation control<sup>7</sup></li> <li>▪ Low pressure protection control<sup>7</sup></li> <li>▪ Crankcase heater control<sup>9</sup></li> </ul>
			Cooling	<ul style="list-style-type: none"> <li>▪ Compressor startup control<sup>4</sup></li> <li>▪ Compressor output control<sup>5</sup></li> <li>▪ Electronic expansion valve control<sup>2</sup></li> <li>▪ Outdoor fan control<sup>3</sup></li> <li>▪ Crankcase heater control<sup>9</sup></li> </ul>
3	Air side heat exchanger refrigerant outlet temperature sensor	T3	Heating	<ul style="list-style-type: none"> <li>▪ Electronic expansion valve control<sup>2</sup></li> <li>▪ Defrosting operation control<sup>7</sup></li> <li>▪ Outdoor fan control<sup>3</sup></li> </ul>
			Cooling	<ul style="list-style-type: none"> <li>▪ Compressor output control<sup>5</sup></li> <li>▪ Outdoor fan control<sup>3</sup></li> </ul>
4	Water side heat exchanger refrigerant inlet (liquid pipe) temperature sensor	T2	Heating	<ul style="list-style-type: none"> <li>▪ Compressor output control<sup>5</sup></li> </ul>
			DHW	
5	Water side heat exchanger refrigerant outlet (gas pipe) temperature sensor	T2B	Heating	<ul style="list-style-type: none"> <li>▪ Freeze prevention control<sup>10</sup></li> </ul>
6	Suction pipe temperature sensor	Th	Heating	<ul style="list-style-type: none"> <li>▪ Electronic expansion valve control<sup>2</sup></li> </ul>
			Cooling	
7	Water side heat exchanger water inlet temperature sensor	Tw_in	Heating	<ul style="list-style-type: none"> <li>▪ Freeze prevention control<sup>10</sup></li> </ul>
			Cooling	
8	Water side heat exchanger water outlet temperature sensor	Tw_out	Heating	<ul style="list-style-type: none"> <li>▪ Compressor output<sup>5</sup> and on/off control<sup>6</sup></li> <li>▪ Freeze prevention control<sup>10</sup></li> </ul>
			Cooling	
			DHW	
9	Backup electric heater water outlet temperature sensor	T1	Heating	<ul style="list-style-type: none"> <li>▪ Compressor output control<sup>5</sup></li> <li>▪ Backup electric heater control</li> <li>▪ DHW priority control<sup>11</sup></li> <li>▪ Auto mode control</li> </ul>
			Cooling	<ul style="list-style-type: none"> <li>▪ Compressor output<sup>5</sup> and on/off control<sup>6</sup></li> <li>▪ Auto mode control</li> </ul>
			DHW	<ul style="list-style-type: none"> <li>▪ Compressor output control<sup>5</sup></li> <li>▪ Backup electric heater control</li> <li>▪ DHW priority control<sup>11</sup></li> </ul>
10	Circuit 2 water outlet temperature sensor	T1B	Heating	<ul style="list-style-type: none"> <li>▪ Mixing valve control</li> </ul>
11	Room temperature sensor Built in wire controller	Ta	Heating	<ul style="list-style-type: none"> <li>▪ Auto mode control</li> <li>▪ Climate related curve</li> <li>▪ Compressor output control<sup>5</sup></li> </ul>
			Cooling	
12	Domestic hot water tank temperature sensor	T5	DHW	<ul style="list-style-type: none"> <li>▪ Disinfection operation control</li> <li>▪ DHW tank immersion heater control</li> <li>▪ Backup electric heater control</li> <li>▪ Auxiliary heat source control</li> <li>▪ Solar energy kit control</li> <li>▪ Compressor output control<sup>5</sup></li> <li>▪ DHW priority control<sup>11</sup></li> </ul>

Notes:

- |  |  |
|--|--|
| <ol style="list-style-type: none"> <li>1. Sensor names in this service manual referring to refrigerant flow is named according refrigerant flow during cooling operation refer to Part 2, 3 "Refrigerant Flow Diagrams".</li> <li>2. Refer to Part 3, 4.5 "Electronic Expansion Valve Control".</li> <li>3. Refer to Part 3, 4.6 "Outdoor Fan Control".</li> <li>4. Refer to Part 3, 3 "Startup Control".</li> <li>5. Refer to Part 3, 4.2 "Compressor Output Control".</li> </ol> | <ol style="list-style-type: none"> <li>6. Refer to Part 3, 1 "Stop Operation".</li> <li>7. Refer to Part 3, 6.2 "Defrosting Operation".</li> <li>8. Refer to Part 3, 5.2 "Low Pressure Protection Control".</li> <li>9. Refer to Part 3, 2.1 "Crankcase Heater Control".</li> <li>10. Refer to Part 3, 2.2 "Freeze Prevention Control".</li> <li>11. Refer to Part 3, 6.4 "Fast DHW Operation".</li> </ol> |
|--|--|



# Part 4

# Diagnosis and Troubleshooting

1 Outdoor Unit Electric Control Box Layout .....	32
2 Outdoor Unit PCBs .....	35
3 Error Code Table .....	49
4 Troubleshooting .....	52
5 Appendix to Part 4 .....	110

# OPTIMUS PRO Mono

## 1 Outdoor Unit Electric Control Box Layout

HOP4WMONO / HOP6WMONO

Figure 4-1.1: Electric control box front view

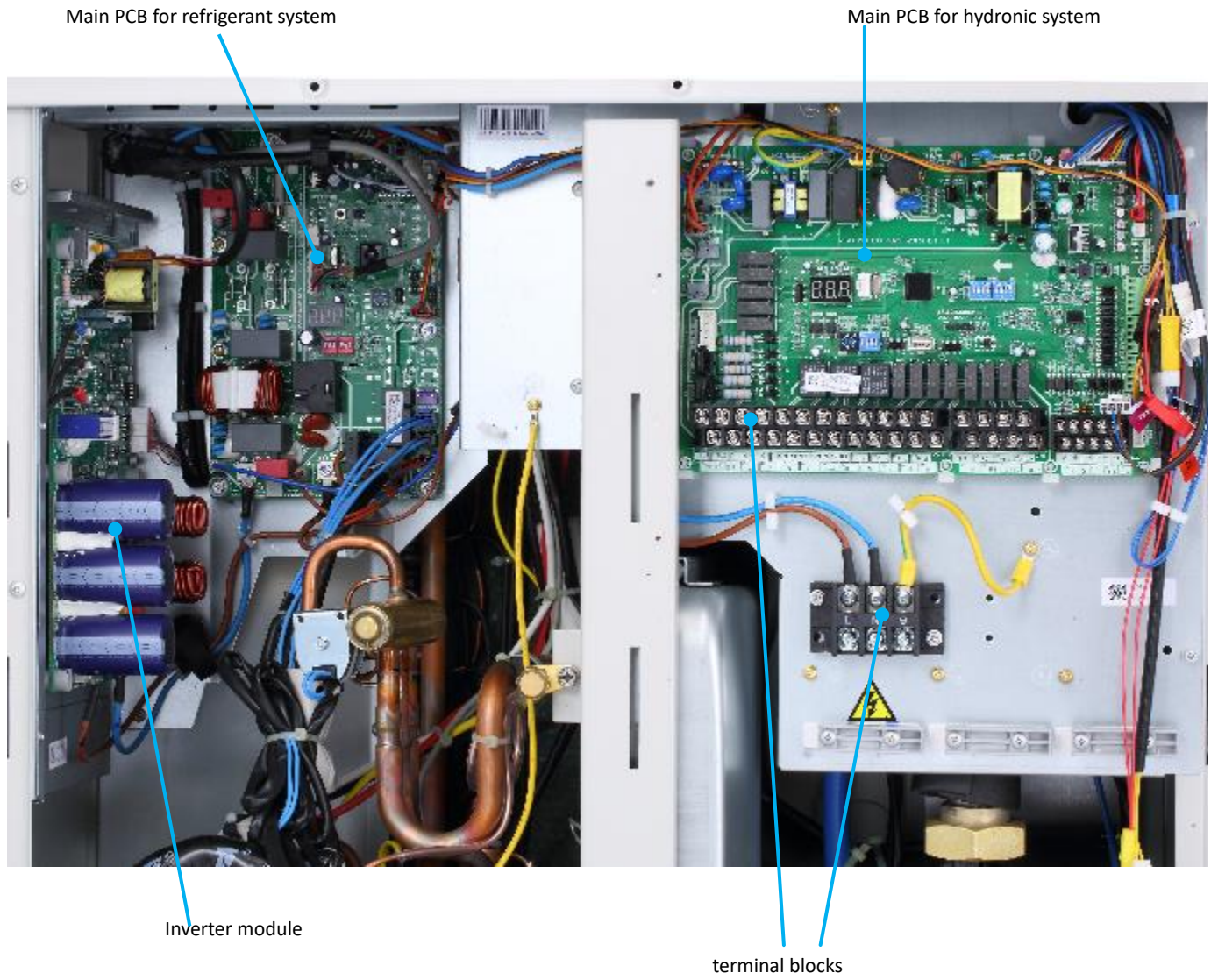



**HOP8WMONO / HOP10WMONO**

Figure 4-1.2: Electric control box front view

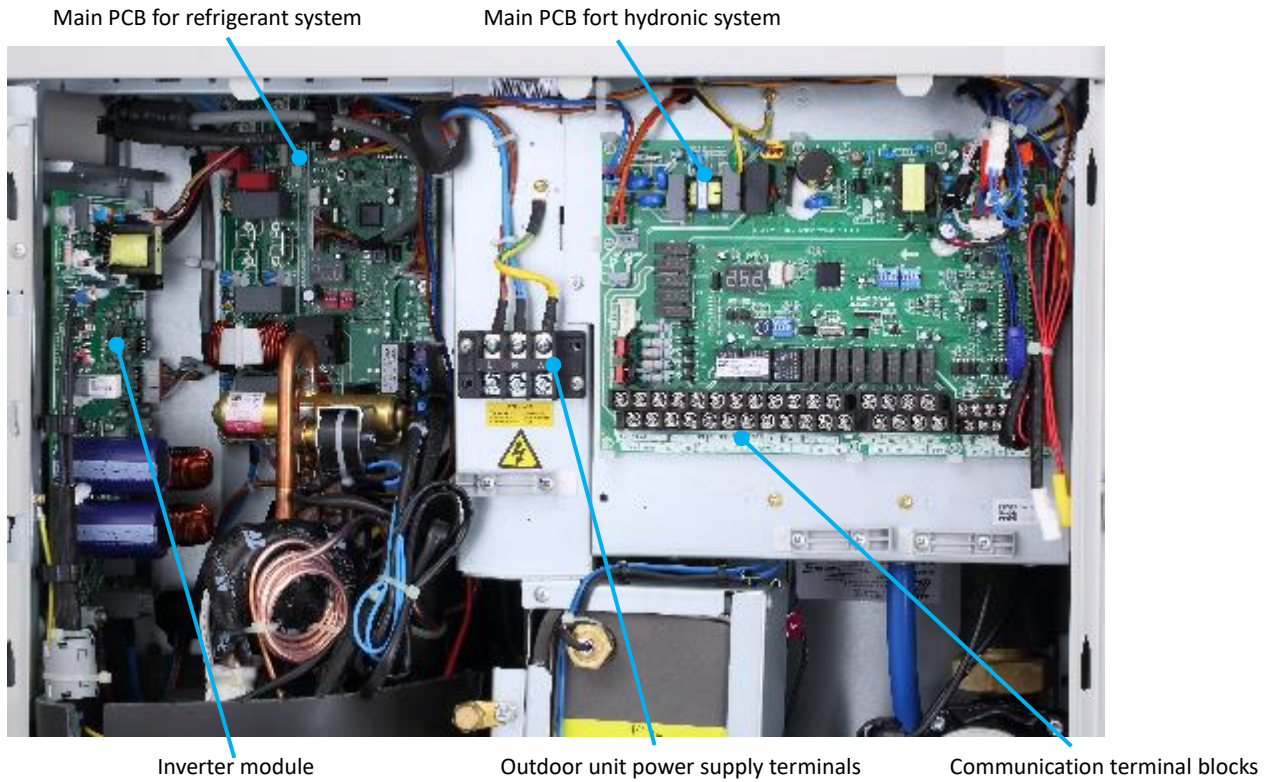

**HOP12WMONO / HOP14WMONO / HOP16WMONO**

Figure 4-1.3: Electric control box front view

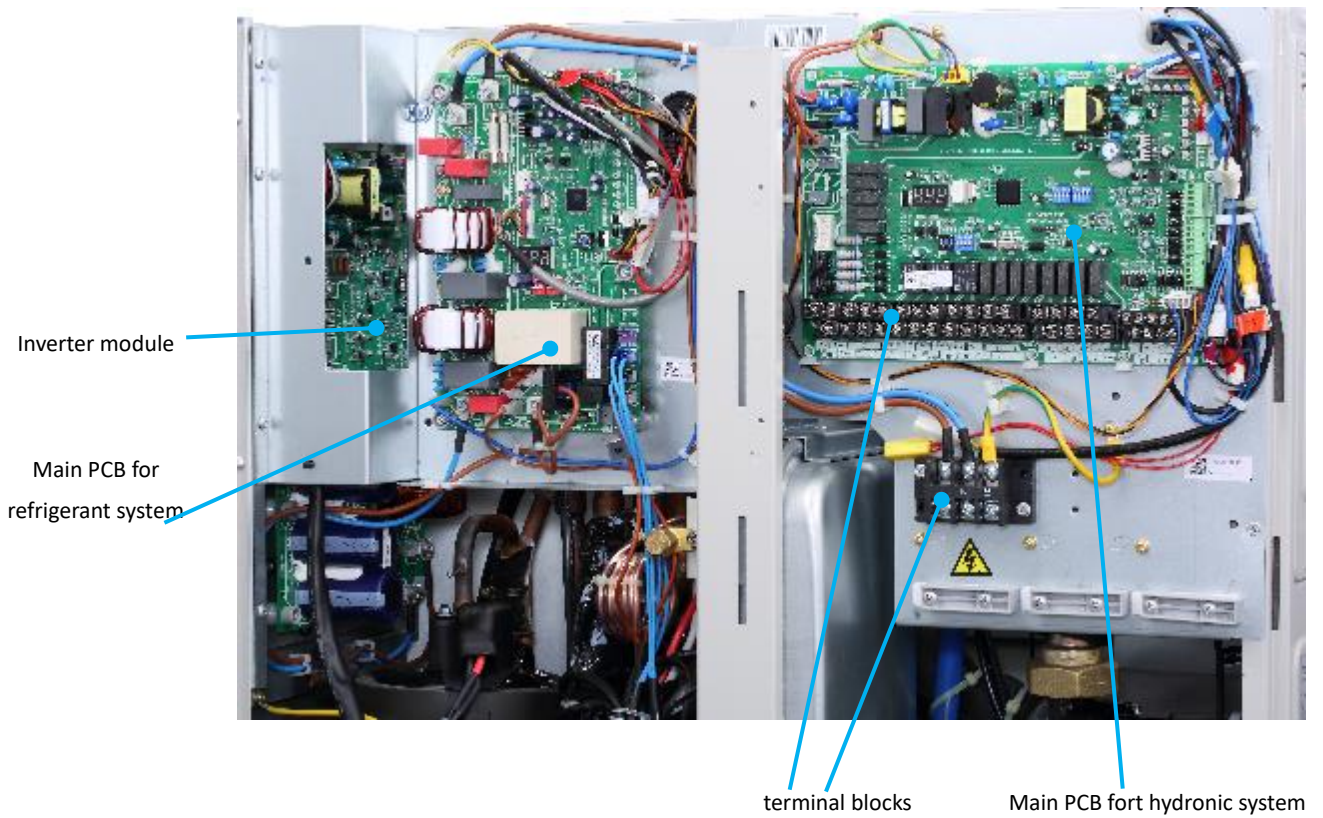

# OPTIMUS PRO Mono

HOP12WMONO3 / HOP14WMONO3 / HOP16WMONO3

Figure 4-1.4: Electric control box front view

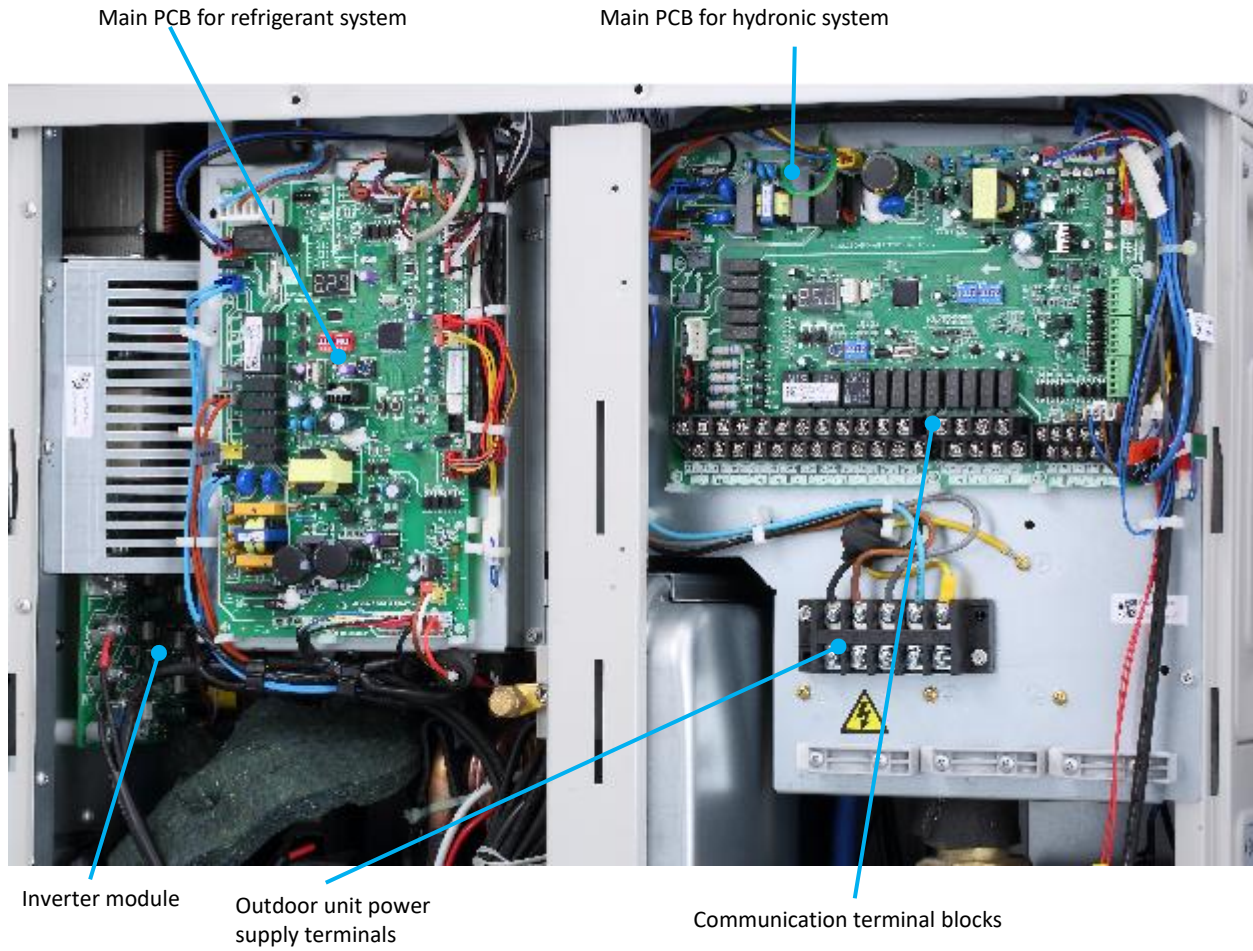



## 2 Outdoor Unit PCBs

### 2.1 Types

OPTIMUS PRO Mono outdoor units have two main PCBs – one for the hydronic system and one for the refrigerant system. The hydronic system main PCB is the same on all OPTIMUS PRO Mono models.

The locations of each PCB in the outdoor unit electric control boxes are shown in Figures 4-1.1 to 4-1.4 in Part 4, 1 “Outdoor Unit Electric Control Box Layout”.

### 2.2 Main PCB for Hydronic System

Figure 4-2.1: Outdoor unit main PCB for hydronic system

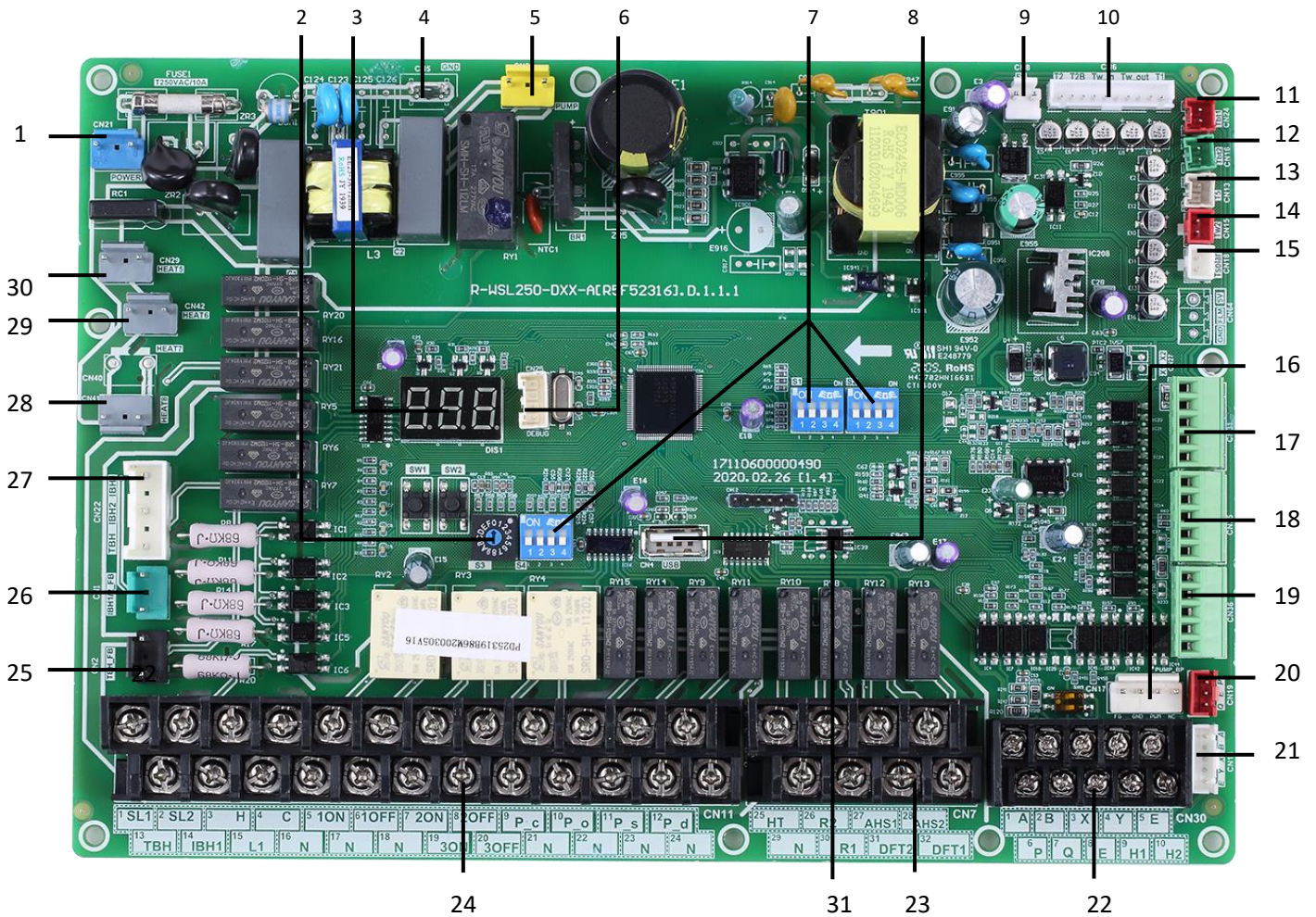



# OPTIMUS PRO Mono

Table 4-2.1: Main PCB for hydronic system

Label in Figure 4-2.1	Code	Content
1	CN21	Port for power supply
2	S3	Rotary dip switch
3	DIS1	Digital display
4	CN5	Port for ground
5	CN28	Port for internal pump
6	CN25	Port for IC programming
7	S1,S2,S4	Dip switch
8	CN4	Port for USB
9	CN8	Flow switch
10	CN6	Port for temp. sensors (T2,T2B,TW_out,TW_in, T1,)
11	CN24	Port for temp. sensor(Tbt1, The balanced water tank of up temp. sensor)
12	CN16	Port for temp. sensor(Tbt2, The balanced water tank of up temp. sensor)
13	CN13	Port for temp. sensor(T5, domestic hot water tank temp. sensor)
14	CN15	Port for temp. sensor(Tw2, The outlet water for zone 2 temp. sensor)
15	CN18	Port for temp. sensor(Tsolar, Solar panel temp. sensor)
16	CN17	Port for internal pump
17	CN31	Control port for room thermostat (heating mode)(HT)/Control port for room thermostat (cooling mode)(CL)/Power port for room thermostat(COM)
18	CN35	Port for smart grid (grid signal, photovoltaic signal)
19	CN36	Port for remote switch, temperature board
20	CN19	Communicate port between indoor unit and outdoor unit
21	CN14	Port for communication with the wired controller
22	CN30	Communicate port between indoor unit and outdoor unit, port for communication with the wired controller, internal machine parallel
23	CN7	Port for antifreeze E-heating tape(external), additional heat source, compressor run/defrost run
24	CN11	Control port for tank booster heater, internal backup heater 1, input port for solar energy, Port for room thermostat, SV1(3-way valve), SV2(3-way valve), SV3(3-way valve), zone 2 pump, outside circulation pump, solar energy pump, DHW pipe pump,
25	CN2	Feedback port for external temp. switch(shorted in default)
26	CN1	Feedback port for temperature switch
27	CN22	Control port for backup heater/booster heater
28	CN41	Port for anti-freeze electric heating tape
29	CN42	Port for anti-freeze electric heating tape
30	CN29	Port for anti-freeze electric heating tape
31	IC39	EEPROM

2.3 Main PCBs for Refrigerant System, Inverter Modules and filter board  
 HOP4WMONO / HOP6WMONO / HOP8WMONO / HOP10WMONO

Figure 4-2.2: HOP4(6,8,10)WMONO outdoor unit main PCB for refrigerant system

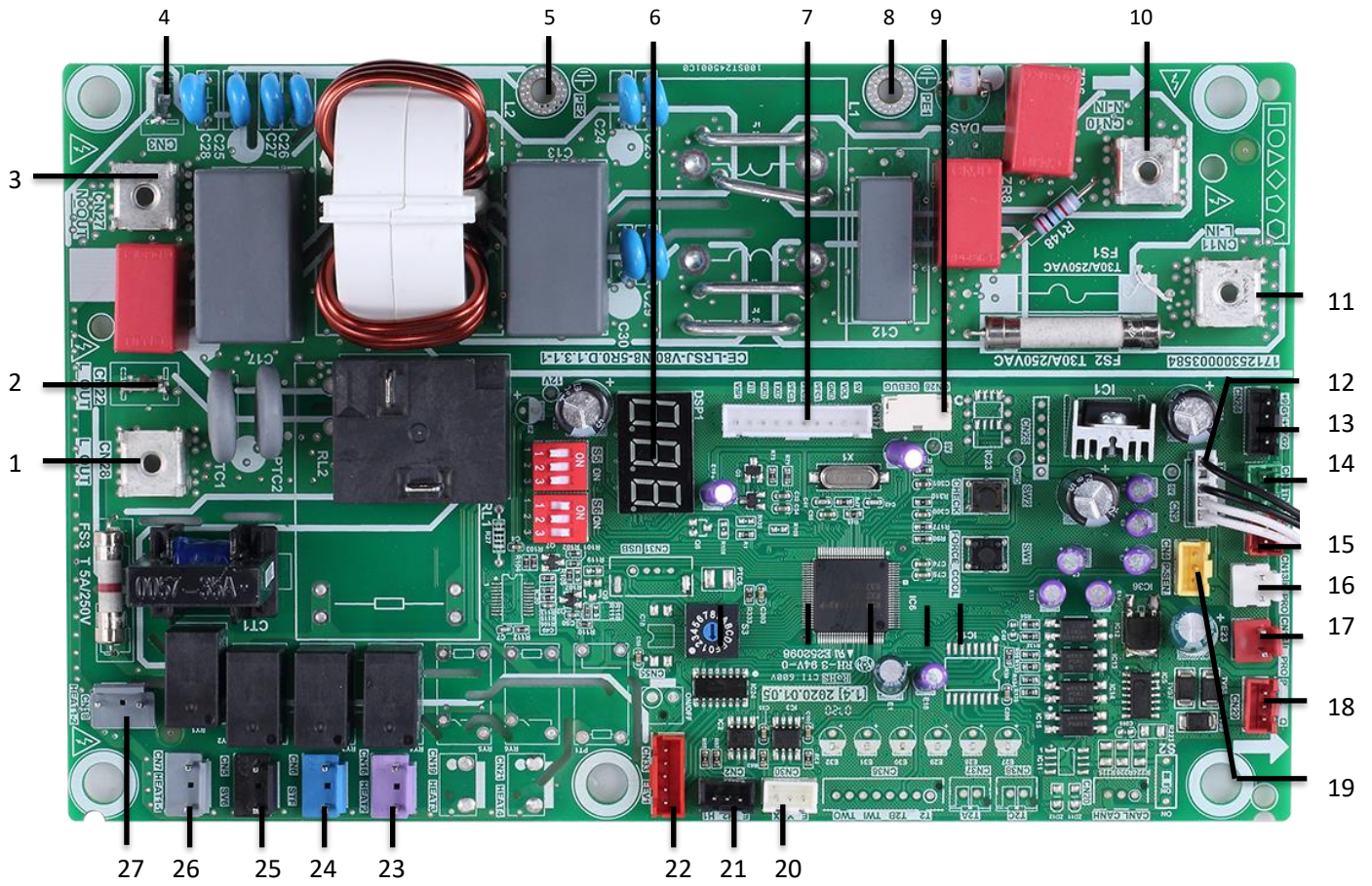

# OPTIMUS PRO Mono

Table 4-2.2: HOP4(6,8,10)WMONO outdoor unit main PCB for refrigerant system

Label in Figure 4-2.2	Code	Content
1	CN28	Output port L to MAIN CONTROL BOARD FOR REFRIGERANT SYSTEM
2	CN22	Reserved
3	CN27	Output port N to MAIN CONTROL BOARD FOR REFRIGERANT SYSTEM
4	CN3	Reserved
5	PE2	Port for ground wire
6	DSP1	Digital display
7	CN17	Port for communication with MAIN CONTROL BOARD FOR REFRIGERANT SYSTEM
8	PE1	Port for ground wire
9	CN26	Port for IC programming
10	CN10	Input port for neutral wire
11	CN11	Input port for live wire
12	CN9	Port for outdoor ambient temp. sensor and condenser temp. sensor
13	CN24	Input port for +12V/9V
14	CN1	Port for suction temp. sensor
15	CN8	Port for discharge temp. sensor
16	CN13	Port for high pressure switch
17	CN14	Port for low pressure switch
18	CN29	Port for communication with hydro-box control board
19	CN4	Port for pressure sensor
20	CN30	Port for communication(reserved)
21	CN2	Port for communication(reserved)
22	CN33	Port for electrical expansion valve
23	CN16	Reserved
24	CN6	Port for 4-way valve
25	CN5	Port for SV6 valve
26	CN7	Port for compressor electric heating tape 1
27	CN18	Port for compressor electric heating tape 2



Figure 4-2.3: HOP4(6)WMONO outdoor unit inverter module

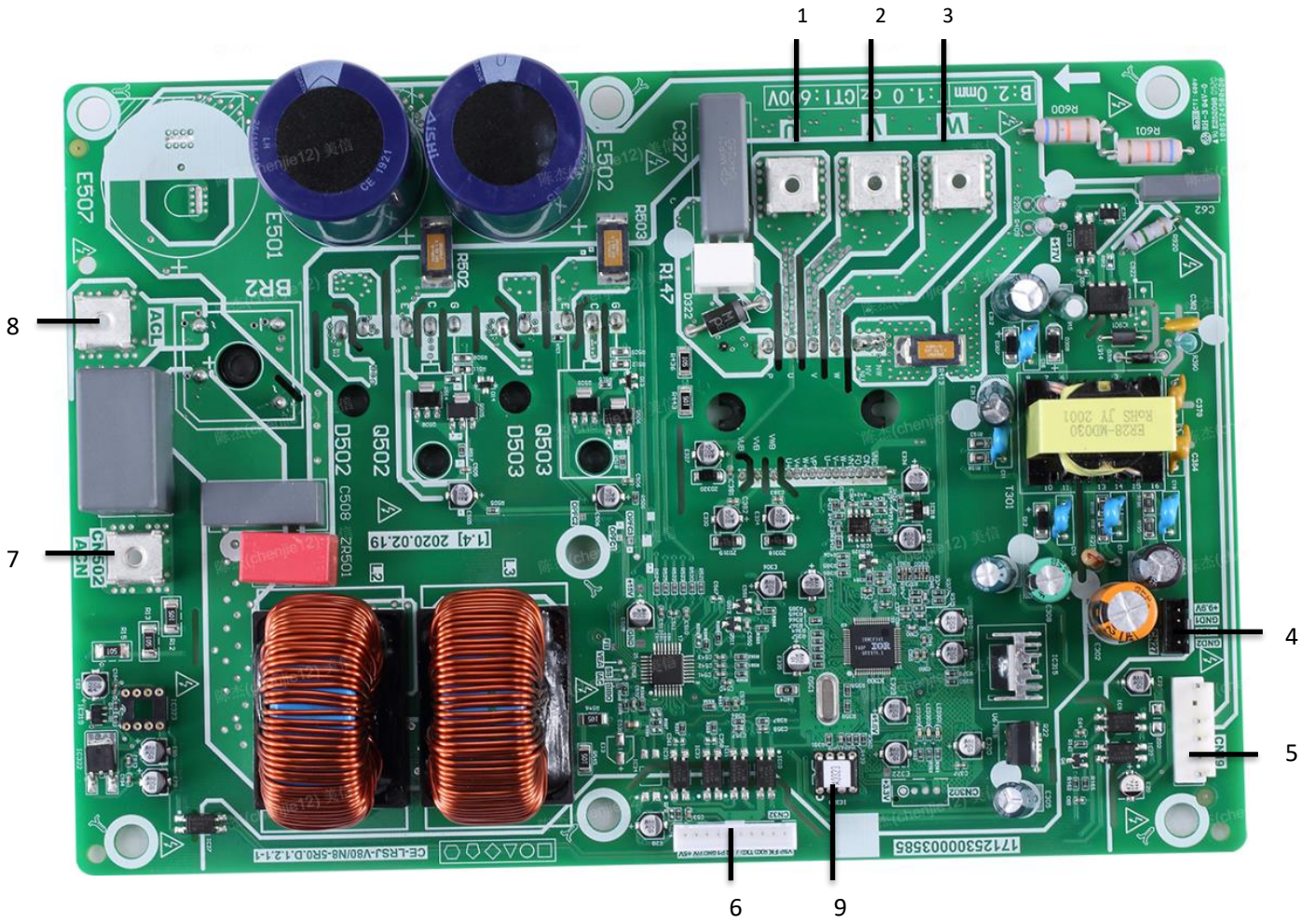

# OPTIMUS PRO Mono

Figure 4-2.3: HOP8(10)WMONO outdoor unit inverter module

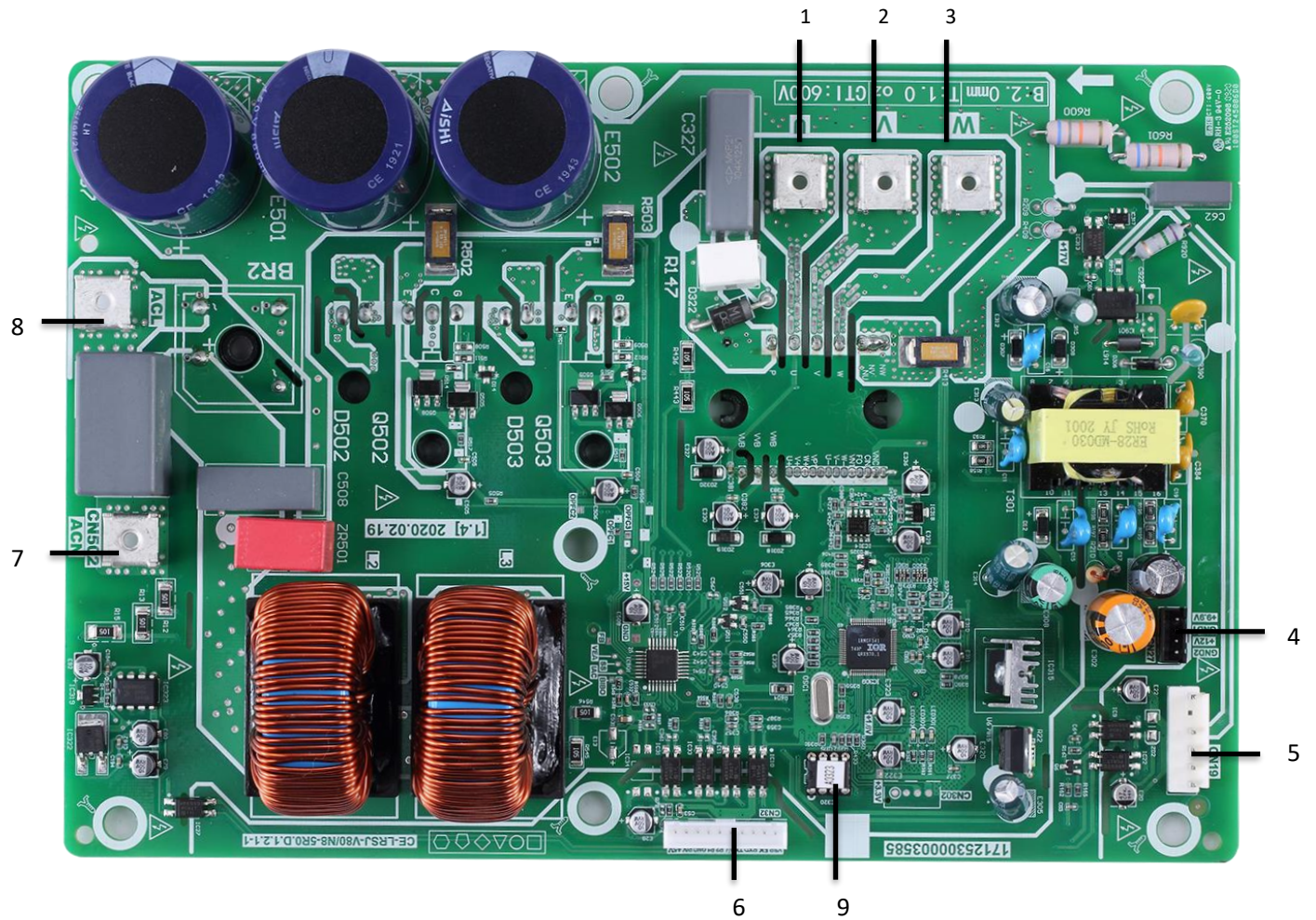

Table 4-2.3: HOP4(6,8,10)WMONO outdoor unit inverter module

Label in Figure 4-2.5	Code	Content
1	U	Compressor connection port U
2	V	Compressor connection port V
3	W	Compressor connection port W
4	CN20	Output port for +12V/5V
5	CN19	Port for fan
6	CN32	Port for communication with FILTER BOARD
7	CN502	Input port L for rectifier bridge
8	CN501	Input port N for rectifier bridge
9	IC320	EEPROM



HOP12WMONO / HOP14WMONO / HOP16WMONO

Figure 4-2.4: HOP12(14,16)WMONO outdoor unit main PCB for refrigerant system<sup>1</sup>

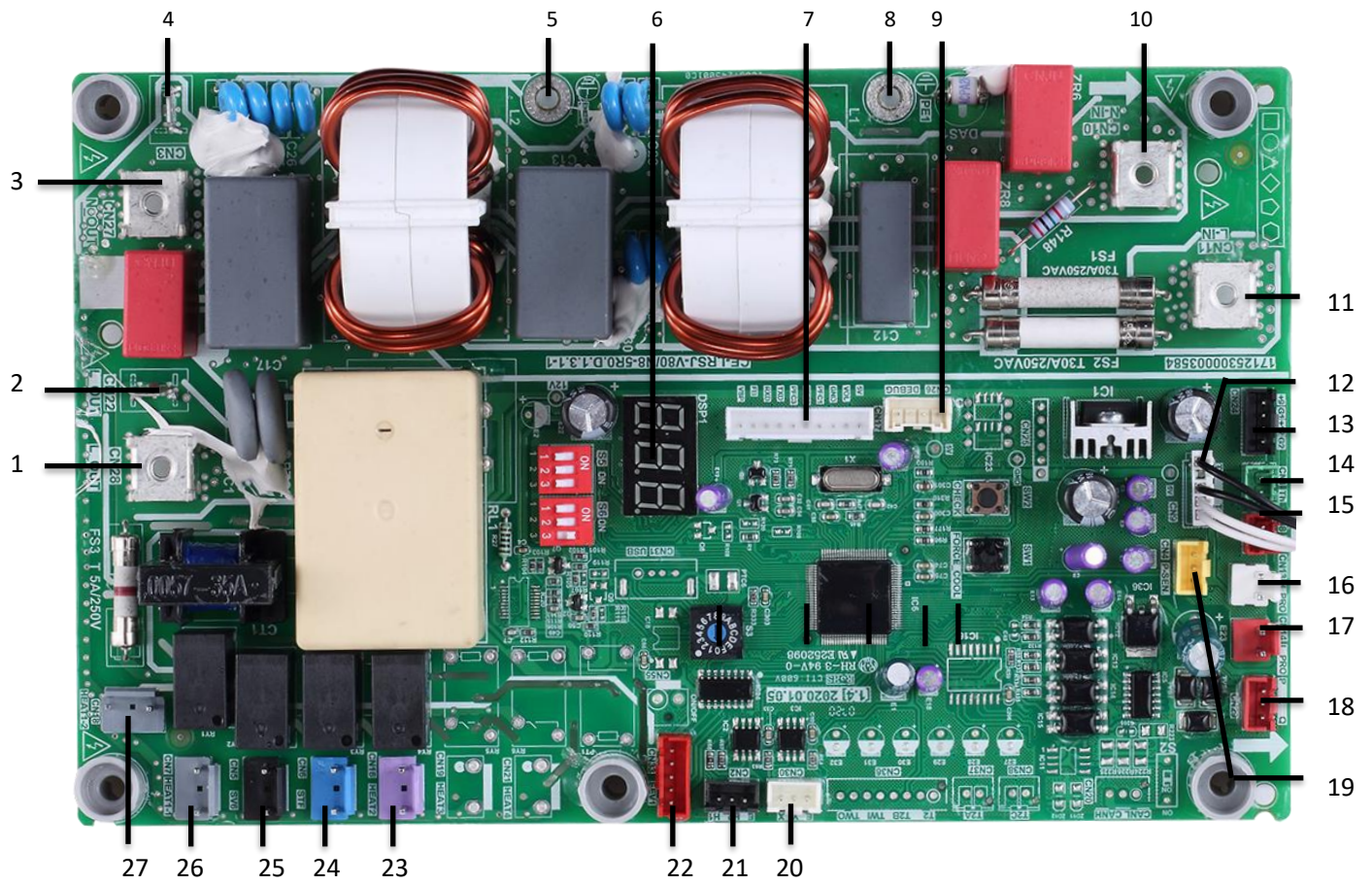

# OPTIMUS PRO Mono

Table 4-2.4: HOP12(14,16)WMONO outdoor unit main PCB for refrigerant system

Label in Figure 4-2.3	Code	Content
1	CN28	Output port L to MAIN CONTROL BOARD FOR REFRIGERANT SYSTEM
2	CN22	Reserved
3	CN27	Output port N to MAIN CONTROL BOARD FOR REFRIGERANT SYSTEM
4	CN3	Reserved
5	PE2	Port for ground wire
6	DSP1	Digital display
7	CN17	Port for communication with MAIN CONTROL BOARD FOR REFRIGERANT SYSTEM
8	PE1	Port for ground wire
9	CN26	Port for IC programming
10	CN10	Input port for neutral wire
11	CN11	Input port for live wire
12	CN9	Port for outdoor ambient temp. sensor and condenser temp. sensor
13	CN24	Input port for +12V/9V
14	CN1	Port for suction temp. sensor
15	CN8	Port for discharge temp. sensor
16	CN13	Port for high pressure switch
17	CN14	Port for low pressure switch
18	CN29	Port for communication with hydro-box control board
19	CN4	Port for pressure sensor
20	CN30	Port for communication(reserved)
21	CN2	Port for communication(reserved)
22	CN33	Port for electrical expansion valve
23	CN16	Reserved
24	CN6	Port for 4-way valve
25	CN5	Port for SV6 valve
26	CN7	Port for compressor electric heating tape 1
27	CN18	Port for compressor electric heating tape 2

Figure 4-2.5: HOP12(14,16)WMONO outdoor unit inverter module

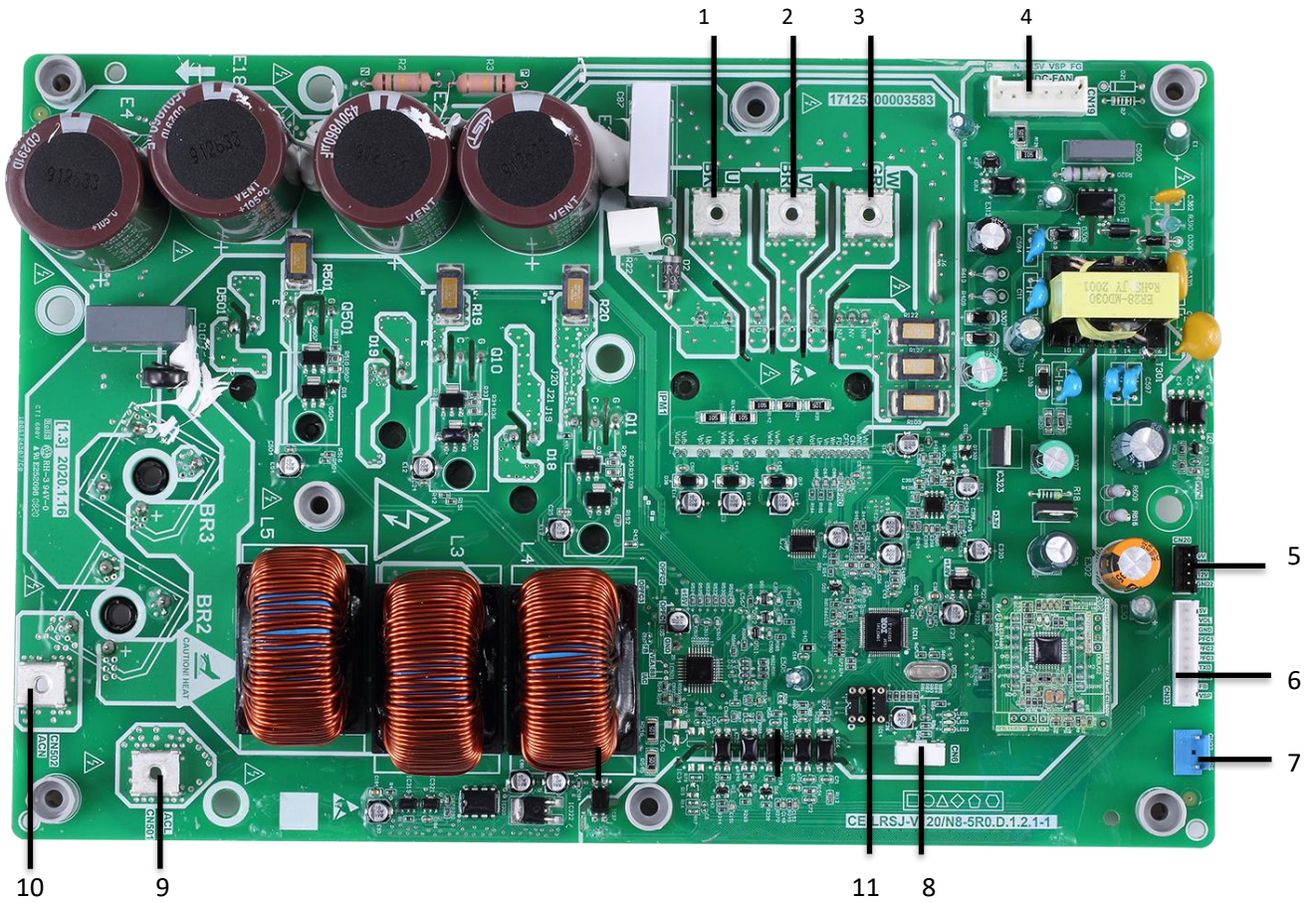

Table 4-2.5: HOP12(14,16)WMONO outdoor unit inverter module

Label in Figure 4-2.6	Code	Content
1	U	Compressor connection port U
2	V	Compressor connection port V
3	W	Compressor connection port W
4	CN19	Port for fan
5	CN20	Output port for +12V/9V
6	CN32	Port for communication with FILTER BOARD
7	CN23	Port for high pressure switch
8	CN6	Reserved
9	CN501	Input port L for rectifier bridge
10	CN502	Input port N for rectifier bridge
11	IC14	EEPROM



# OPTIMUS PRO Mono

HOP12WMONO3 / HOP14WMONO3/ HOP16WMONO3

Figure 4-2.6: HOP12(14,16)WMONO3 outdoor unit main PCB for refrigerant system<sup>1</sup>

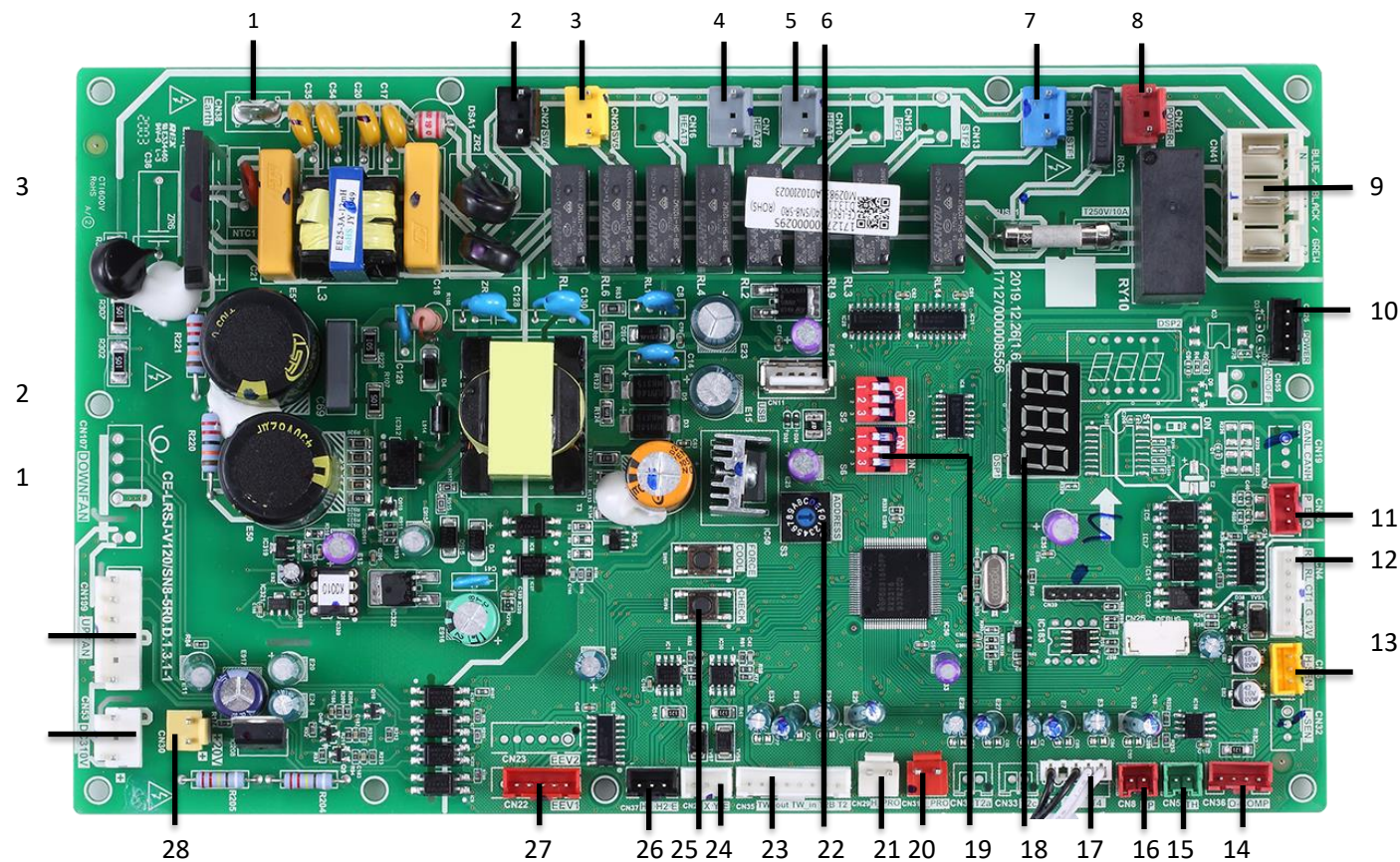

Table 4-2.6: HOP12(14,16)WMONO3 outdoor unit main PCB for refrigerant system

Label in Figure 4-2.4	Code	Content
1	CN38	Port for GND
2	CN27	Port for 2-way valve 5
3	CN20	Port for 2-way valve 6
4	CN10	Port for electric heating tape1
5	CN7	Port for electric heating tape2
6	CN11	Port for IC programming
7	CN18	Port for 4-way valve
8	CN21	Power supply port for hydro-box control board
9	CN41	Power supply port for FILTER BOARD
10	CN26	Port for communication with Power Meter
11	CN24	Port for communication with hydro-box control board
12	CN4	Port for communication with INVERT MODULE BOARD
13	CN6	Port for pressure sensor
14	CN36	Port for communication with MAIN CONTROL BOARD FOR REFRIGERANT SYSTEM(CN36)
15	CN4	Port for temp.sensor Tp(CN4)
16	CN8	Port for temp.sensor Th(CN8)
17	CN9	Port for outdoor ambient temp. sensor and condenser temp.sensor(CN9)
18	DSP1	Digital display(DSP1)
19	S5,S6	DIP switch(S5,S6)
20	CN31	Port for high pressure switch(CN31)
21	CN29	Port for low pressure switch and quick check(CN29)
22	S3	Rotary dip switch(S3)
23	CN35	Port for temp.sensors(TW_out, TW_in, T1, T2,T2B )
24	CN28	Port for communication XYE
25	S5, S6	DIP switch
26	CN37	Port for communication D1D2E
27	CN22	Port for electrical expansion valve
28	CN30	Port for fan 15VDC power supply
29	CN53	Port for fan 310VDC power supply
30	CN107	Port for fan



# OPTIMUS PRO Mono

Figure 4-2.7: HOP12(14,16)WMONO3 outdoor unit inverter module

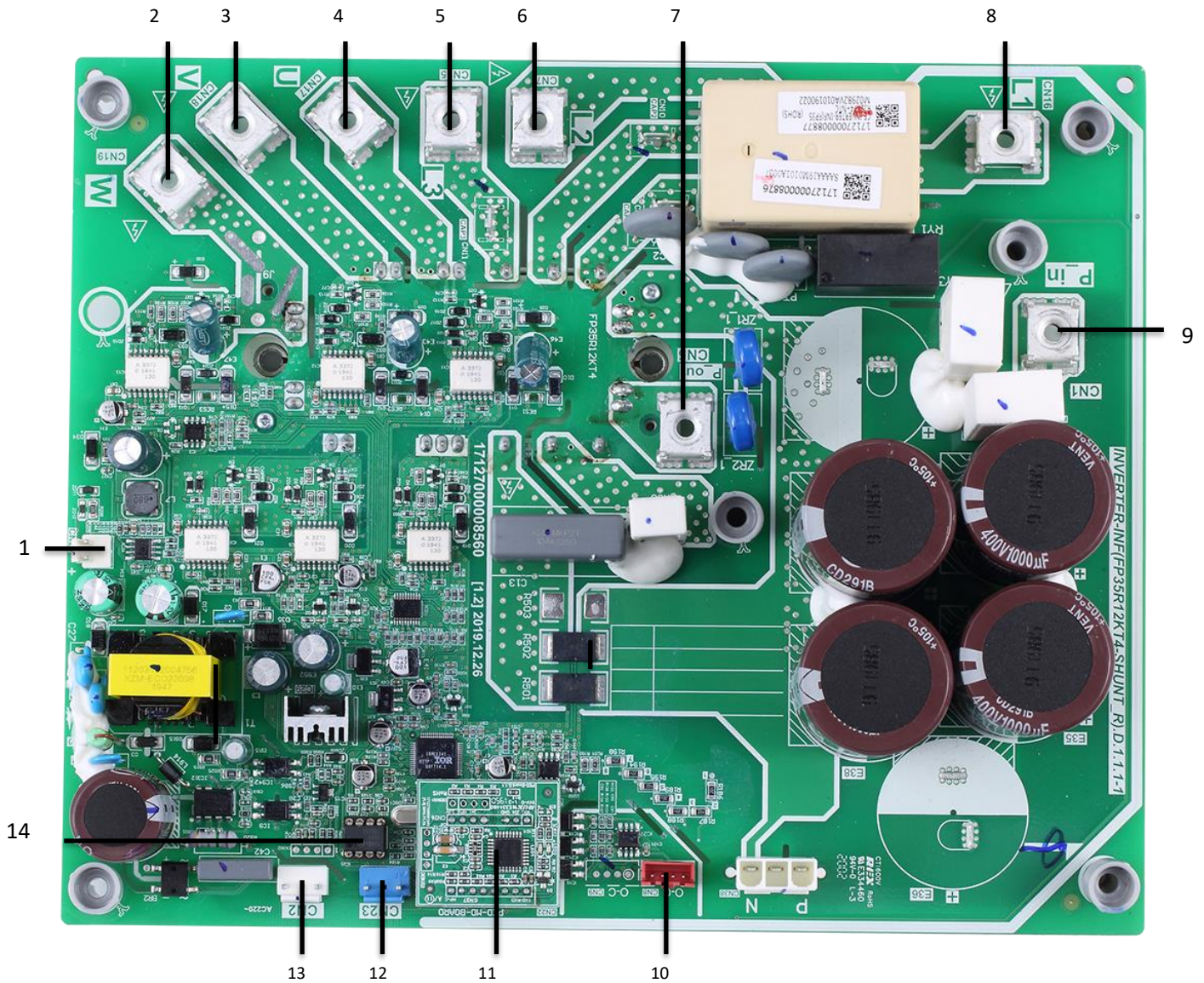

Table 4-2.7: HOP12(14,16)WMONO3 outdoor unit inverter module

Label in Figure 4-2.7	Code	Content
1	CN4	Output port for +15V
2	W	Compressor connection port W
3	V	Compressor connection port V
4	U	Compressor connection port U
5	L1	Power Input port L1
6	L2	Power Input port L2
7	P_out	Input port P_out for IPM module
8	L3	Power Input port L3
9	P_in	Input port P_in for IPM module
10	CN1	Port for communication with FILTER BOARD
11	CN22	Power for PED board
12	CN2	Power for switching power supply
13	CN23	Input port for high pressure switch
14	IC25	EEPROM



Figure 4-2.8: HOP12(14,16)WMONO3 outdoor unit filter board

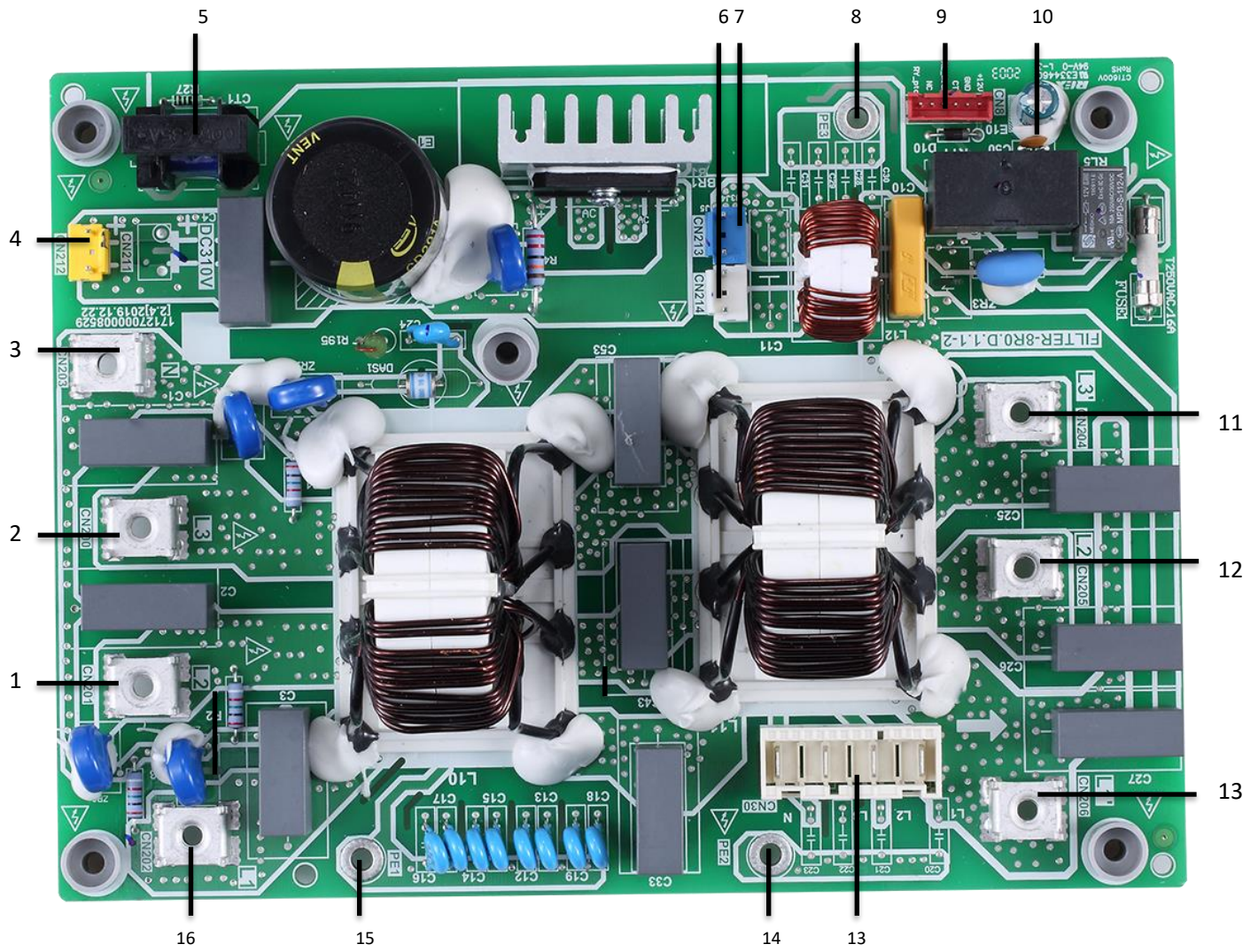

Table 4-2.8: HOP12(14,16)WMONO3 outdoor unit filter board

Label in Figure 4-2.8	Code	Content
1	CN201	Power supply L2
2	CN200	Power supply L3
3	CN203	Power supply N
4	CN212	Power supply port of 310VDC
5	CN211	Power supply port for load
6	CN213	Port for FAN Reactor
7	CN214	Power supply port for Inverter module
8	PE3	Ground wire
9	CN8	Port for communication with FILTER BOARD
10	L3'	Power filtering L3
11	L2'	Power filtering L2
12	L1'	Power filtering L1
13	CN30	Power supply port for main control board
14	PE2	Ground wire
15	PE1	Ground wire
16	L1	Power supply L1

# OPTIMUS PRO Mono

## 2.4 Digital Display Output

Table 4-2.9: Digital display output in different operating states

Outdoor unit state	Parameters displayed on hydronic system DSP1	Parameters displayed on refrigerant system DSP1
On standby	0	0
Normal operation	Leaving water temperature (°C)	Running speed of the compressor in rotations per second
Error or protection	Error or protection code	Error or protection code



## 2.5 DIP Switch Settings

The rotating coded switch S3(0-F) on the main control board of hydraulic module is used for setting the Modbus address. By defaulting the units have this coded switch positioned=0, but this corresponds to the Modbus address 16, while the others positions correspond the number, e.g. pos=2 is address 2, pos=5 is address 5.

Figure 4-2.9 Rotating switch



Figure 4-2.10: Connection

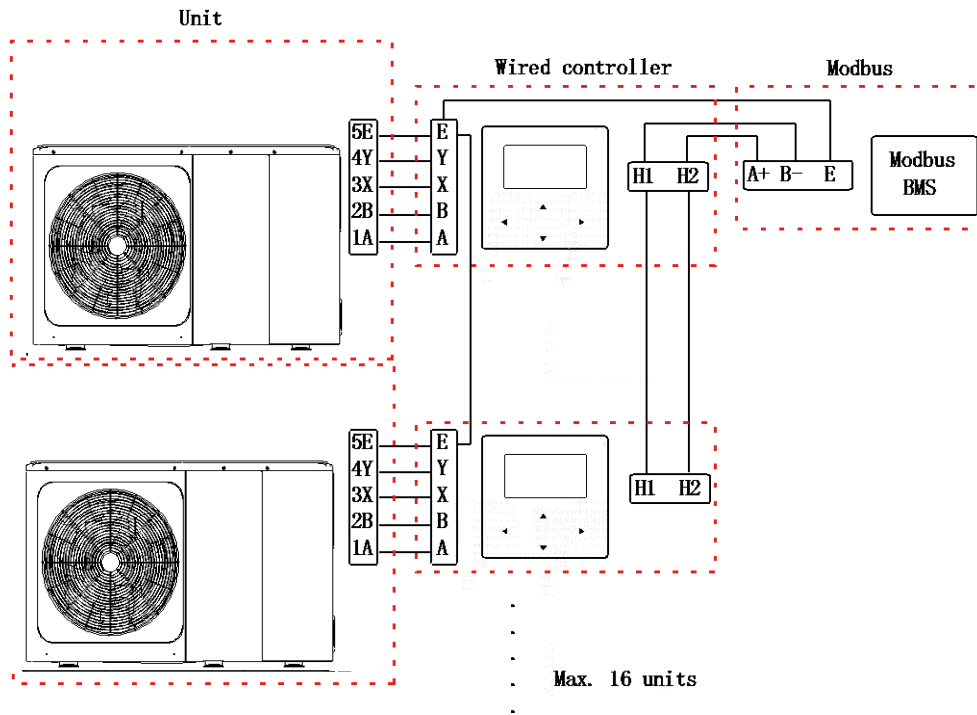
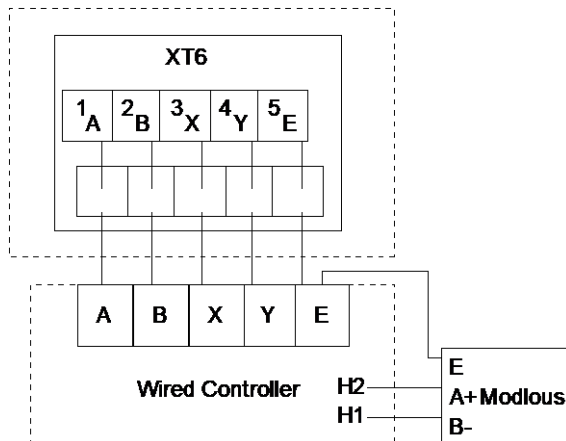

Figure 4-2.11: Wiring



### 3 Error Code Table

Table 4-3.1: Error code table

Error code	Serial number	Content <sup>1</sup>	Displayed on	Remarks
C7	65	Transducer module temperature too high protect	User interface and refrigerant system main PCB	Contact your local dealer
E0 E8	1 9	Water flow failure	User interface and hydronic system main PCB	
E1	2	Phase sequence error	User interface and refrigerant system main PCB	Only applies to 3-phase models
E2	3	Communication error between outdoor unit and user interface	User interface and hydronic system main PCB	
E3	4	Backup electric heater exchanger water outlet temperature sensor error	User interface and hydronic system main PCB	Sensor T1
E4	5	Domestic hot water tank temperature sensor error	User interface and hydronic system main PCB	Sensor T5
E5	6	Air side heat exchanger refrigerant outlet temperature sensor error	User interface and refrigerant system main PCB	Sensor T3
E6	7	Outdoor ambient temperature sensor error	User interface and refrigerant system main PCB	Sensor T4
E9	10	Suction pipe temperature sensor error	User interface and refrigerant system main PCB	Sensor Th
EA	11	Discharge pipe temperature sensor error	User interface and refrigerant system main PCB	Sensor Tp
Ed	14	Water side heat exchanger water inlet temperature sensor error	User interface and hydronic system main PCB	Sensor Tw_in
EE	15	Hydronic system EEPROM error	User interface and hydronic system main PCB	
F1	116	DC bus voltage is too low	User interface and refrigerant system main PCB	
H0	39	Communication error between refrigerant system main control chip and hydronic system main control chip	User interface, refrigerant system main control board for refrigerant system and hydronic system main PCB	
H1	40	Communication error between refrigerant system main control chip and inverter driver chip	User interface and refrigerant system main PCB	
H2	41	Water side heat exchanger refrigerant inlet (liquid pipe) temperature sensor error	User interface and hydronic system main PCB	Sensor T2
H3	42	Water side heat exchanger refrigerant outlet (gas pipe) temperature sensor error	User interface and hydronic system main PCB	Sensor T2B
H5	44	Room temperature sensor error	User interface and hydronic system main PCB	Sensor Ta
H6 HH	45 55	DC fan error	User interface and refrigerant system main PCB	
H7	46	Abnormal main circuit voltage	User interface and refrigerant system main PCB	

Table 4-3.1: Error code table (continued)

H8	47	Pressure sensor error	User interface and refrigerant system main PCB	
H9	48	Zone 2 water outlet temperature sensor error	User interface and hydronic system main PCB	Sensor T1B
HA	49	Water side heat exchanger water outlet temperature sensor error	User interface and hydronic system main PCB	Sensor Tw_out
HF	54	Refrigerant system EEPROM error	User interface and refrigerant system main PCB	
P0	20	Low pressure protection	User interface and refrigerant system main PCB	
HP	57			
P1	21	High pressure protection	User interface and refrigerant system main PCB	
P3	23	Compressor current protection	User interface and refrigerant system main PCB	
P4	24	Discharge temperature protection	User interface and refrigerant system main PCB	
P5	25	High temperature difference between water side heat exchanger water inlet and water outlet temperatures protection	User interface and hydronic system main PCB	
P6	26	Inverter module protection	User interface	Displayed on user interface when any of L0, L1, L2, L4, L5, L7, L8 or L9 occur
H4	43			
L0	-	Inverter module protection	Refrigerant system main PCB	
L1	-	DC bus low voltage protection	Refrigerant system main PCB	
L2	-	DC bus high voltage protection	Refrigerant system main PCB	
L4	-	MCE error	Refrigerant system main PCB	
L5	-	Zero speed protection	Refrigerant system main PCB	
L7	-	Phase sequence error	Refrigerant system main PCB	
L8	-	Compressor frequency variation greater than 15Hz within one second protection	Refrigerant system main PCB	
L9	-	Actual compressor frequency differs from target frequency by more than 15Hz protection	Refrigerant system main PCB	
Pb	31	Water side heat exchanger anti-freeze protection	User interface and hydronic system main PCB	
Pd	33	High temperature protection of refrigerant outlet temperature of condenser in cooling mode	User interface and refrigerant system main PCB	
PP	38	Water side heat exchanger inlet temperature is higher than outlet temperature in heating mode	user interface and hydronic system main PCB	
bH	112	PED board error		

Notes:

1. Sensor names in this service manual referring to refrigerant flow is named according refrigerant flow during cooling operation refer to Part 2, 3 "Refrigerant Flow Diagrams".
2. When the error code appears, the error code corresponding to the error code can be obtained through the H1H2 port by using the host computer to query the wired controller register.





## 4 Troubleshooting

### 4.1 Warning

#### Warning



- All electrical work must be carried out by competent and suitably qualified, certified and accredited professionals and in accordance with all applicable legislation (all national, local and other laws, standards, codes, rules, regulations and other legislation that apply in a given situation).
- Power-off the outdoor units before connecting or disconnecting any connections or wiring, otherwise electric shock (which can cause physical injury or death) may occur or damage to components may occur.

## 4.2 E0, E8 Troubleshooting

### 4.2.1 Digital display output

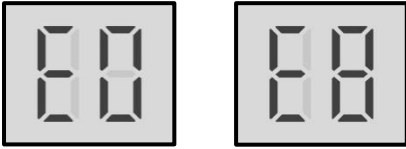

### 4.2.2 Description

- Water flow failure.
- E0 indicates E8 has displayed 3 times. When an E0 error occurs, a manual system restart is required before the system can resume operation.
- OPTIMUS PRO Mono stops running.
- Error code is displayed on hydronic system main control board for refrigerant system and user interface.

### 4.2.3 Possible causes

- The wire circuit is short connected or open.
- Water flow rate is too low.
- Water flow switch damaged.

## 4.2.4 Procedure

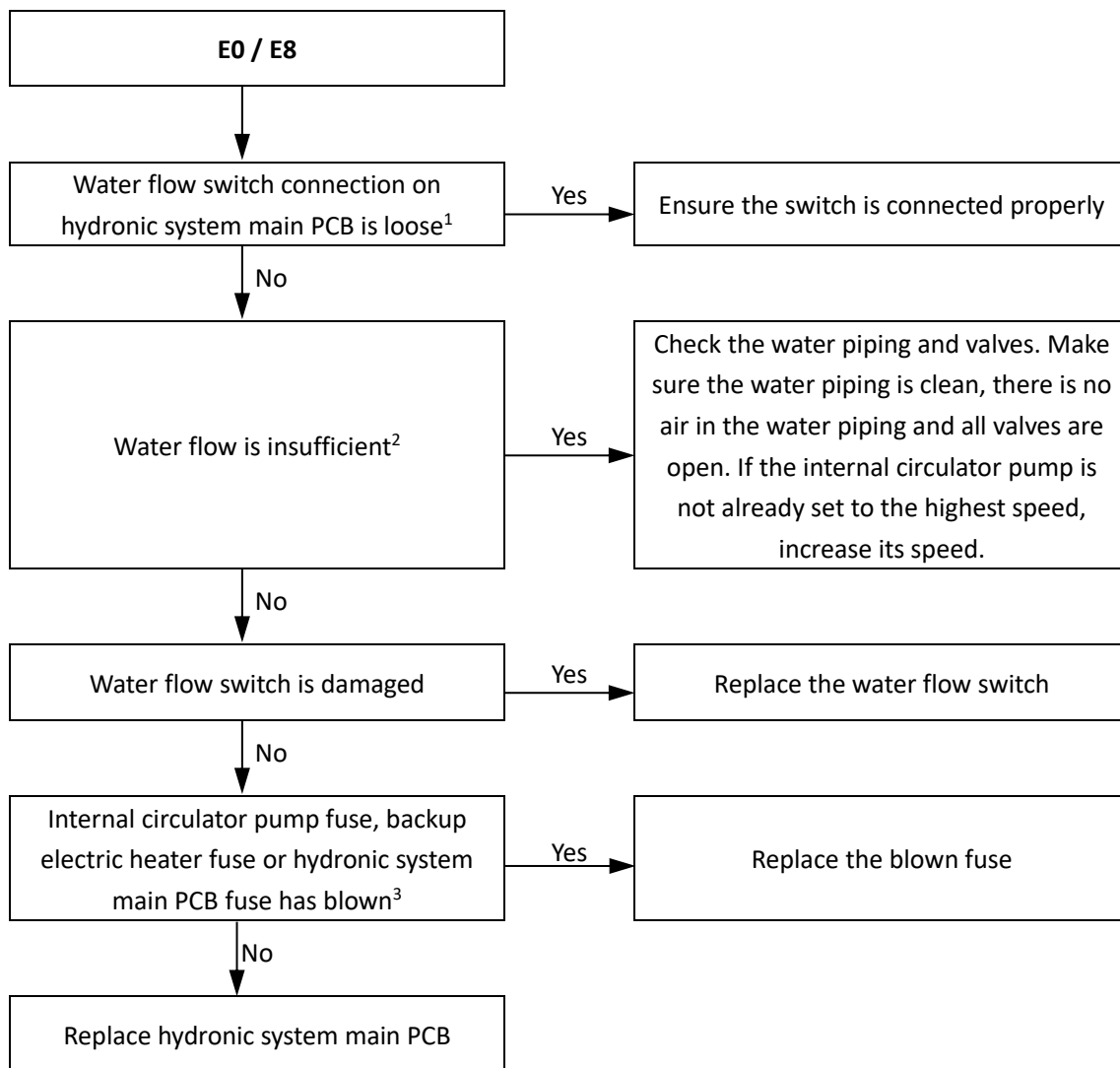

Notes:

1. Water flow switch connection is port CN8 on the main PCB for hydronic system (labeled 5 in Figure 4-2.1 in Part 4, 2.2 "Main PCB for Hydronic System").
2. Check water pressure on the manometer. If the water pressure is not > 1 bar, water flow is insufficient. Refer to Figure 2-1.2 and 2-1.6 in Part 2, 1 "Layout of Functional Components".
3. The fuse is labeled 25 in Figure 4-2.1 in Part 4, 2.2 "Main PCB for Hydronic System".

## 4.3 E1 Troubleshooting

### 4.3.1 Digital display output



### 4.3.2 Description

- Phase sequence error.
- Only applies to 3-phase models.
- OPTIMUS PRO Mono stops running.
- Error code is displayed on refrigerant system main control board for refrigerant system and user interface.

### 4.3.3 Possible causes

- Power supply phases not connected in correct sequence.
- Power supply terminals loose.
- Power supply abnormal.
- Main PCB damaged.

## 4.3.4 Procedure

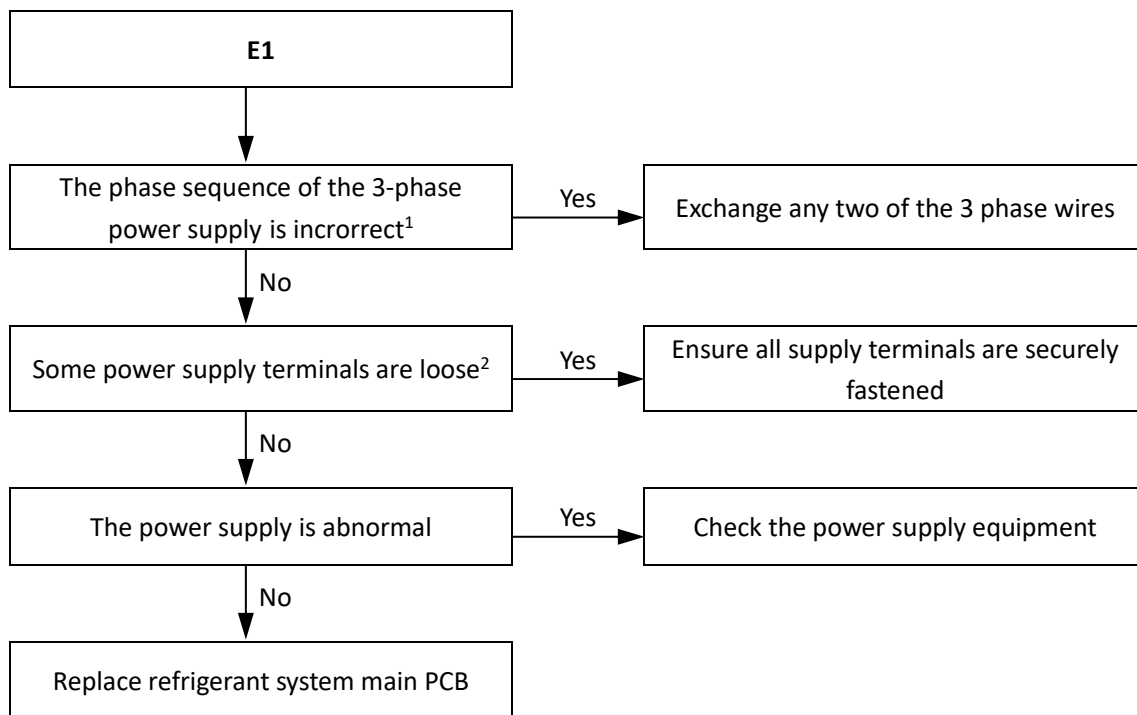

Notes:

1. The A, B, C terminals of 3-phase power supply should match compressor phase sequence requirements. If the phase sequence is inverted, the compressor will operate inversely. If the wiring connection of each outdoor unit is in A, B, C phase sequence, and multiple units are connected, the current difference between C phase and A, B phases will be very large as the power supply load of each outdoor unit will be on C phase. This can easily lead to tripped circuits and terminal wiring burnout. Therefore if multiple units are to be used, the phase sequence should be staggered, so that the current is distributed among the three phases equally.
2. Loose power supply terminals can cause the compressors to operate abnormally and compressor current to be very large.

## 4.4 E2 Troubleshooting

### 4.4.1 Digital display output



### 4.4.2 Description

- Communication error between outdoor unit and user interface.
- OPTIMUS PRO Mono stops running.
- Error code is displayed on hydronic system main control board for refrigerant system and user interface.

### 4.4.3 Possible causes

- Communication wires between outdoor unit and user interface not connected properly.
- Communication wiring X Y E terminals misconnected.
- Loosened wiring within electric control box.
- Interference from high voltage wires or other sources of electromagnetic radiation.
- Damaged main PCB or electric control box communication terminals block.

# OPTIMUS PRO Mono

## 4.4.4 Procedure

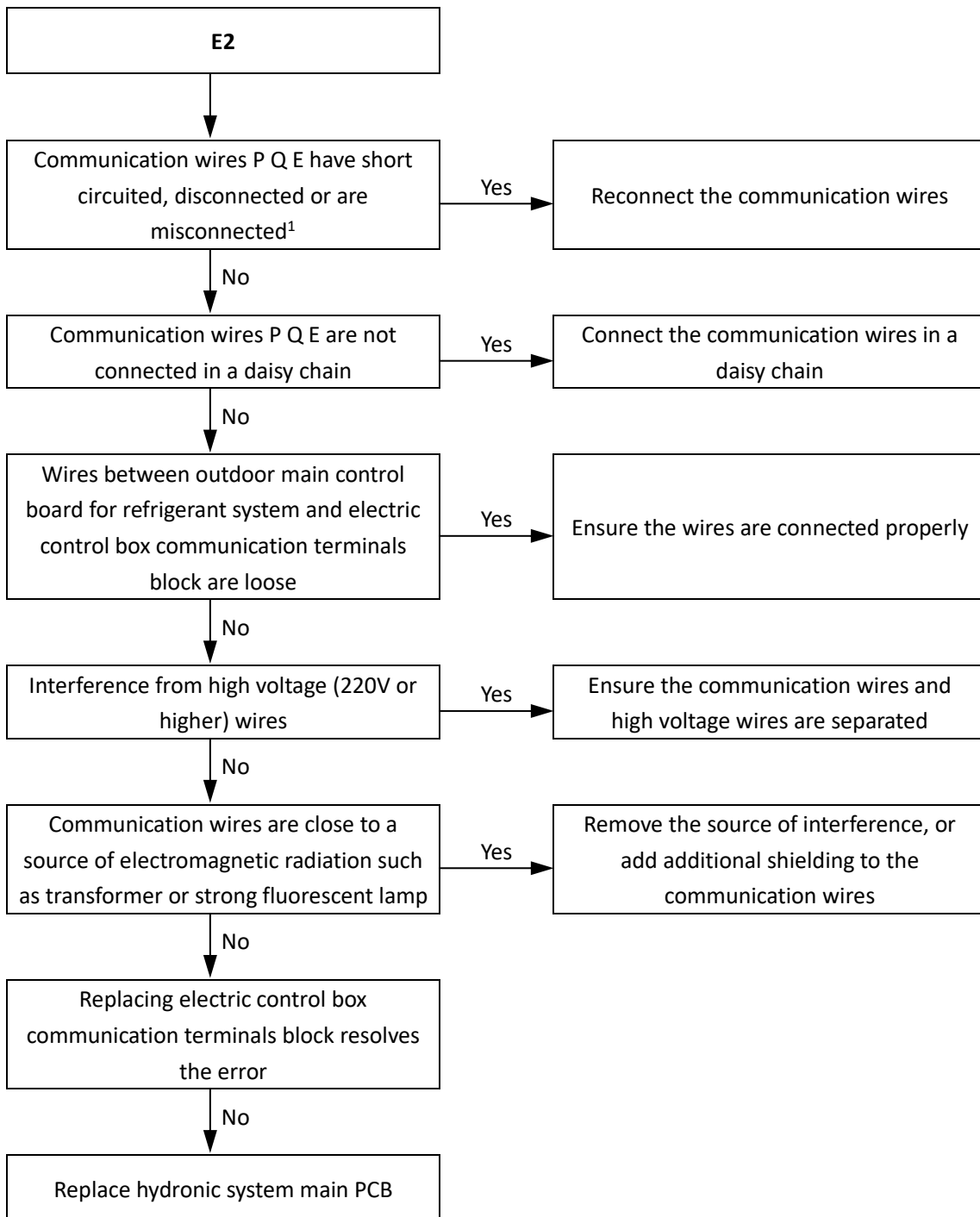

### Notes:

1. Measure the resistance among P, Q and E. The normal resistance between P and Q is 120Ω, between P and E is infinite, between Q and E is infinite. Communication wiring has polarity. Ensure that the P wire is connected to P terminals and the Q wire is connected to Q terminals.

## 4.5 E3, E4, H2, H3, Ed, HA, H5, H9 Troubleshooting

### 4.5.1 Digital display output

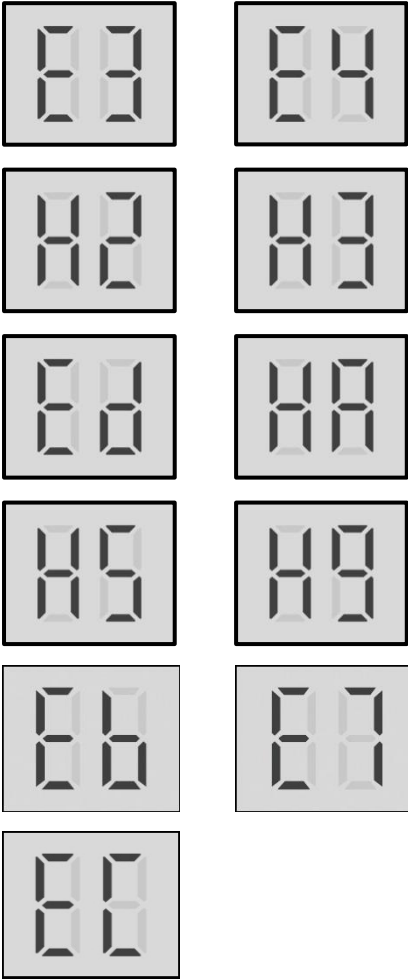

### 4.5.2 Description

- E3 indicates a backup electric heater water outlet temperature sensor error.
- E4 indicates a domestic hot water tank temperature sensor error.
- H2 indicates a water side heat exchanger refrigerant outlet (liquid pipe) temperature sensor error.
- H3 indicates a water side heat exchanger refrigerant inlet (gas pipe) temperature sensor error.
- Ed indicates a water side heat exchanger water inlet temperature sensor error.
- HA indicates a water side heat exchanger water outlet temperature sensor error.
- H5 indicates a room temperature sensor error.
- H9 indicates a zone 2 water outlet temperature sensor error.
- Eb indicates solar panel temperature sensor error
- E7 indicates balance tank upper temperature sensor error
- EC indicates balance tank nether temperature sensor error
- OPTIMUS PRO Mono stops running.
- Error code is displayed on hydronic system main control board for refrigerant system and user interface.

### 4.5.3 Possible causes

- Temperature sensor not connected properly or has malfunctioned.
- Damaged hydronic system main PCB.



# OPTIMUS PRO Mono

## 4.5.4 Procedure

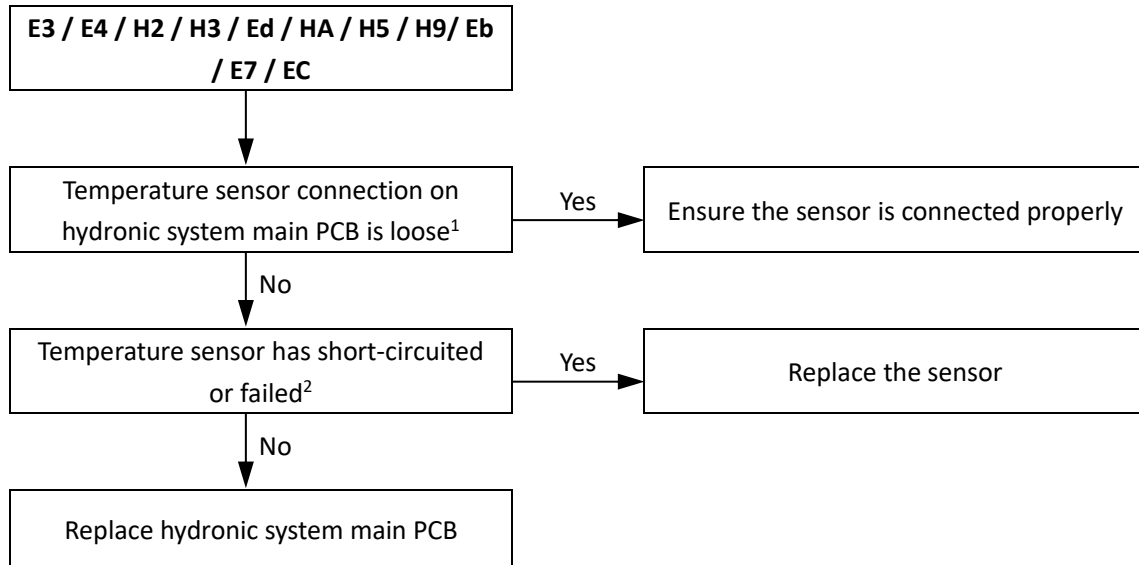

### Notes:

1. Backup electric heater water outlet temperature sensor, water side heat exchanger refrigerant inlet (liquid pipe) temperature sensor, water side heat exchanger refrigerant outlet (gas pipe) temperature sensor, water side heat exchanger water inlet temperature sensor and water side heat exchanger water outlet temperature sensor connections are port CN6 on the hydronic system main PCB (labeled 8 in Figure 4-2.1 in Part 4, 2.2 "Main PCB for Hydronic System"). Domestic hot water tank temperature sensor connection is port CN13 on the hydronic system main PCB (labeled 9 in Figure 4-2.1 in Part 4, 2.2 "Main PCB for Hydronic System"). Circuit 2 water outlet temperature sensor connection is port CN15 on the hydronic system main PCB (labeled 10 in Figure 4-2.1 in Part 4, 2.2 "Main PCB for Hydronic System"). Room thermostat connection is port CN3 on the hydronic system main PCB (labeled 28 in Figure 4-2.1 in Part 4, 2.2 "Main PCB for Hydronic System").
2. Measure sensor resistance. If the resistance is too low, the sensor has short-circuited. If the resistance is not consistent with the sensor's resistance characteristics table, the sensor has failed. Refer to Table 4-5.1 or 4-5.3 in Part 4, 5.1 "Temperature Sensor Resistance Characteristics".

## 4.6 E5, E6, E9, EA Troubleshooting

### 4.6.1 Digital display output

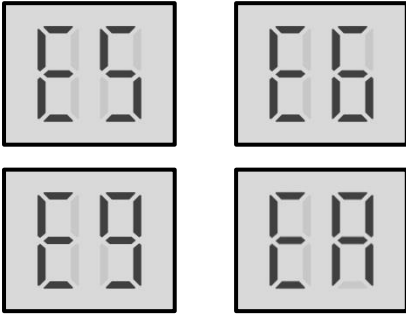

### 4.6.2 Description

- E5 indicates an air side heat exchanger refrigerant outlet temperature sensor error.
- E6 indicates an outdoor ambient temperature sensor error.
- E9 indicates a suction pipe temperature sensor error.
- EA indicates a discharge temperature sensor error.
- OPTIMUS PRO Mono stops running.
- Error code is displayed on refrigerant system main control board for refrigerant system and user interface.

### 4.6.3 Possible causes

- Temperature sensor not connected properly or has malfunctioned.
- Damaged refrigerant system main PCB.

## 4.6.4 Procedure

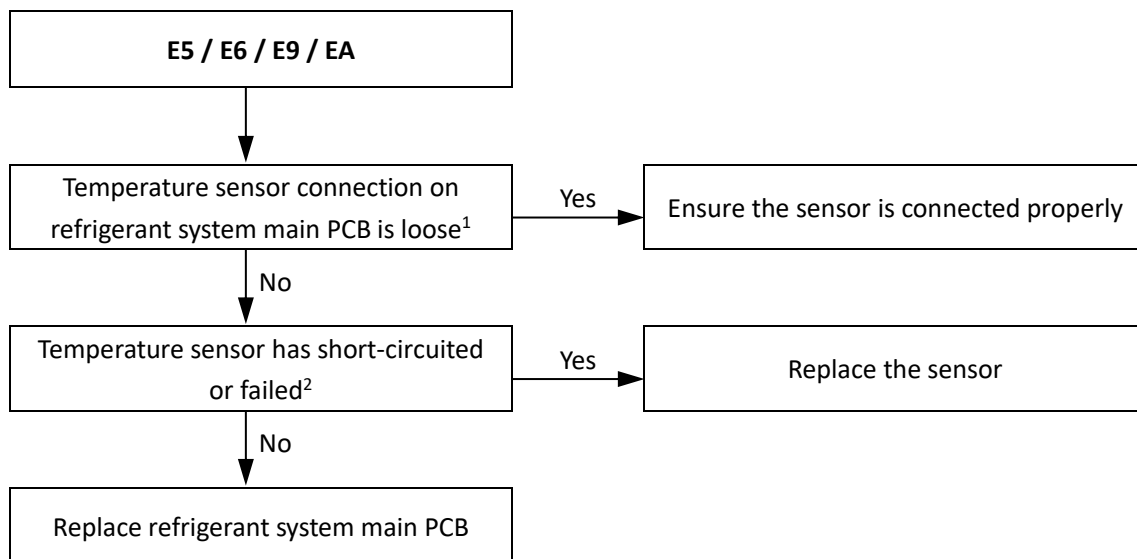

### Notes:

1. Air side heat exchanger refrigerant outlet temperature sensor and outdoor ambient temperature sensor connections are port CN9 on the HOP4(6,8,10)WMONO outdoor unit refrigerant system main PCB (labeled 12 in Figure 4-2.2 in Part 4, 2.1 “Main PCBs for Refrigerant System, Inverter Module”), port CN9 on the HOP12(14,16)WMONO outdoor unit refrigerant system main PCB (labeled 12 in Figure 4-2.3 in Part 4, 2.1 “Main PCBs for Refrigerant System, Inverter Module”), port CN9 on the HOP12(14,16)WMONO3 outdoor unit refrigerant system main PCB (labeled 17 in Figure 4-2.4 in Part 4, 2.1 “Main PCBs for Refrigerant System, Inverter Module”). Discharge pipe temperature sensor connection are port CN8 on the HOP4(6,8,10)WMONO outdoor unit refrigerant system main PCB (labeled 15 in Figure 4-2.2 in Part 4, 2.1 “Main PCBs for Refrigerant System, Inverter Module”), port CN8 on the HOP12(14,16)WMONO outdoor unit refrigerant system main PCB (labeled 15 in Figure 4-2.3 in Part 4, 2.1 “Main PCBs for Refrigerant System, Inverter Module”), port CN4 on the HOP12(14,16)WMONO3 outdoor unit refrigerant system main PCB (labeled 15 in Figure 4-2.4 in Part 4, 2.1 “Main PCBs for Refrigerant System, Inverter Module”). Suction pipe temperature sensor connection are port CN1 on the HOP4(6,8,10)WMONO outdoor unit refrigerant system main PCB (labeled 14 in Figure 4-2.2 in Part 4, 2.1 “Main PCBs for Refrigerant System, Inverter Module”), port CN1 on the HOP12(14,16)WMONO outdoor unit refrigerant system main PCB (labeled 14 in Figure 4-2.3 in Part 4, 2.1 “Main PCBs for Refrigerant System, Inverter Module”), port CN8 on the HOP12(14,16)WMONO3 outdoor unit refrigerant system main PCB (labeled 16 in Figure 4-2.4 in Part 4, 2.1 “Main PCBs for Refrigerant System, Inverter Module”).
2. Measure sensor resistance. If the resistance is too low, the sensor has short-circuited. If the resistance is not consistent with the sensor’s resistance characteristics table, the sensor has failed. Refer to Table 4-5.1, and Table 4-5.2 in Part 4, 5.1 “Temperature Sensor Resistance Characteristics”

## 4.7 EE Troubleshooting

### 4.7.1 Digital display output



### 4.7.2 Description

- Hydronic system EEPROM error.
- OPTIMUS PRO Mono stops running.
- Error code is displayed on hydronic system main control board for refrigerant system and user interface.

### 4.7.3 Possible causes

- Hydronic system main PCB EEPROM is not connected properly.
- Hydronic system main PCB damaged.

### 4.7.4 Procedure

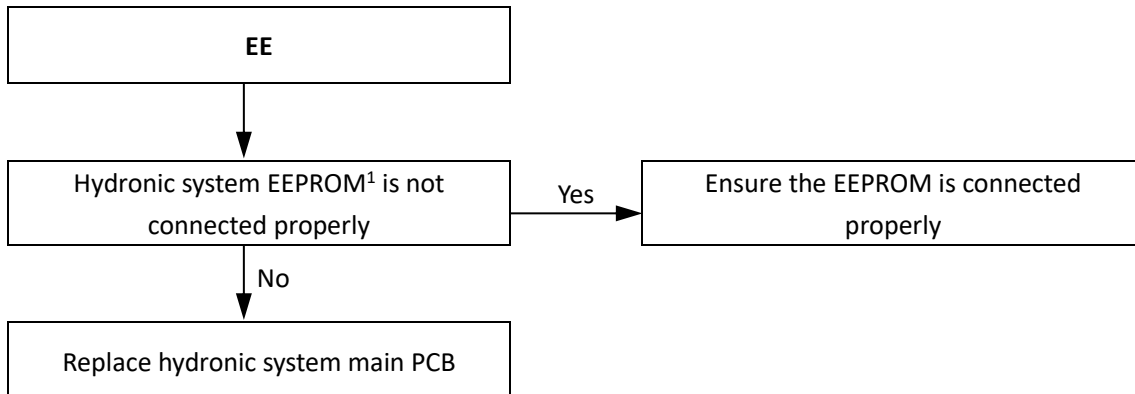

#### Notes:

1. Hydronic system main PCB EEPROM is designated IC18 on the hydronic system main PCB (labeled 29 in Figure 4-2.1 in Part 4, 2.2 "Main PCB for Hydronic System").

# OPTIMUS PRO Mono

## 4.8 F1 Troubleshooting

### 4.8.1 Digital display output



### 4.8.2 Description

- Low DC bus voltage.
- OPTIMUS PRO Mono stops running.
- Error code is displayed on hydronic system main control board for refrigerant system and user interface.

### 4.8.3 Possible causes

- The DC bus voltage is too low.

### 4.8.4 Procedure

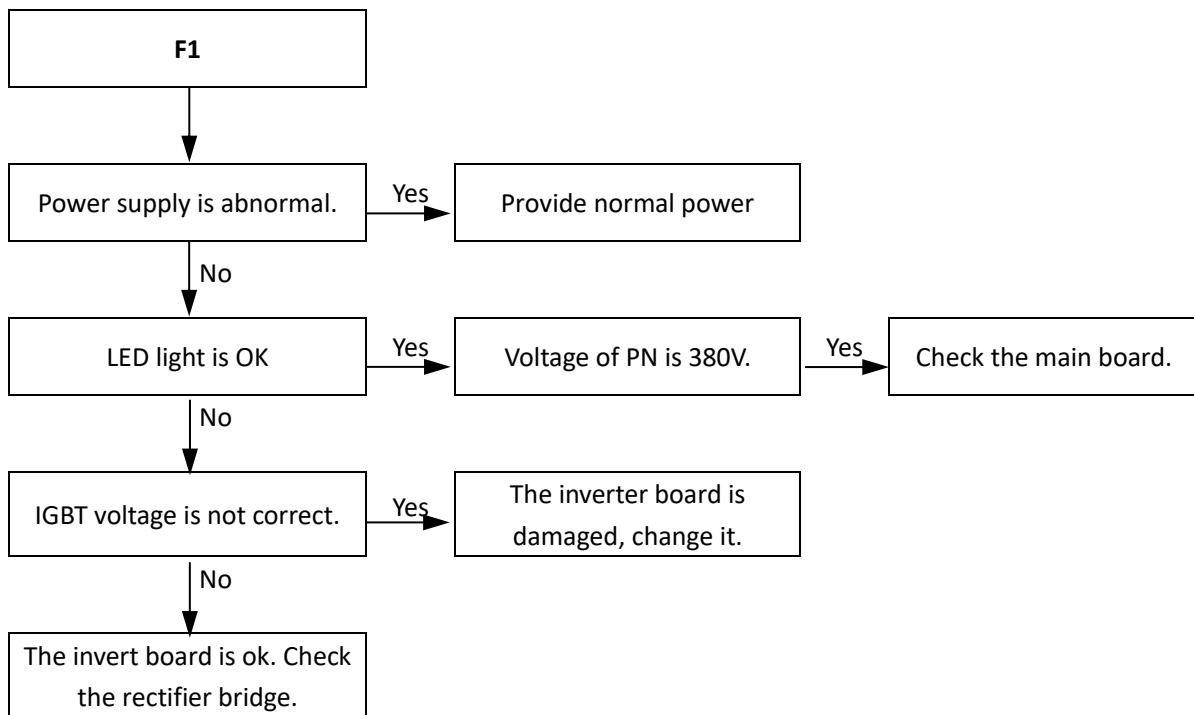

## 4.9 HF Troubleshooting

### 4.9.1 Digital display output



### 4.9.2 Description

- Refrigerant system EEPROM error.
- OPTIMUS PRO Mono stops running.
- Error code is displayed on refrigerant system main control board for refrigerant system and user interface.

### 4.9.3 Possible causes

- Refrigerant system main PCB EEPROM is not connected properly.
- Refrigerant system main PCB damaged.

### 4.9.4 Procedure

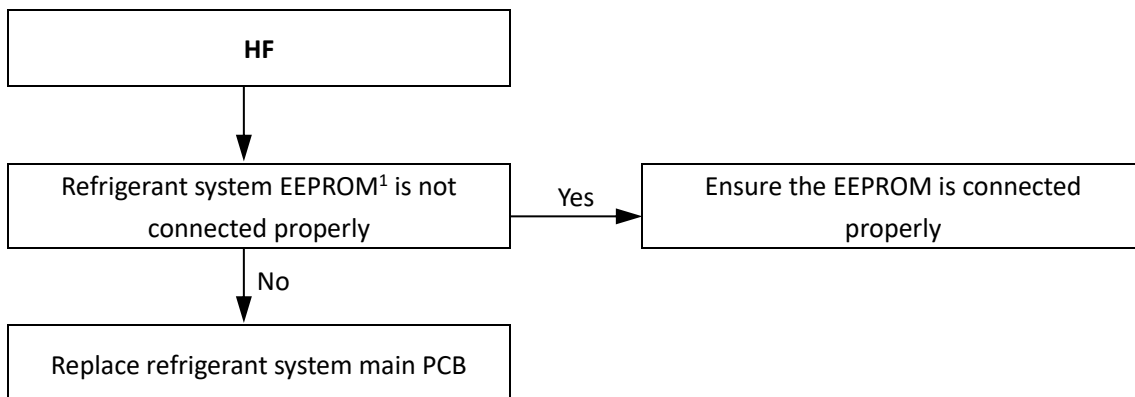

#### Notes:

1. Refrigerant system main PCB EEPROM is designated IC23 on the refrigerant system main PCBs (labeled 29 in Figure 4-2.2 in Part 4, 2.3 “Main PCBs for Refrigerant System, Inverter Modules and Filter Boards”), designed IC13 on the refrigerant system main PCBs (labeled 19 in Figure 4-2.4 in Part 4, 2.2 “Main PCBs for Refrigerant System, Inverter Modules and Filter Boards”), designed IC23 on the refrigerant system main PCBs (labeled 26 in Figure 4-2.6 in Part 4, 2.2 “Main PCBs for Refrigerant System, Inverter Modules and Filter Boards”).

# OPTIMUS PRO Mono

## 4.10 H0 Troubleshooting

### 4.10.1 Digital display output



### 4.10.2 Description

- Communication error between refrigerant system main control chip and hydronic system main control chip.
- OPTIMUS PRO Mono stops running.
- Error code is displayed on hydronic system main PCB, refrigerant system main control board for refrigerant system and user interface.

### 4.10.3 Possible causes

- Power supply abnormal.
- Transformer malfunction.
- Interference from a source of electromagnetic radiation.
- Refrigerant system main PCB or hydronic system main PCB damaged.

### 4.10.4 Procedure

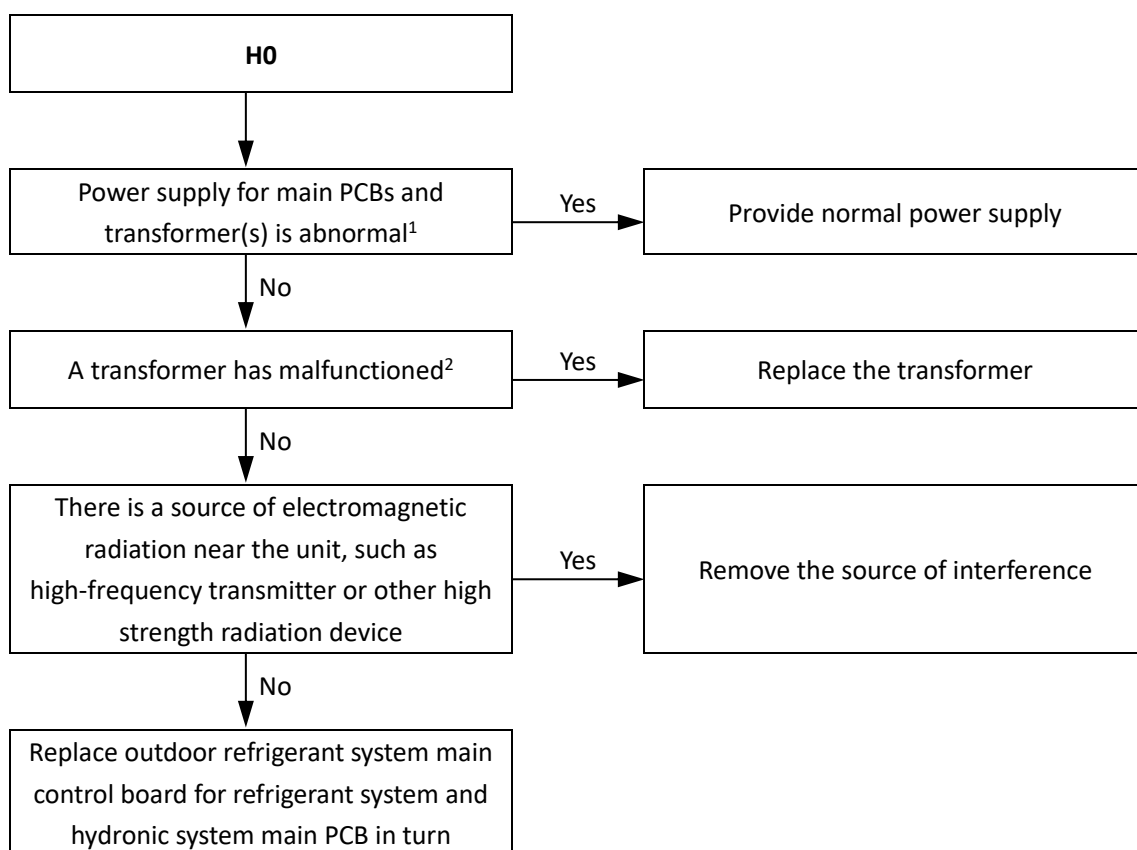

#### Notes:

1. Measure the voltages of transformer(s) input port and on the main PCB. The normal voltage between transformer input port terminals is 220V, between GND and 18V is 18V. If one or more of the voltages are not normal, the power supply for main control board for refrigerant system and transformer is abnormal.
2. Measure the voltages of transformer(s) output ports. If the voltages are not normal, the transformer has malfunctioned.

## 4.11 H1 Troubleshooting

### 4.11.1 Digital display output



#### 4.11.2 Description

- Communication error between refrigerant system main control chip and the inverter driver chip.
- OPTIMUS PRO Mono stops running.
- Error code H1 is displayed on refrigerant system main control board and user interface.

#### 4.11.3 Possible causes

- Power supply abnormal.
- Transformer malfunction.
- Interference from a source of electromagnetic radiation.
- Refrigerant system main PCB or inverter driven module damaged.

#### 4.11.4 Procedure

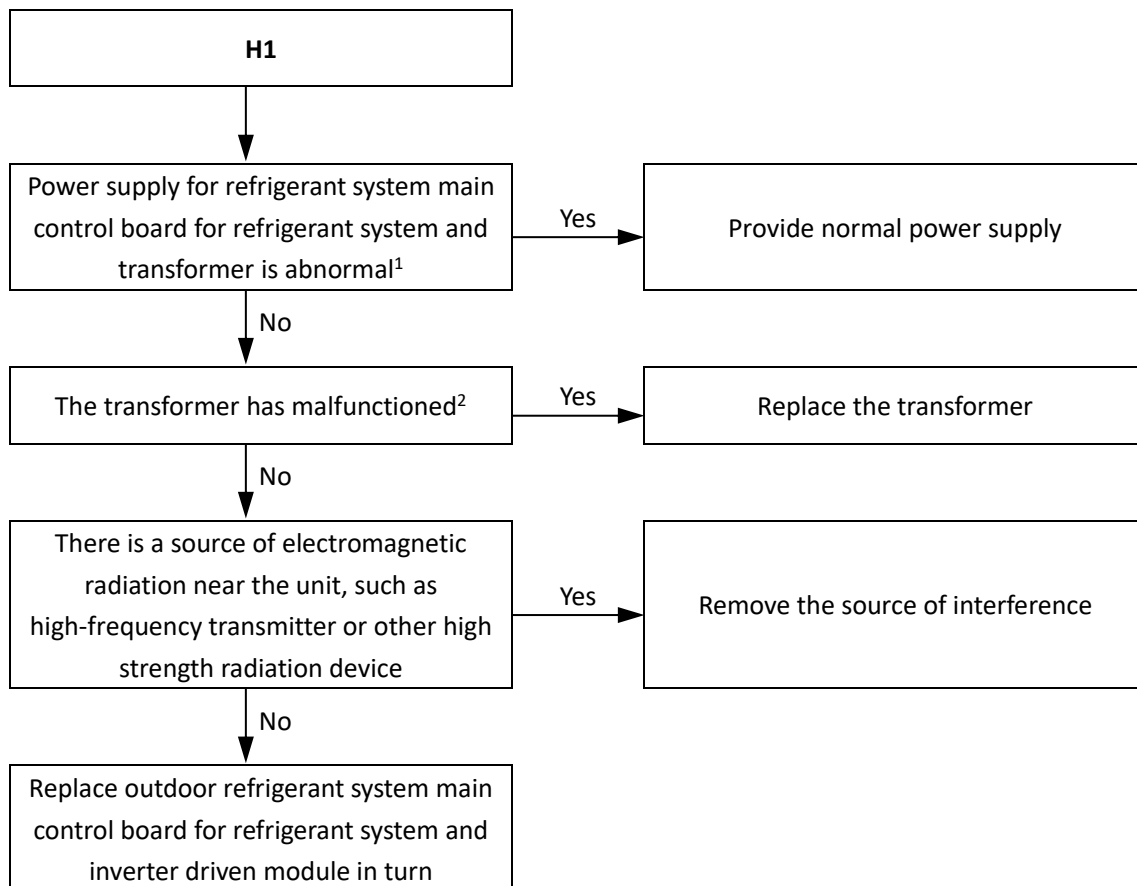

#### Notes:

1. Measure the voltages of transformer input port and on the main PCB. The normal voltage between transformer input port terminals is 220V, output two sets of voltages 11V and 17V. If one or more of the voltages are not normal, the power supply for main control board for refrigerant system and transformer is abnormal.
2. Measure the voltages of transformer output ports. If the voltages are not normal, the transformer has malfunctioned.



# OPTIMUS PRO Mono

## 4.12 H6, HH Troubleshooting

### 4.12.1 Digital display output

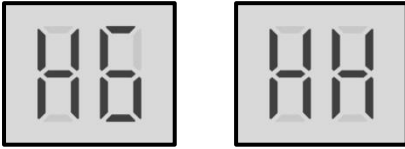

### 4.12.2 Description

- H6 indicates a DC fan error.
- HH indicates that H6 protection has occurred 10 times in 2 hours. When an HH error occurs, a manual system restart is required before the system can resume operation. The cause of an HH error should be addressed promptly in order to avoid system damage.
- OPTIMUS PRO Mono stops running.
- Error code is displayed on refrigerant system main control board for refrigerant system and user interface.

### 4.12.3 Possible causes

- Power or communication wires not connected properly.
- High wind speed.
- Fan motor blocked or has failed.
- Power supply abnormal.
- PFC module damaged.
- IPM module damaged.
- Main PCB damaged.

## 4.12.4 Procedure

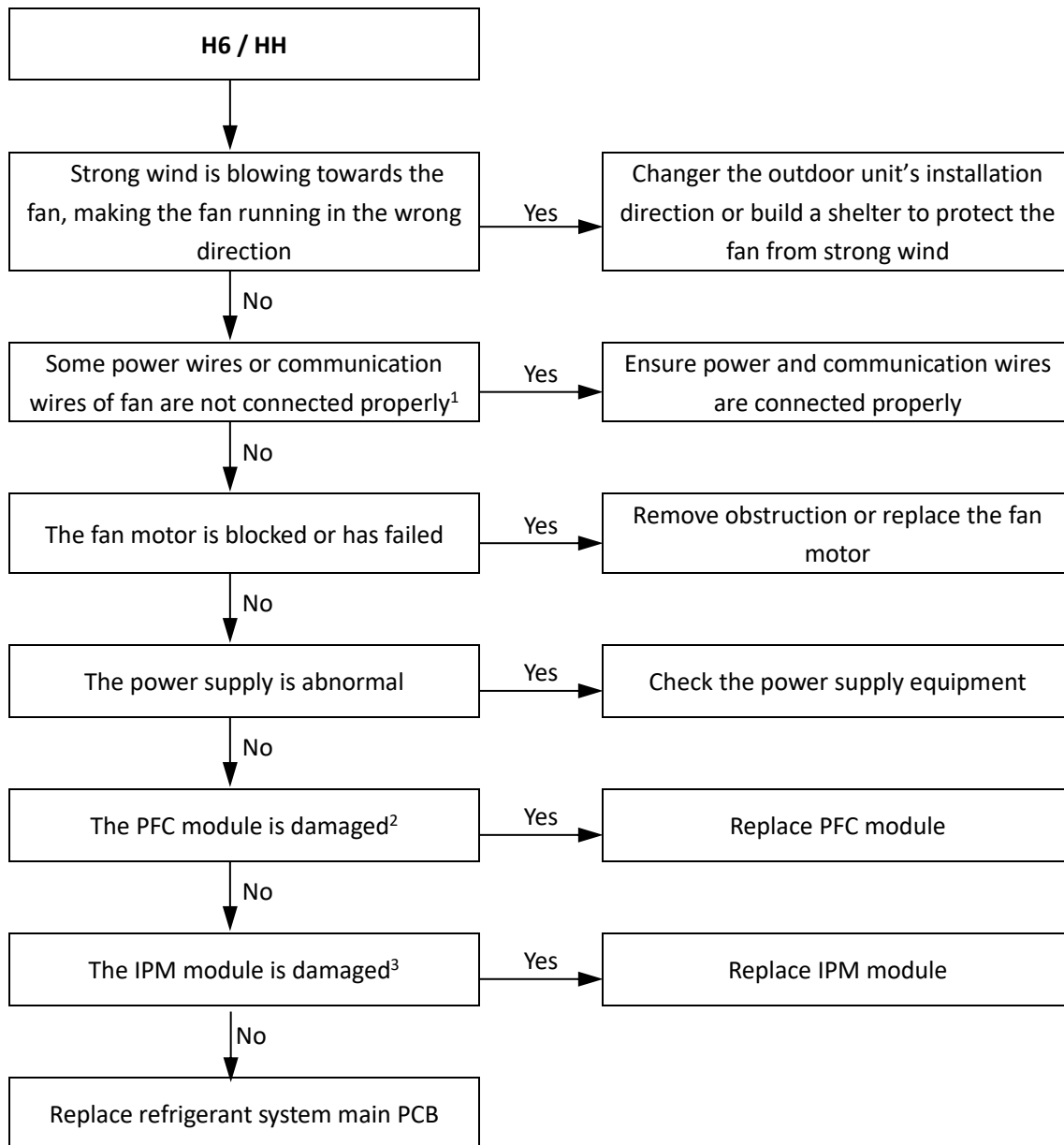

## Notes:

1. Refer to Figures 4-1.1 to 4-1.7 in Part 4, 1 "Outdoor Unit Electric Control Box Layout" and to the OPTIMUS PRO Mono Engineering Data Book, Part 2, 5 "Wiring Diagrams".
2. Only applies to single-phase power supply models. Check the voltage between "+" and "-" terminals on the PFC module on the inverter module. The normal range is 277V to 354V. If the voltage is outside this range, the PFC module is damaged.
3. Measure the voltage between the DC fan motor power supply's white and black wires. The normal voltage is 15V when the unit is in standby. If the voltage is significantly different from 15V, the IPM module on the inverter module is damaged. The fan connections on each type of refrigerant system main control board for refrigerant systemre labelled in Figures 4-2.2, 4-2.4 and 4-2.6 in Part 4, 2.3 "Main PCBs for Refrigerant System, Inverter Modules and Filter Boards".

## OPTIMUS PRO Mono

### 4.13 H7 Troubleshooting

#### 4.13.1 Digital display output



#### 4.13.2 Description

- Abnormal main circuit voltage.
- OPTIMUS PRO Mono stops running.
- Error code is displayed on refrigerant system main control board for refrigerant system and user interface.

#### 4.13.3 Possible causes

- Power supply voltage not within  $\pm 10\%$  of rated voltage or a phase is missing.
- Outdoor unit powered on immediately after being powered off.
- Loosened wiring within electric control box.
- High voltage circuit error.
- Main PCB damaged.

## 4.13.4 Procedure

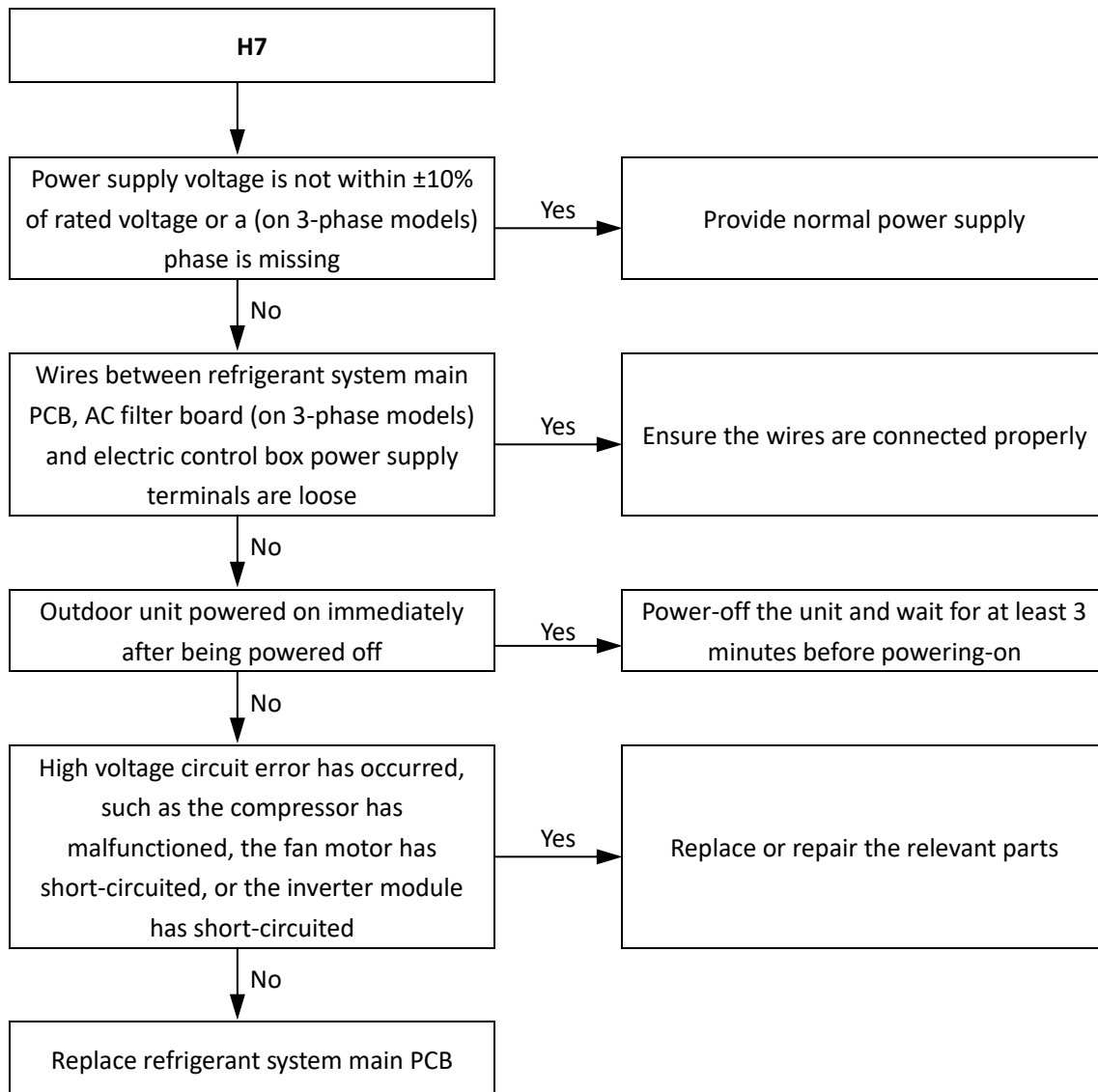

# OPTIMUS PRO Mono

## 4.14 H8 Troubleshooting

### 4.14.1 Digital display output



### 4.14.2 Description

- Pressure sensor error.
- OPTIMUS PRO Mono stops running.
- Error code is displayed on refrigerant system main control board for refrigerant system and user interface.

### 4.14.3 Possible causes

- Pressure sensor not connected properly or has malfunctioned.
- Refrigerant system main PCB damaged.

### 4.14.4 Procedure

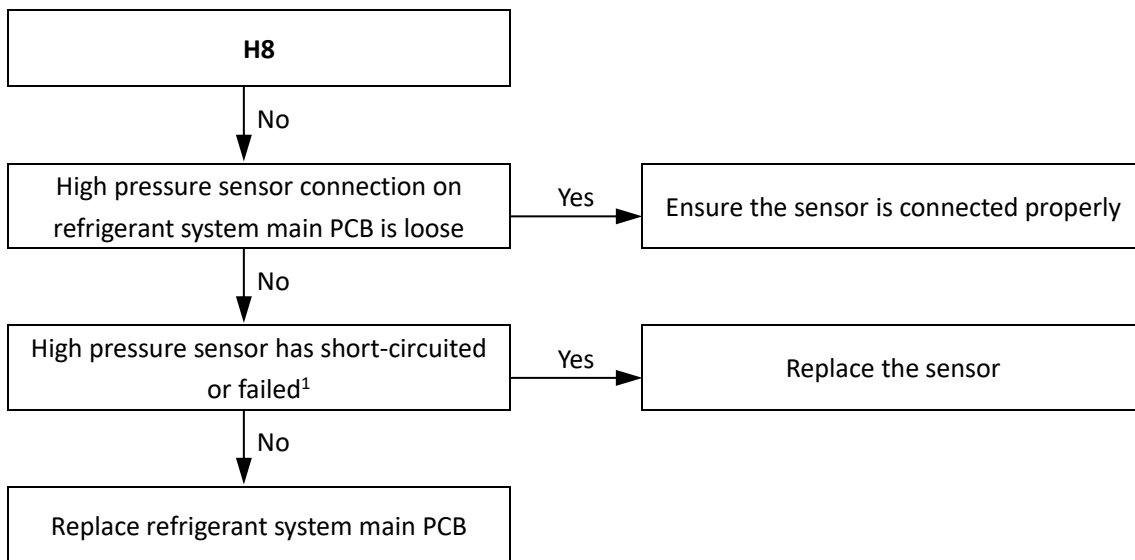

#### Notes:

1. Measure the resistance among the three terminals of the pressure sensor. If the resistance is of the order of mega Ohms or infinite, the pressure sensor has failed. The pressure sensor connection on each type of refrigerant system main PCB is labelled in Figures 4-2.2, 4-2.4 and 4-2.6 in Part 4, 2.3 "Main PCBs for Refrigerant System, Inverter Modules and Filter Boards". Refer also to Part 2, 1 "Layout of Functional Components".

## 4.15 P0, HP Troubleshooting

### 4.15.1 Digital display output

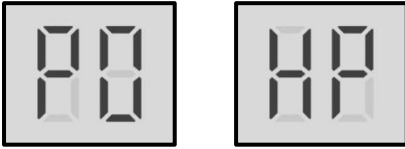

### 4.15.2 Description

- P0 indicates suction pipe low pressure protection. When the suction pressure falls below 0.14MPa, the system displays P0 protection and OPTIMUS PRO Mono stops running. When the pressure rises above 0.30MPa, P0 is removed and normal operation resumes.
- HP indicates P0 protection has occurred 3 times in 60 minutes. When an HP error occurs, a manual system restart is required before the system can resume operation.
- Error code is displayed on refrigerant system main control board for refrigerant system and user interface.

### 4.15.3 Possible causes

- Low pressure switch not connected properly or has malfunctioned.
- Insufficient refrigerant.
- Low pressure side blockage.
- Poor evaporator heat exchange in heating mode or DHW mode.
- Insufficient water flow in cooling mode.
- Main PCB damaged.

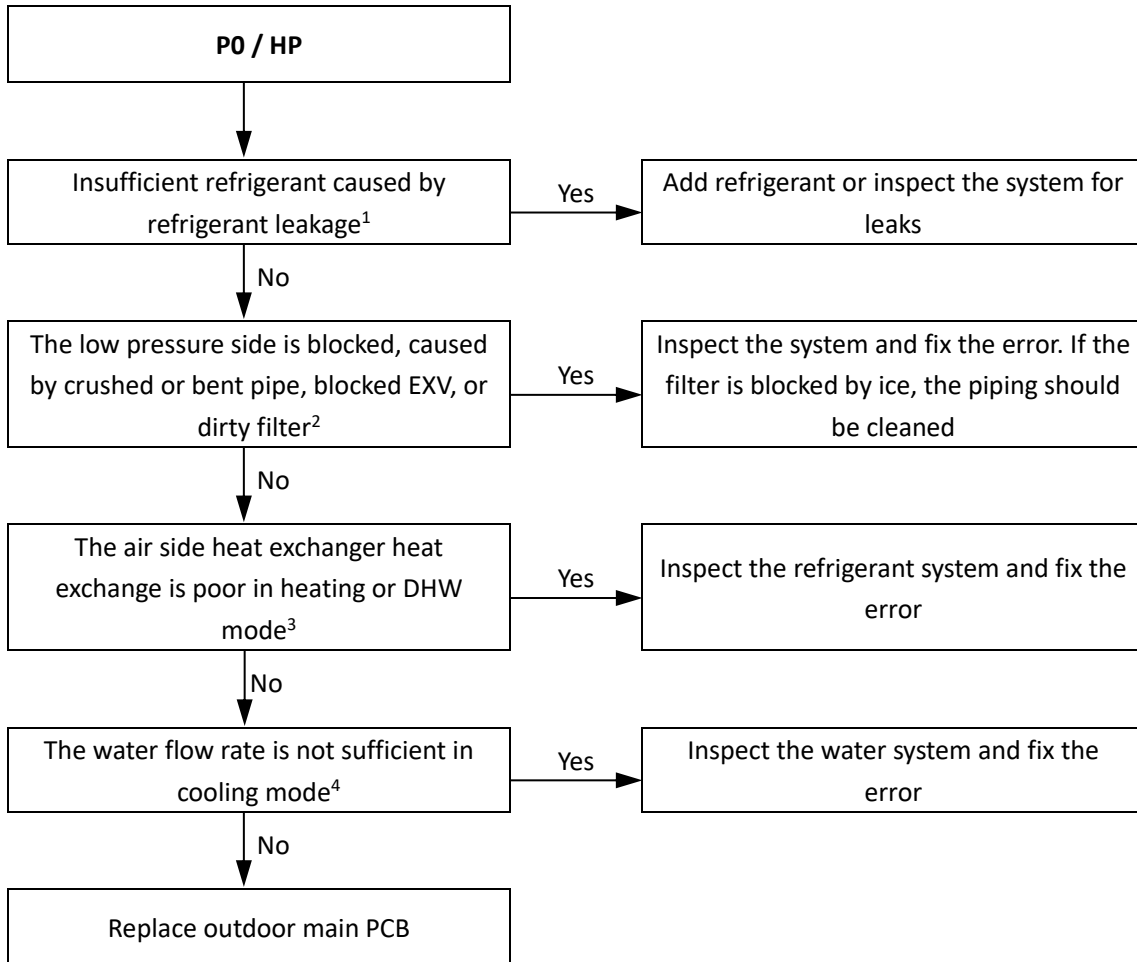

Notes:

1. To check for insufficient refrigerant:
  - An insufficiency of refrigerant causes compressor discharge temperature to be higher than normal, discharge and suction pressures to be lower than normal and compressor current to be lower than normal, and may cause frosting to occur on the suction pipe. These issues disappear once sufficient refrigerant has been charged into the system.
2. A low pressure side blockage causes compressor discharge temperature to be higher than normal, suction pressure to be lower than normal and compressor current to be lower than normal, and may cause frosting to occur on the suction pipe. For normal system parameters.
3. Check air side heat exchanger, fan(s) and air outlets for dirt/blockages.
4. Check water side heat exchanger, water piping, circulator pumps and water flow switch for dirt/blockages.

## 4.16 P1 Troubleshooting

### 4.16.1 Digital display output



### 4.16.2 Description

- Discharge pipe high pressure protection. When the discharge pressure rises above 4.2MPa, the system displays P1 protection and OPTIMUS PRO Mono stops running. When the discharge pressure falls below 3.2MPa, P1 is removed and normal operation resumes.
- Error code is displayed on refrigerant system main control board for refrigerant system and user interface.

### 4.16.3 Possible causes

- Pressure sensor/switch not connected properly or has malfunctioned.
- Excess refrigerant.
- System contains air or nitrogen.
- High pressure side blockage.
- Poor condenser heat exchange.
- Main PCB damaged.



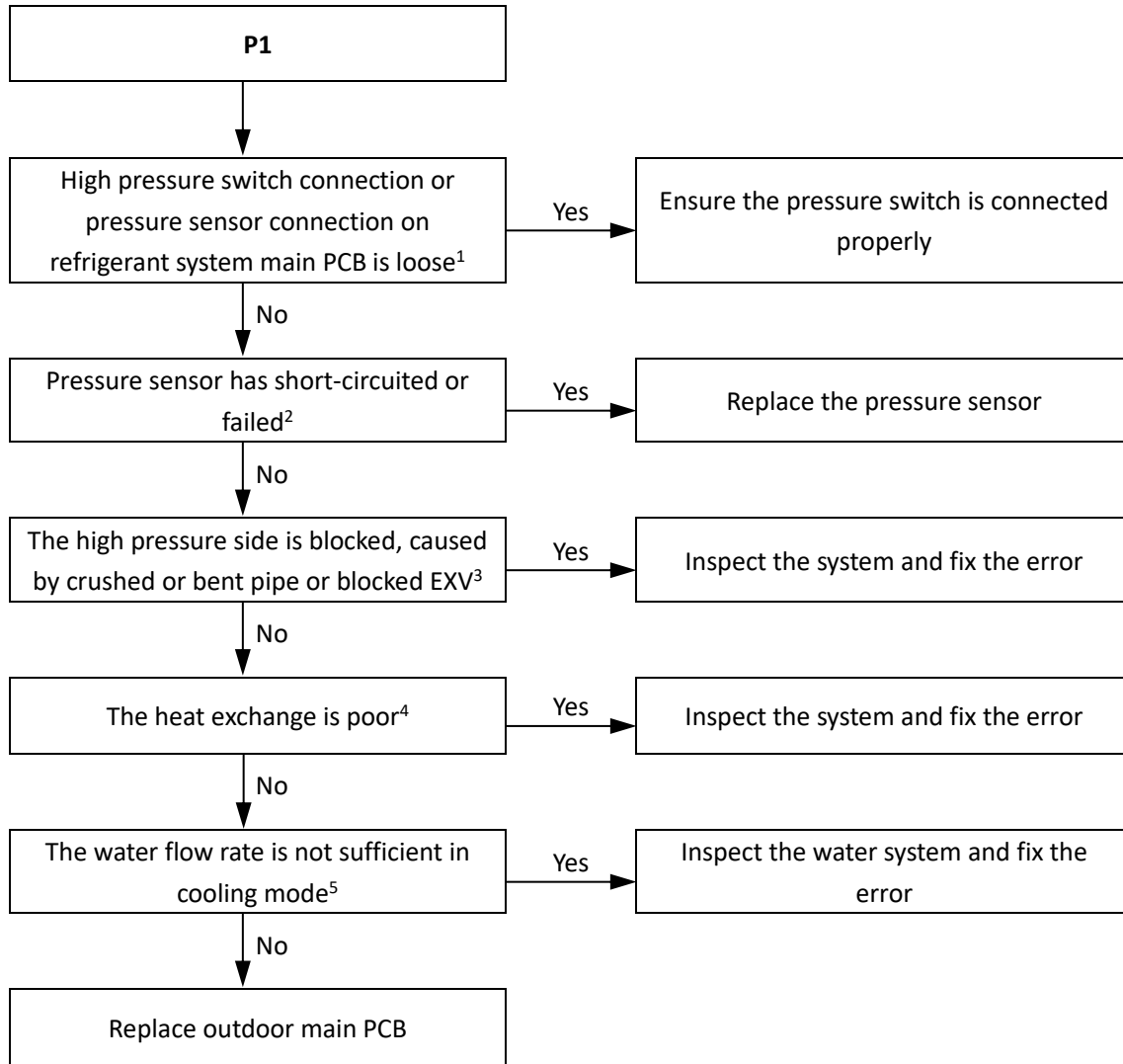

Notes:

1. High pressure switch connection is port CN13 on the HOP4(6,8,10)WMONO outdoor unit refrigerant system main PCB (labeled 16 in Figure 4-2.2 in Part 4, 2.3 "Main PCB for Refrigerant System, Inverter Module"). port CN13 on the HOP12(14,16)WMONO outdoor unit refrigerant system main PCB (labeled 16 in Figure 4-2.3 in Part 4, 2. 3 "Main PCB for Refrigerant System, Inverter Module"), port CN31 on the HOP12(14,16)WMONO3 outdoor unit refrigerant system main PCB (labeled 20 in Figure 4-2.4 in Part 4, 2. 3 "Main PCB for Refrigerant System, Inverter Module").
2. Measure the resistance among the three terminals of the pressure sensor. If the resistance is of the order of mega Ohms or infinite, the pressure sensor has failed.
3. High pressure side blockage causes discharge temperature to be higher than normal, discharge pressure to be higher than normal and suction pressure to be lower than normal.
4. In heating mode check water side heat exchanger, water piping, circulator pumps and water flow switch for dirt/blockages. In cooling mode check air side heat exchanger, fan(s) and air outlets for dirt/blockages.
5. Check water pressure on the manometer. If the water pressure is not > 1 bar, water flow is insufficient. Refer to Figure 2-1.2 and 2-1.6 in Part 2, 1 "Layout of Functional Components".

## 4.17 P3 Troubleshooting

### 4.17.1 Digital display output



### 4.17.2 Description

- Compressor current protection.
- When the compressor current rises above the protection value (4/6kW models 18A, 8/10kW model 19A, 12/14/16kW single phase model 30A, 12/14/16kW three phase model 14A), the system displays P3 protection and OPTIMUS PRO Mono stops running. When the current returns to the normal range, P3 is removed and normal operation resumes.
- Error code is displayed on refrigerant system main control board for refrigerant system and user interface.

### 4.17.3 Possible causes

- Power supply abnormal.
- Poor condenser heat exchange.
- High pressure side blockage.
- Inverter module damaged.
- Compressor damaged.
- Main PCB damaged.

# OPTIMUS PRO Mono

## 4.17.4 Procedure

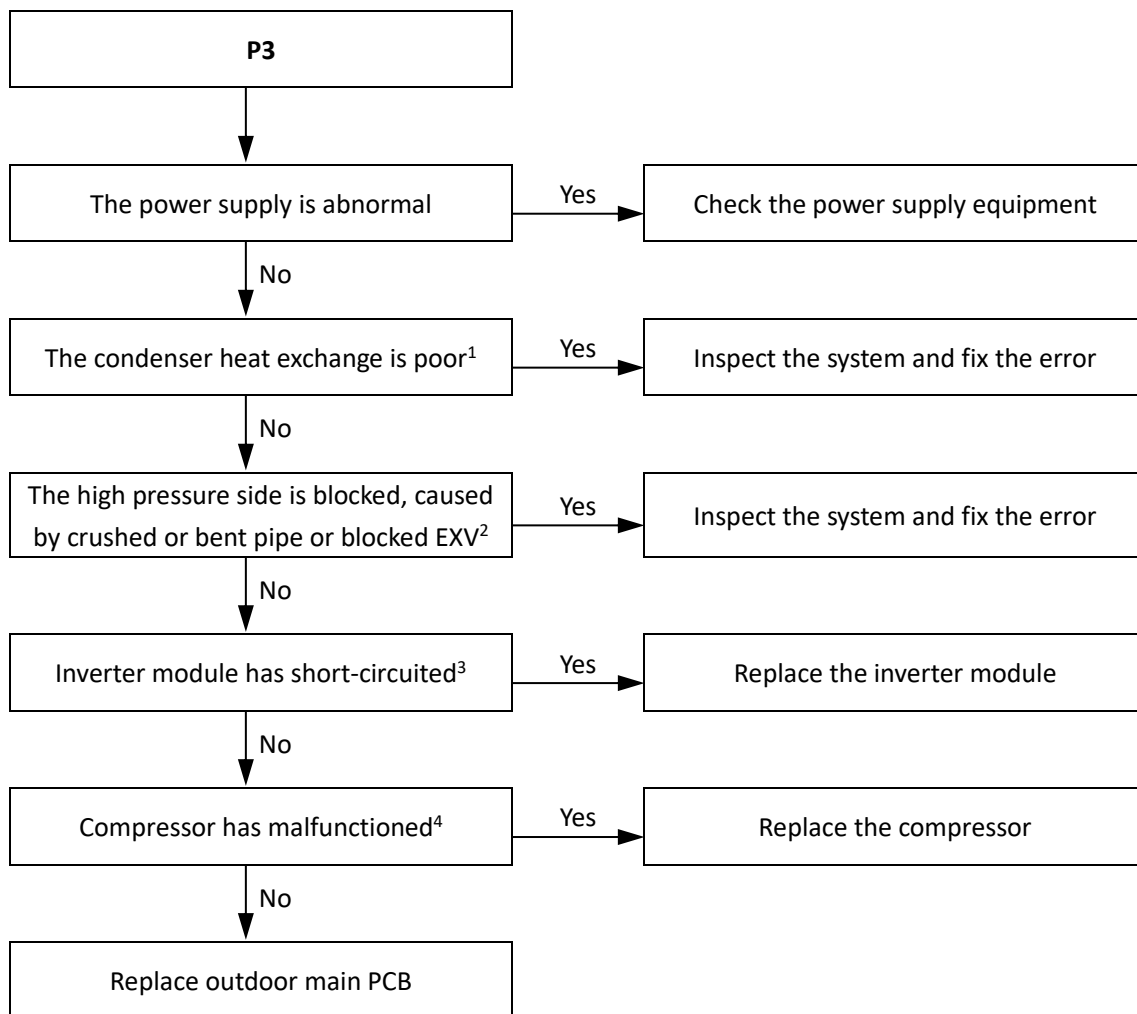

### Notes:

1. In heating mode check water side heat exchanger, water piping, circulator pumps and water flow switch for dirt/blockages. In cooling mode check air side heat exchanger, fan(s) and air outlets for dirt/blockages.
2. High pressure side blockage causes discharge temperature to be higher than normal, discharge pressure to be higher than normal and suction pressure to be lower than normal.
3. Set a multi-meter to buzzer mode and test any two terminals of P N and U V W of the inverter module. If the buzzer sounds, the inverter module has short-circuited.
4. The normal resistances of the inverter compressor are 0.7-1.5Ω among U V W and infinite between each of U V W and ground. If any of the resistances differ from these specifications, the compressor has malfunctioned.

## 4.18 P4 Troubleshooting

### 4.18.1 Digital display output



### 4.18.2 Description

- Discharge temperature protection.
- When the compressor the discharge temperature rises above 115°C, the system displays P4 protection and OPTIMUS PRO Mono stops running. When the discharge temperature falls below 95°C, P4 is removed and normal operation resumes.
- Error code is displayed on refrigerant system main control board for refrigerant system and user interface.

### 4.18.3 Possible causes

- Temperature sensor error
- High pressure side blockage.
- Poor condenser heat exchange.
- Main PCB damaged.

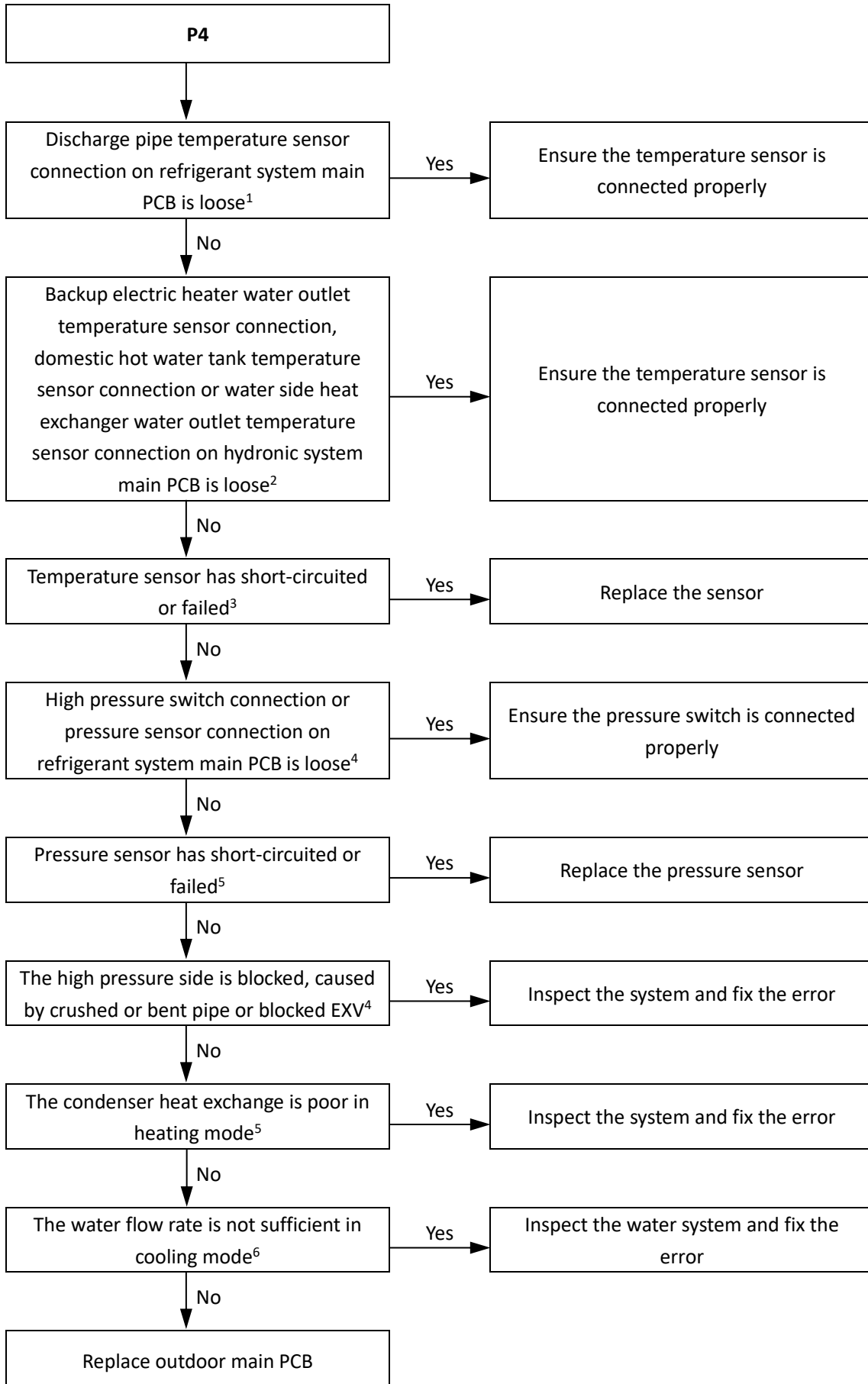

## Notes:

1. Discharge pipe temperature sensor connection is port CN8 on the HOP4(6,8,10)WMONO outdoor unit refrigerant system main PCB (labeled 15 in Figure 4-2.2 in Part4, 2.3 "Main PCB for Refrigerant System, Inverter Module"). port CN8 on the HOP12(14,16)WMONO outdoor unit refrigerant system main PCB (labeled 15 in Figure 4-2.3 in Part 4, 2. 3 "Main PCB for Refrigerant System, Inverter Module"), port CN4 on the HOP12(14,16)WMONO3 outdoor unit refrigerant system main PCB (labeled 15 in Figure 4-2.4 in Part 4, 2. 3 "Main PCB for Refrigerant System, Inverter Module").
2. Final outlet water temperature sensor and water side heat exchanger water outlet temperature sensor connections are port CN6 on the hydronic box main PCB (labeled 10 in Figure 4-2.1 in Part4, 2.2 "Main PCB for Hydronic System"). Domestic hot water tank temperature sensor connection is port CN13 on hydronic box main PCB (labeled 13 in Figure 4-2.1 in Part4, 2.2 "Main PCB for Hydronic System").
3. Measure sensor resistance. If the resistance is too low, the sensor has short-circuited. If the resistance is not consistent with the sensor's resistance characteristics table, the sensor has failed. Refer to Part 2, 1 "Layout of Functional Components" and to Table 5-5.1 or 5-5.2 in Part 5, 5.1 "Temperature Sensor Resistance Characteristics".
4. High pressure switch connection is port CN13 on the HOP4(6,8,10)WMONO outdoor unit refrigerant system main PCB (labeled 16 in Figure 4-2.2 in Part4, 2.3 "Main PCB for Refrigerant System, Inverter Module"). port CN13 on the HOP12(14,16)WMONO outdoor unit refrigerant system main PCB (labeled 16 in Figure 4-2.3 in Part 4, 2. 3 "Main PCB for Refrigerant System, Inverter Module"), port CN31 on the HOP12(14,16)WMONO3 outdoor unit refrigerant system main PCB (labeled 20 in Figure 4-2.4 in Part 4, 2. 3 "Main PCB for Refrigerant System, Inverter Module").
5. Measure the resistance among the three terminals of the pressure sensor. If the resistance is of the order of mega Ohms or infinite, the pressure sensor has failed.
6. High pressure side blockage causes discharge temperature to be higher than normal, discharge pressure to be higher than normal and suction pressure to be lower than normal.
7. Check air side heat exchanger, fan and air outlets for dirt/blockages.
8. Check the water side heat exchanger, water piping, circulator pumps and water flow switch for dirt/blockages.

## OPTIMUS PRO Mono

### 4.19 P5 Troubleshooting

#### 4.19.1 Digital display output



#### 4.19.2 Description

- High temperature difference between water side heat exchanger water inlet and water outlet temperatures protection.
- OPTIMUS PRO Mono stops running.
- Error code is displayed on hydronic system main control board for refrigerant system and user interface.

#### 4.19.3 Possible causes

- Temperature sensor not connected properly or has malfunctioned.
- Water piping contains air.
- Insufficient water flow.
- Hydronic system main PCB damaged.

## 4.19.4 Procedure

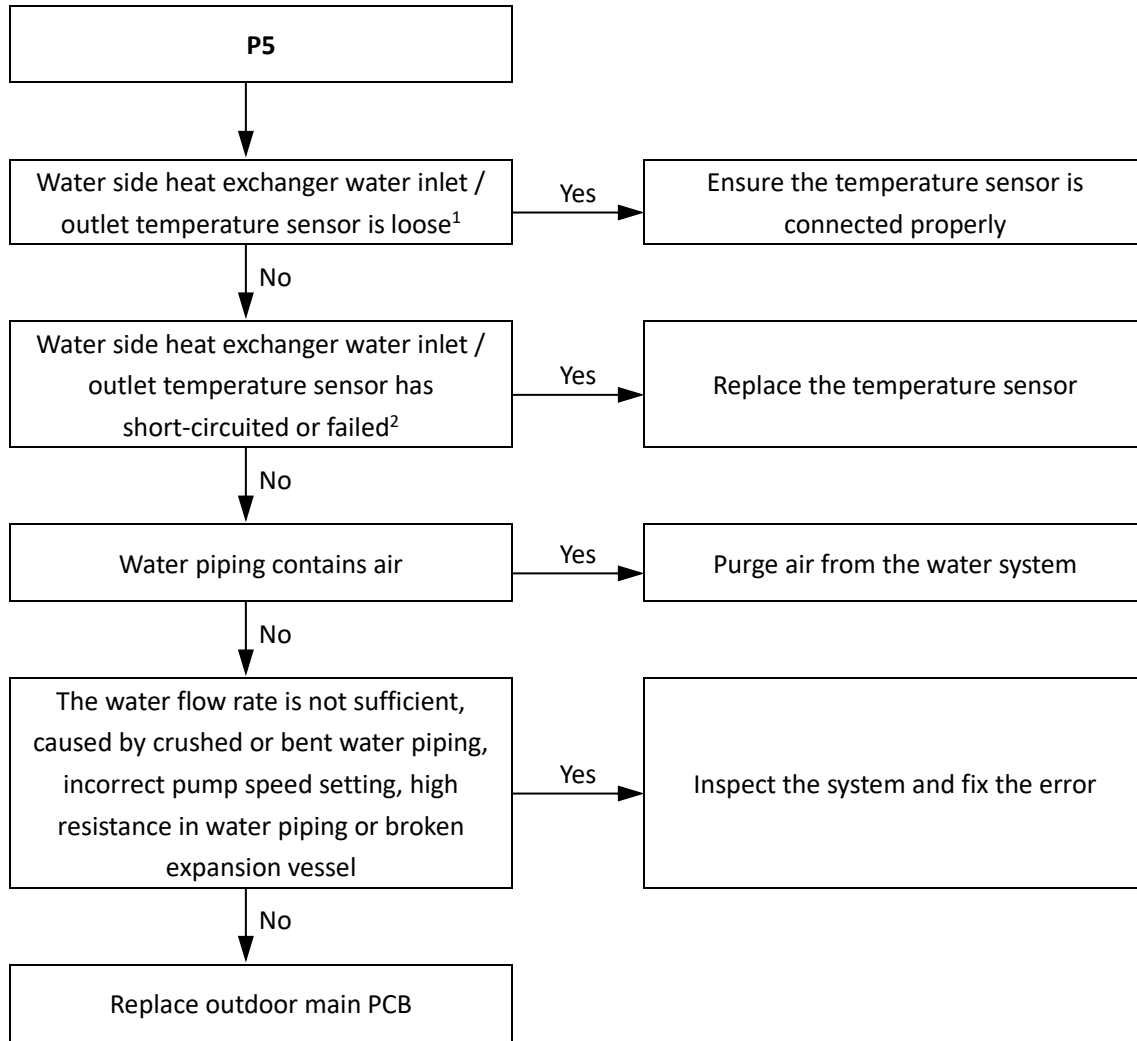

## Notes:

1. Water side heat exchanger water inlet temperature sensor and water side heat exchanger water outlet temperature sensor connections are port CN6 on the hydronic system main PCB (labeled 8 in Figure 4-2.1 in Part 4, 2.2 "Main PCB for Hydronic System").
2. Measure sensor resistance. If the resistance is too low, the sensor has short-circuited. If the resistance is not consistent with the sensor's resistance characteristics table, the sensor has failed. Refer to Part 2, 1 "Layout of Functional Components" and to Table 5-5.3 in Part 5, 5.1 "Temperature Sensor Resistance Characteristics".



# OPTIMUS PRO Mono

## 4.20 Inverter module Troubleshooting for single-phase models

### 4.20.1 Digital display output

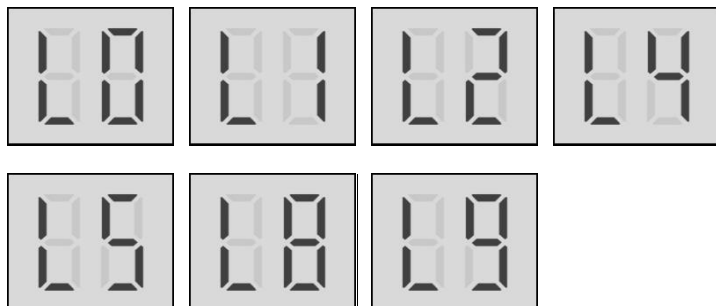

### 4.20.2 Description

- Inverter module protection.
- OPTIMUS PRO Split stops running.
- Specific error code L0, L1, L2, L4, L5, L8, L9 is displayed on the user interface and the main control board of refrigerant system.

### 4.20.3 Possible causes

- Inverter module protection.
- DC bus low or high voltage protection.
- MCE error(DC bus low or high voltage protection or software over current protection)
- Zero speed protection.
- Excessive compressor frequency variation.
- Actual compressor frequency differs from target frequency.
- High pressure protection.
- PED board self checking fail.

### 4.20.4 Specific error codes for inverter module protection

Table 4-4.1: Specific error codes

Specific error code	Content
L0	Inverter module protection
L1	DC bus low voltage protection
L2	DC bus high voltage protection
L4	MCE error(DC bus low or high voltage protection or software over current protection)
L5	Zero speed protection
L8	Compressor frequency variation greater than 15Hz within 1 second protection
L9	Actual compressor frequency differs from target frequency by more than 15Hz protection

The specific error codes can also be obtained from the LED indicators on the inverter module.

Table 4-4.2: Errors indicated on LED, single-phase 4~10kW

LED301 flashing pattern (GREEN) LED302 is always on (RED)	Corresponding error
Flashes 8 times and stops for 1 second, then repeats	L0 - Inverter module protection
Flashes 9 times and stops for 1 second, then repeats	L1 - DC bus low voltage protection
Flashes 10 times and stops for 1 second, then repeats	L2 - DC bus high voltage protection
Flashes 12 times and stops for 1 second, then repeats	L4 - MCE error
Flashes 13 times and stops for 1 second, then repeats	L5 - Zero speed protection
Flashes 16 times and stops for 1 second, then repeats	L8 - Compressor frequency variation greater than 15Hz within one second protection
Flashes 17 times and stops for 1 second, then repeats	L9 - Actual compressor frequency differs from target frequency by more than 15Hz protection

Table 4-4.3: Errors indicated on LED, single-phase 4~10kW

LED1 flashing pattern (GREEN) LED2 is always on (RED)	Corresponding error
Flashes 3 times and stops for 1 second, then repeats	P1 - High pressure protection
Flashes 5 times and stops for 1 second, then repeats	bH – PED board checking fail
Flashes 8 times and stops for 1 second, then repeats	L0 - Inverter module protection
Flashes 9 times and stops for 1 second, then repeats	L1 - DC bus low voltage protection
Flashes 10 times and stops for 1 second, then repeats	L2 - DC bus high voltage protection
Flashes 12 times and stops for 1 second, then repeats	L4 - MCE error
Flashes 13 times and stops for 1 second, then repeats	L5 - Zero speed protection
Flashes 16 times and stops for 1 second, then repeats	L8 - Compressor frequency variation greater than 15Hz within one second protection
Flashes 17 times and stops for 1 second, then repeats	L9 - Actual compressor frequency differs from target frequency by more than 15Hz protection

Figure 4-4.1: LED location of inverter module Inverter Module(4-10KW): LED301/302/303

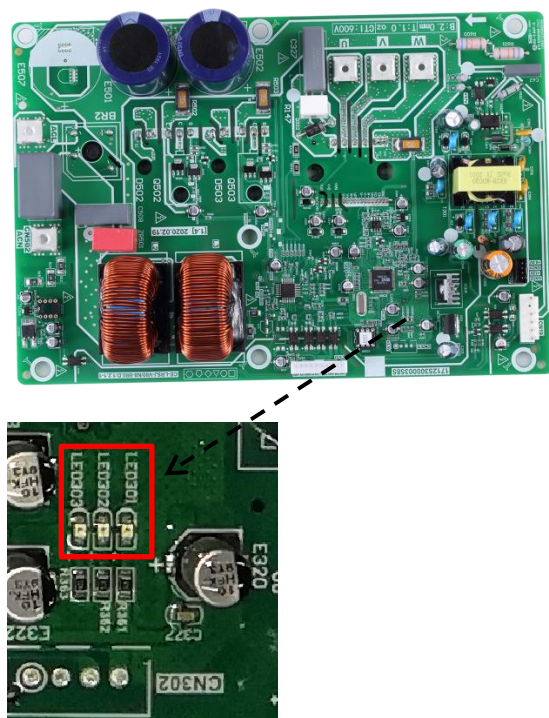

Inverter Module(12-16KW): LED1/LED2/LED3

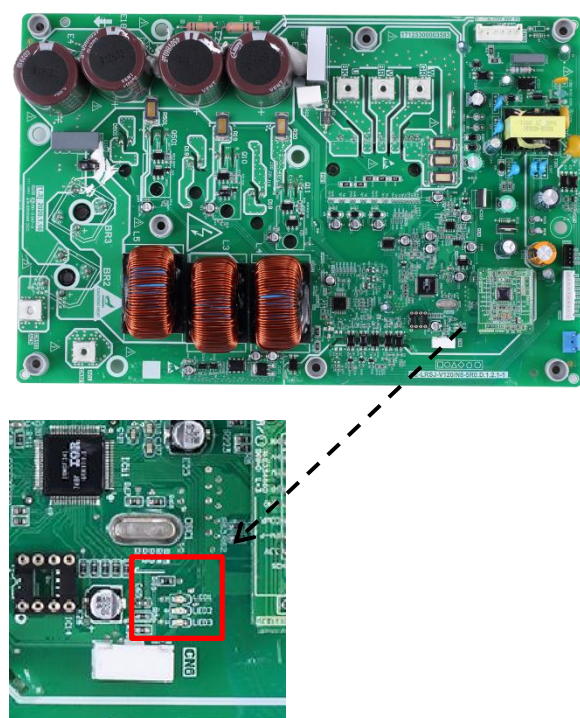

# OPTIMUS PRO Mono

## 4.20.5 Principle of DC inverter

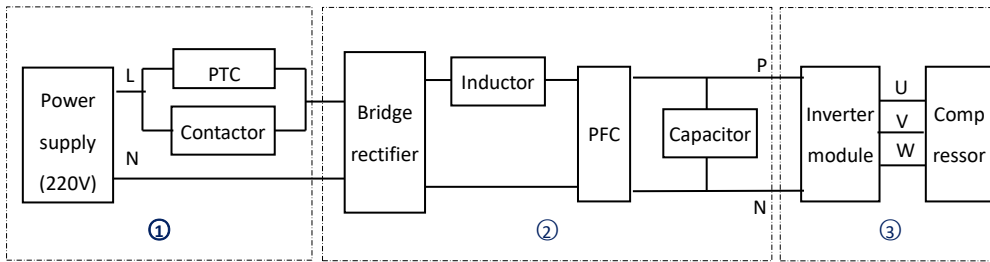

- ① Contactor is open, the current across the PTC to charge capacitor. After 5 seconds, the contactor closed.
- ② 220-240V AC power supply change to DC power supply after bridge rectifier.
- ③ The capacitor output steady power supply for inverter module P N terminals. In standby the voltage between P and N terminal on inverter module is 1.4 time of AC power supply. When the fan motor is running, the voltage is 377V DC.

## 4.20.6 L0/L4 troubleshooting

Situation 1: L0 or L4 error appears immediately after the outdoor unit is powered-on

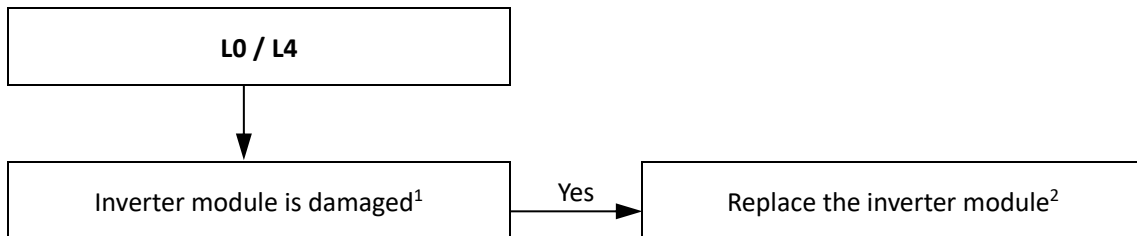

Notes:

1. Measure the resistance between each of U, V and W and each of P and N on the inverter module. All the resistances should be infinite. If any of them are not infinite, the inverter module is damaged and should be replaced. Refer to Figure 4-2.5 to 4-2.7 in Part 4, 2.1 "Main PCBs for Refrigerant System, Inverter Module".
2. When replacing an inverter module, a layer of thermally conductive silica gel should be painted on the IPM module, IGBT, diode, bridge rectifier (on the reverse side of the inverter module). Refer to Figure 4-4.2.

Figure 4-4.2: Replacing an inverter module

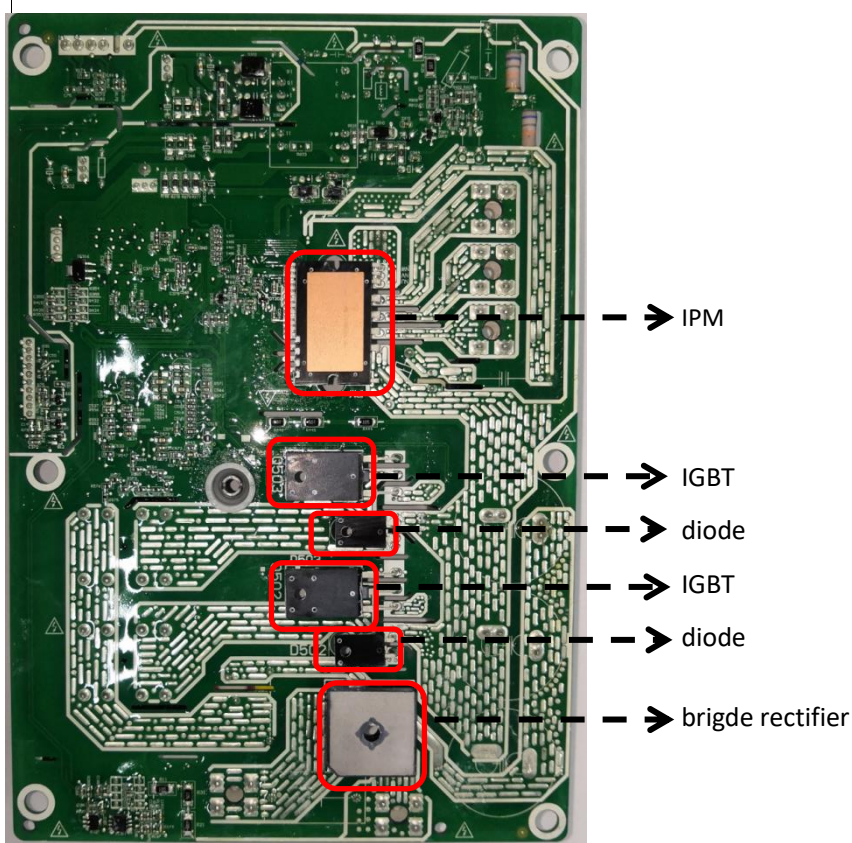

## Situation 2: L0 or L4 error appears immediately after the compressor starts up

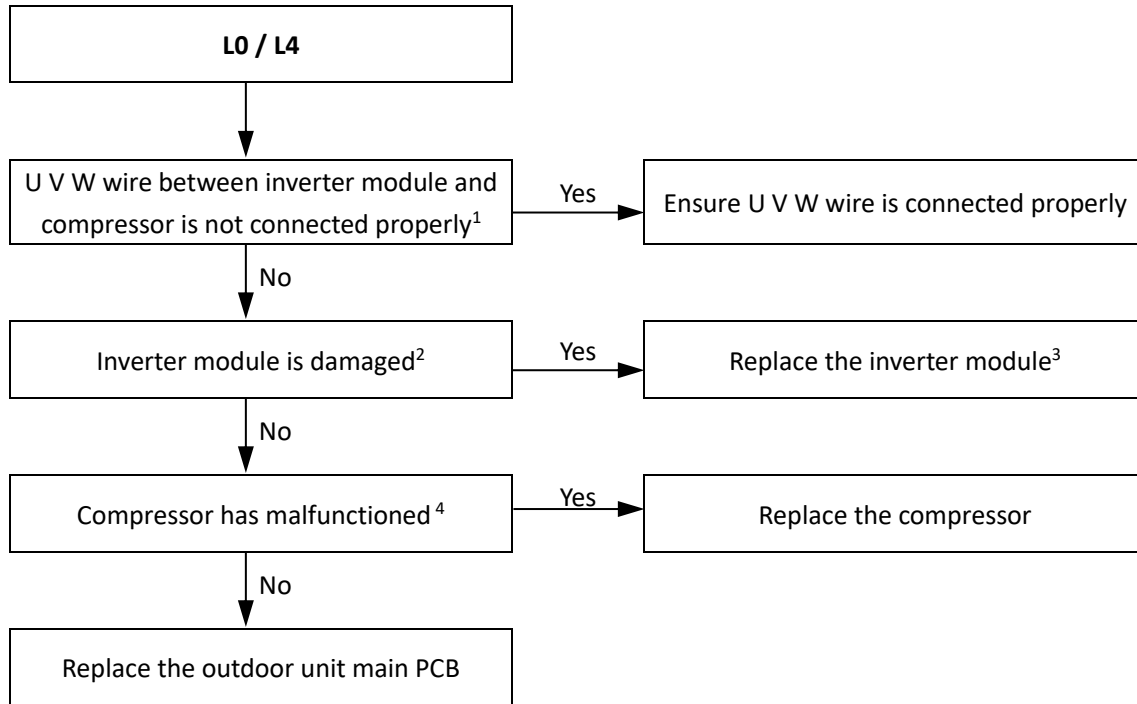

## Notes:

1. Connect the U V W wire from the inverter module to the correct compressor terminals, as indicated by the labels on the compressor.
2. Measure the resistance between each of U, V and W and each of P and N on the inverter module. All the resistances should be infinite. If any of them are not infinite, the inverter module is damaged and should be replaced. Refer to Figure 4-2.5 to 4-2.7 in Part 4, 2.1 "Main PCBs for Refrigerant System, Inverter Module".
3. When replacing an inverter module, a layer of thermally conductive silica gel should be painted on the IPM module, IGBT, diode bridge rectifier (on the reverse side of the inverter module PCB). Refer to Figure 4-4.2.
4. The normal resistances of the inverter compressor are 0.7-1.5Ω among U V W and infinite between each of U V W and ground. If any of the resistances differ from these specifications, the compressor has malfunctioned.

## OPTIMUS PRO Mono

Situation 3: L0 or L4 error appears after the compressor has been running for a period of time and the compressor speed is over 60rps

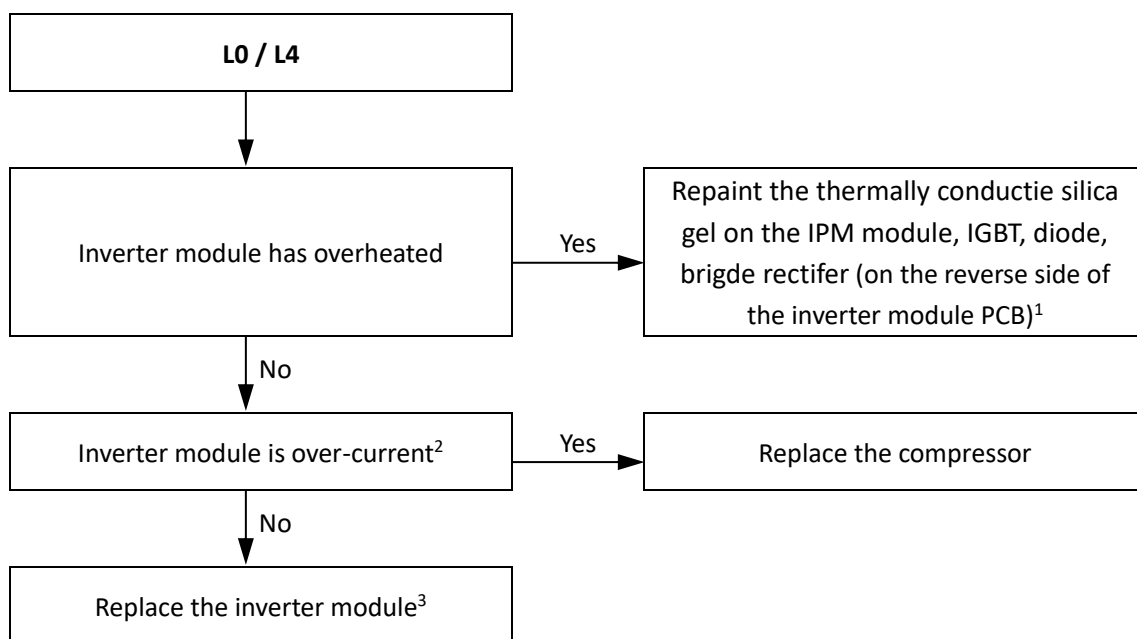

Notes:

1. Refer to Figure 4-4.2.
2. Use clip-on ammeter to measure the compressor current, if the current is normal indicates the inverter module is failed, if the current is abnormal indicates the compressor is failed.
3. When replacing an inverter module, a layer of thermally conductive silica gel should be painted on the PFC and IPM modules (on the reverse side of the inverter module PCB). Refer to Figure 4-4.2.

Situation 4: L0 error appears occasionally/irregularly

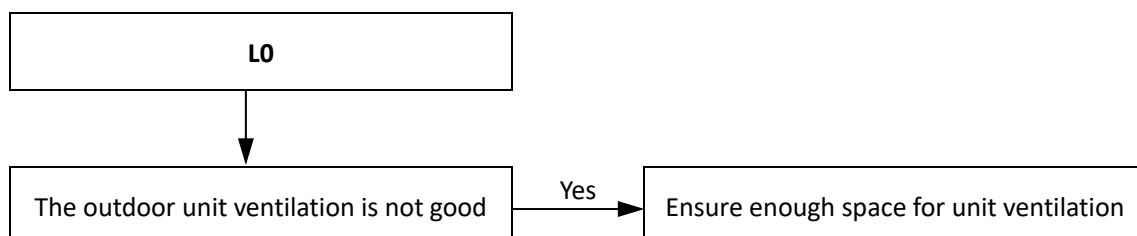



4.20.7 L1/L2 troubleshooting

The normal DC voltage between terminals P and N on inverter module is 1.4 time of AC power supply in standby , the DC voltage is 377V when the fan motor is running. If the voltage is lower than 160V, the unit displays L1. If the voltage is higher than 500V, the unit display L2.

Figure 4-4.3: Inverter module terminals

Inverter module terminals (4-10KW)

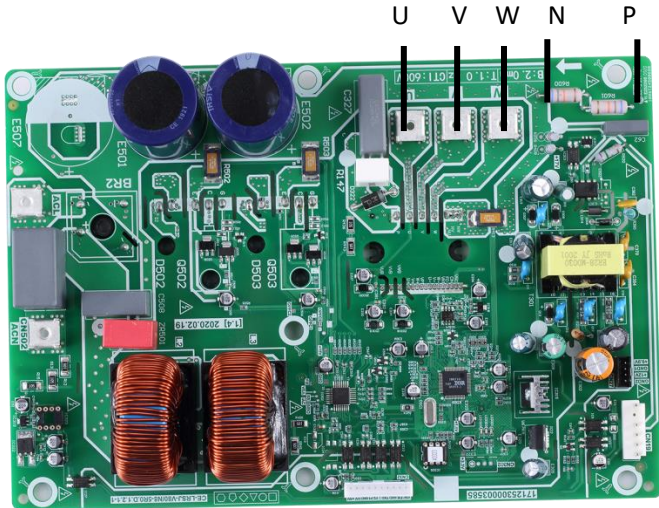

Inverter module terminals (12-16KW)

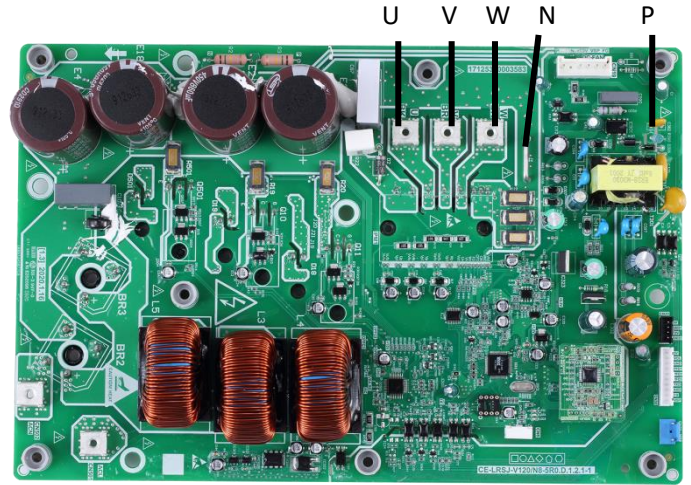

Situation 1: L1 or L2 error appears immediately after the outdoor unit is powered-on

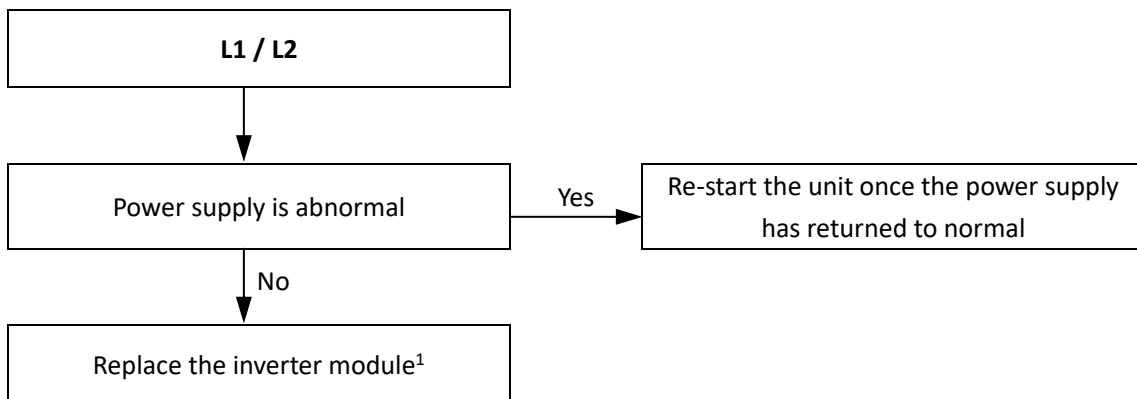

- Notes:
1. When replacing an inverter module, a layer of thermally conductive silica gel should be painted on the IPM module, IGBT, diode, bridge rectifier (on the reverse side of the inverter module PCB). Refer to Figure 4-4.2.

Situation 2: L1 or L2 error appears after the compressor has been running for a period of time and the compressor speed is over 20rps

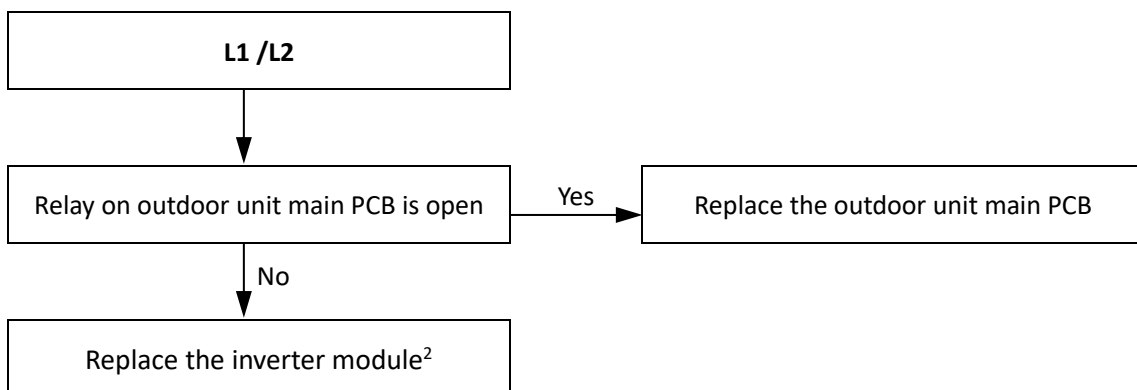

# OPTIMUS PRO Mono

Notes:

1. If the fan motor is running and the DC voltage between terminals P and N on inverter module declined, Relay on the main control board of outdoor unit is open.
2. When replacing an inverter module, a layer of thermally conductive silica gel should be painted on IPM module (on the reverse side of the inverter module PCB). Refer to Figure 4-4.2.

Figure 4-4.4: Relay location of main PCB for refrigerant system  
Single phase 4/6/8/10kW unit

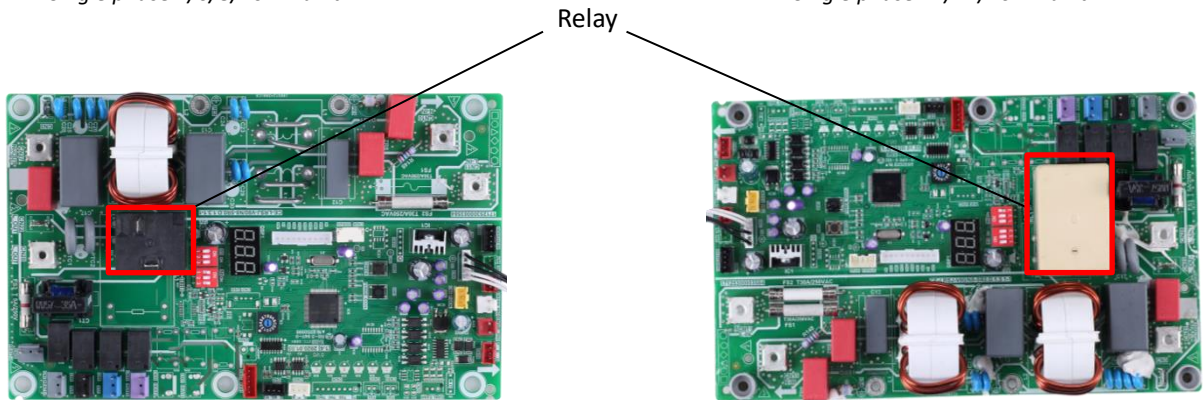

## 4.20.8 L5/L8/L9 troubleshooting

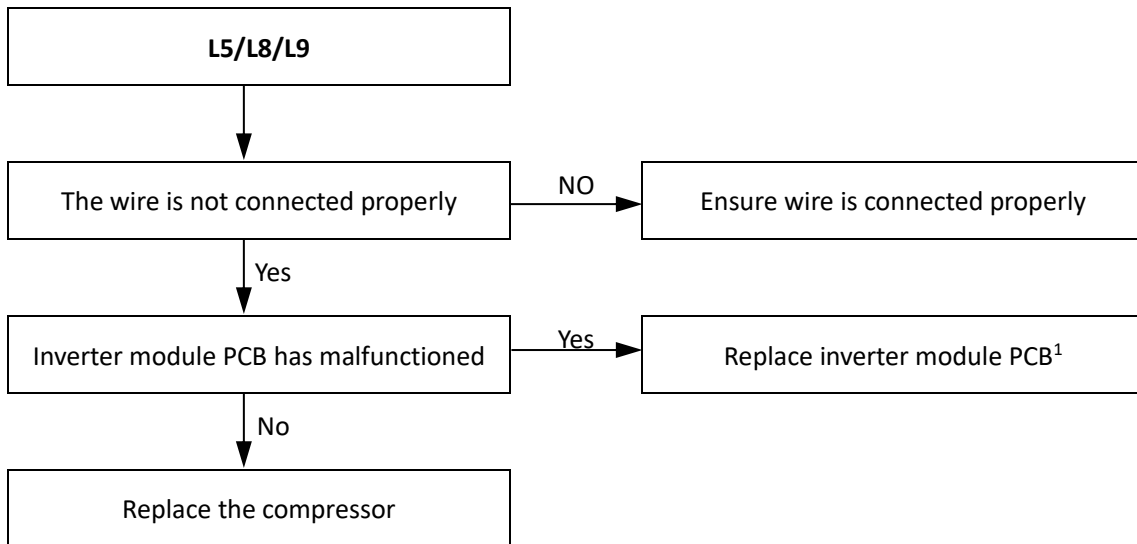

1. When replacing an inverter module, a layer of thermally conductive silica gel should be painted on IPM module (on the reverse side of the inverter module PCB). Refer to Figure 4-4.2.

## 4.21 Inverter module Troubleshooting for three-phase models

### 4.21.1 Digital display output

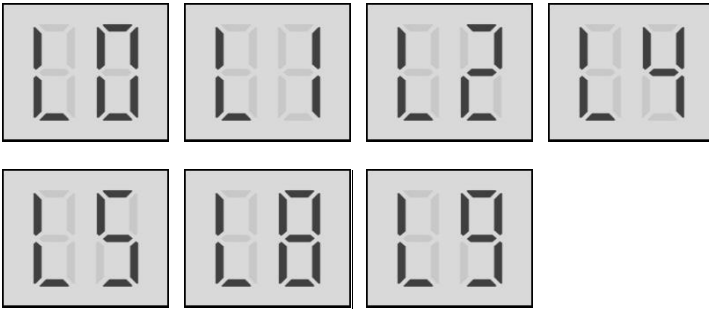

### 4.21.2 Description

- Inverter module protection or high pressure protection.
- OPTIMUS PRO Mono stops running.
- Specific error code L0, L1, L2, L4, L5, L8 , L9 is displayed on the user interface and the refrigerant system main PCB.

### 4.21.3 Possible causes

- Inverter module protection.
- DC bus low or high voltage protection.
- MCE error(DC bus low or high voltage protection or software over current protection)
- Zero speed protection.
- Excessive compressor frequency variation.
- Actual compressor frequency differs from target frequency.
- High pressure protection.Contactor stuck or 908 self checking fail.

### 4.21.4 Specific error codes for inverter module protection

Table 4-4.4: Specific error codes

Specific error code	Content
L0	Inverter module protection
L1	DC bus low voltage protection
L2	DC bus high voltage protection
L4	MCE error(DC bus low or high voltage protection or software over current protection)
L5	Zero speed protection
L8	Compressor frequency variation greater than 15Hz within one second protection
L9	Actual compressor frequency differs from target frequency by more than 15Hz protection



# OPTIMUS PRO Mono

The specific error codes can also be obtained from the LED indicators LED1/LED2 on the inverter module.

Table 4-4.5: Errors indicated on LED for three-phase 12~16kW unit

LED1/2 flashing pattern	Corresponding error
Flashes 8 times and stops for 1 second, then repeats	L0 - Inverter module protection
Flashes 9 times and stops for 1 second, then repeats	L1 - DC bus low voltage protection
Flashes 10 times and stops for 1 second, then repeats	L2 - DC bus high voltage protection
Flashes 12 times and stops for 1 second, then repeats	L4 - MCE error(DC bus low or high voltage protection or software over current protection)
Flashes 13 times and stops for 1 second, then repeats	L5 - Zero speed protection
Flashes 17 times and stops for 1 second, then repeats	L8 - Compressor frequency variation greater than 15Hz within one second protection L9 - Actual compressor frequency differs from target frequency by more than 15Hz protection
Flashes 3 times and stops for 1 second, then repeats	bH - Contactor stuck or 908 self checking fail
Flashes 5 times and stops for 1 second, then repeats	P1 - High pressure protection

Figure 4-4.5: LED location of inverter module for three-phase 12~16kW unit

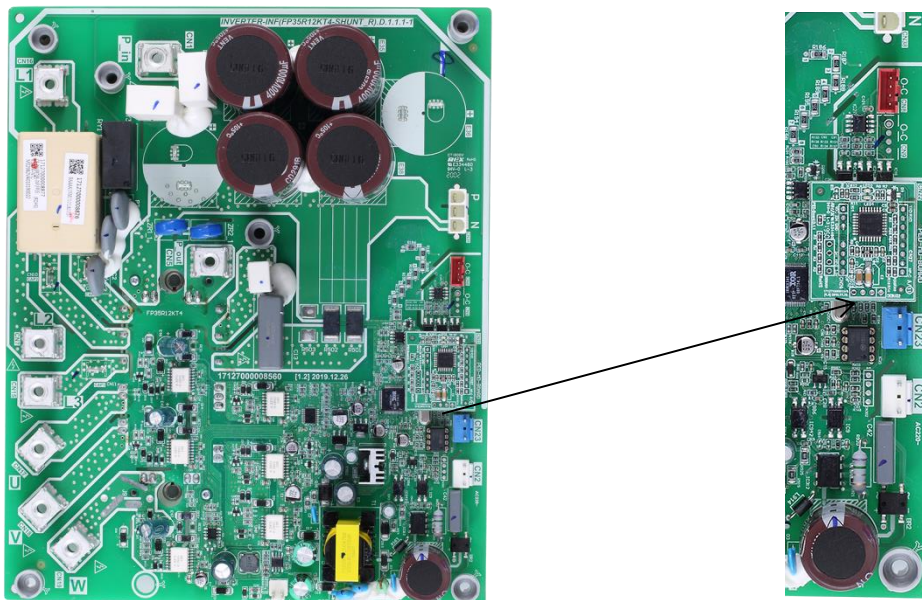

## 4.21.5 Principle of DC inverter

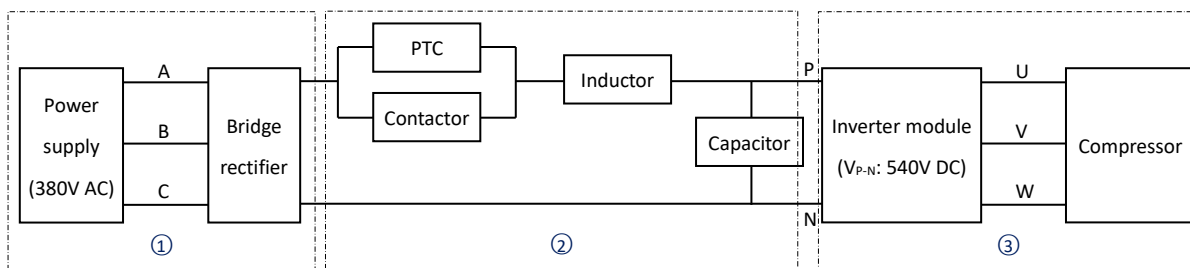

- ① 380-415V AC power supply change to DC power supply after bridge rectifier.
- ② Contactor is open the current across the PTC to charge capacitor, after 5 seconds the contactor closed.
- ③ The capacitor output steady 540V DC power supply for inverter module P N terminals.

4.21.6 L0 troubleshooting

Situation 1: L0 error appears immediately after the outdoor unit is powered-on

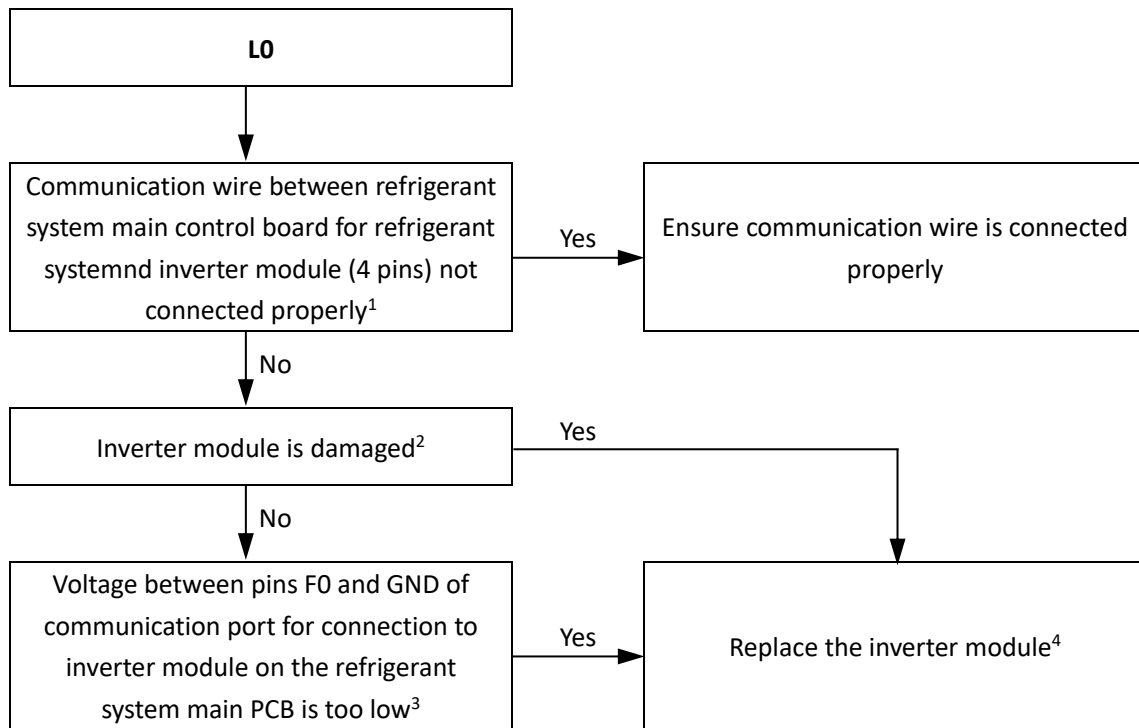

- Notes:
1. For HOP12(14,16)WMONO3, the communication port between refrigerant system main control board for refrigerant system inverter module is port CN36 on refrigerant system main control board for refrigerant system port CN8 on inverter module.
  2. Measure the resistance between each of U, V and W and each of P and N on the inverter module. All the resistances should be infinite. If any of them are not infinite, the inverter module is damaged and should be replaced.
  3. The normal voltage between F0 and GND is 5V. Refer to Figure 4-4.6.
  4. When replacing an inverter module, a layer of thermally conductive silica gel should be painted on the IPM module (on the reverse side of the inverter module PCB). Refer to Figure 4-4.2.

Figure 4-4.6: F0 and GND voltage on IC28-1 (F0), IC28-4 (GND)

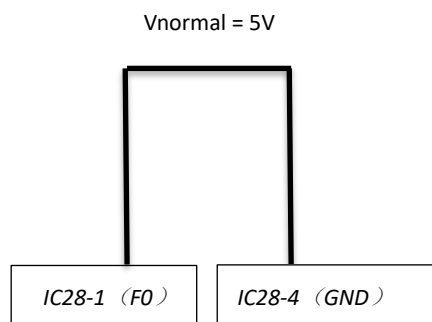

# OPTIMUS PRO Mono

## Situation 2: L0 error appears immediately after the compressor starts up

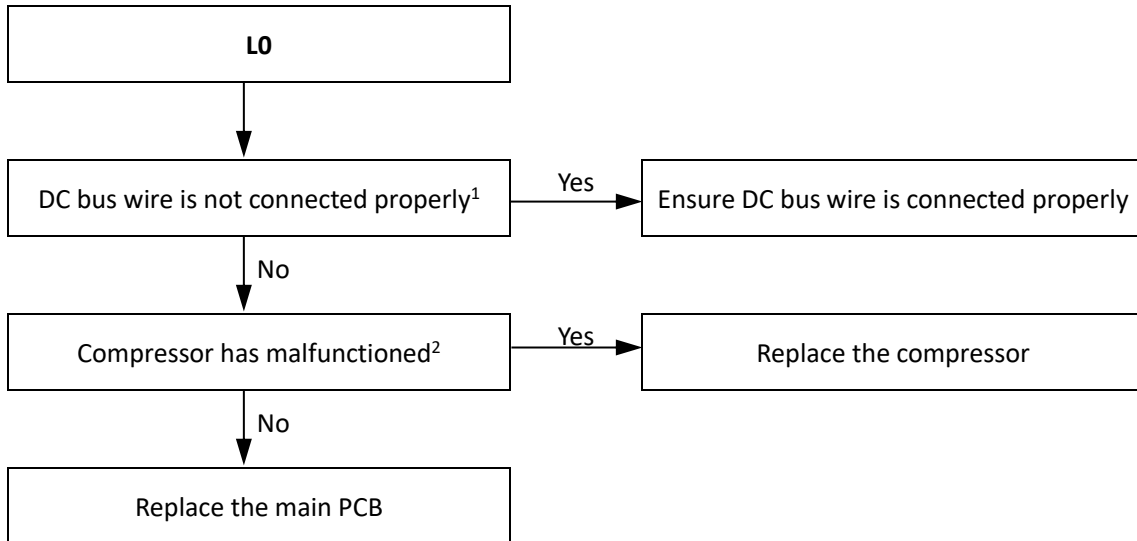

### Notes:

1. The DC bus wire should run from the N terminal on the inverter module, through the current sensor (in the direction indicated by the arrow on the current sensor), and end at the N terminal of capacitor. Refer to Figure 4-4.7.

Figure 4-4.7: DC bus wire connection (L1L2L3, PIN- POUT)

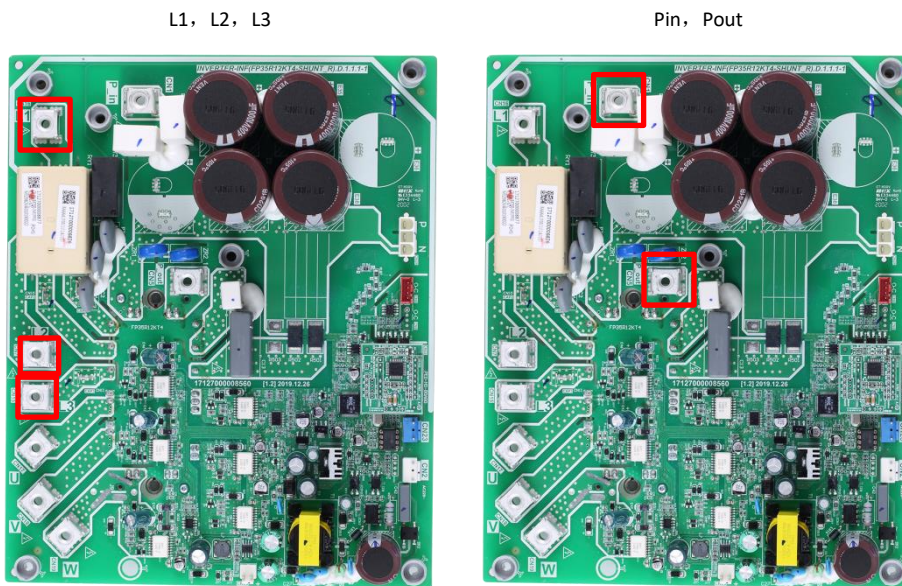

2. The normal resistances of the inverter compressor are 0.7-1.5Ω among U V W and infinite between each of U V W and ground. If any of the resistances differ from these specifications, the compressor has malfunctioned.

Situation 3: L0 error appears within 2 seconds of compressor start-up

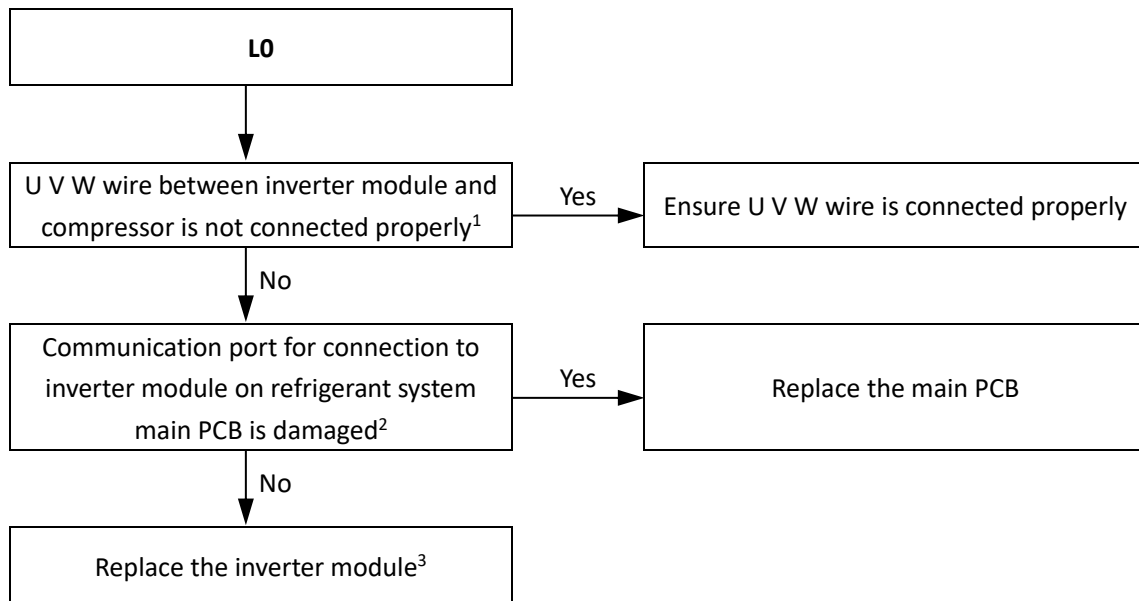

- Notes:
1. Connect the U V W wire from the inverter module to the correct compressor terminals, as indicated by the labels on the compressor.
  2. Measure the voltage between each of W-, W+, V-, V+, U-, U+ and GND when the unit is in standby. The normal voltage should be 2.5V-4V and the six voltages should be same, otherwise the communication terminal has failed. Refer to Figure4-4.8.

Figure 4-4.8: Connection port for inverter module

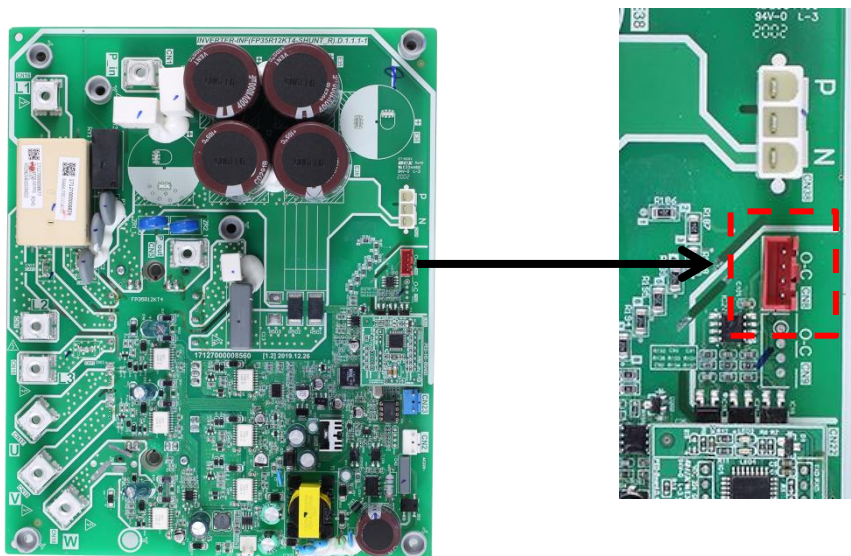

3. When replacing an inverter module, a layer of thermally conductive silica gel should be painted on the IPM module (on the reverse side of the inverter module PCB). Refer to Figure 4-4.2.

## OPTIMUS PRO Mono

Condition 4: L0 error appears after the compressor has been running for a period of time and the compressor speed is over 60rps

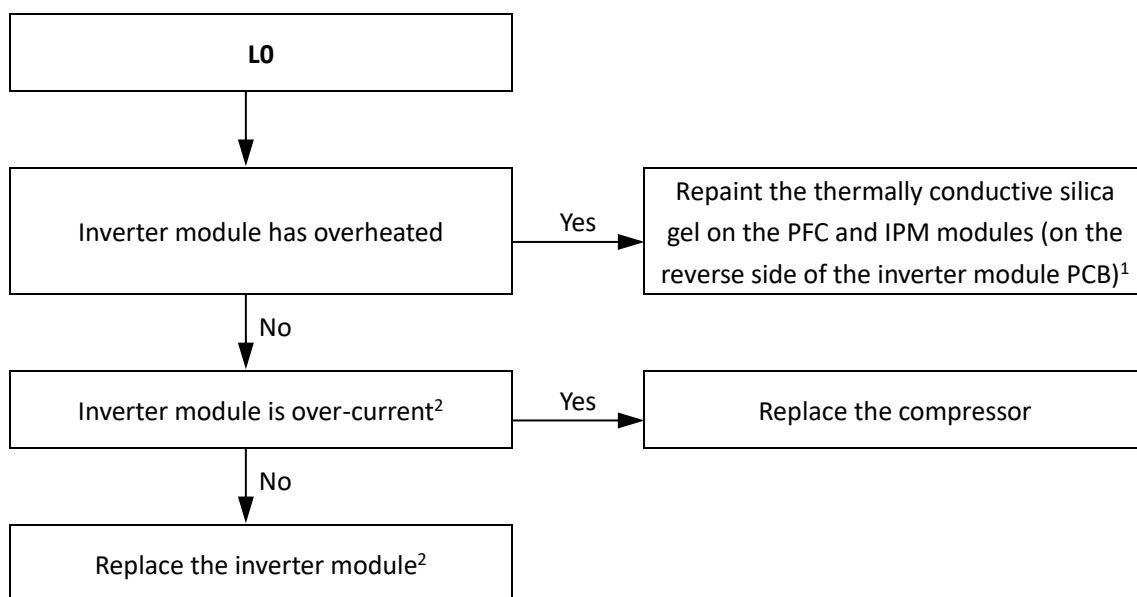

Notes:

1. When replacing an inverter module, a layer of thermally conductive silica gel should be painted on the IPM module (on the reverse side of the inverter module PCB).
2. Use clip-on ammeter to measure the compressor current, if the current is normal indicates the inverter module is failed, if the current is abnormal indicates the compressor has failed.

Situation 5: L0 error appears occasionally/irregularly

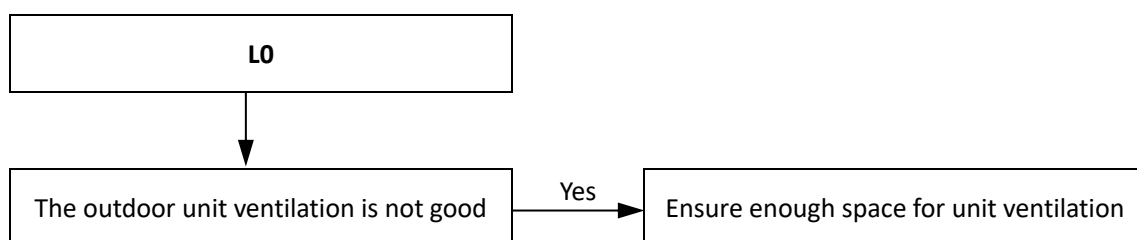

4.21.7 L1/L2 troubleshooting

The normal DC voltage between terminals P and N on inverter module is 540V. If the voltage is lower than 300V, the unit displays an L1 error; if the voltage is higher than 830V, the unit displays an L2 error. Refer to Figure4-4.9.

Figure 4-4.9: P, N terminals voltage

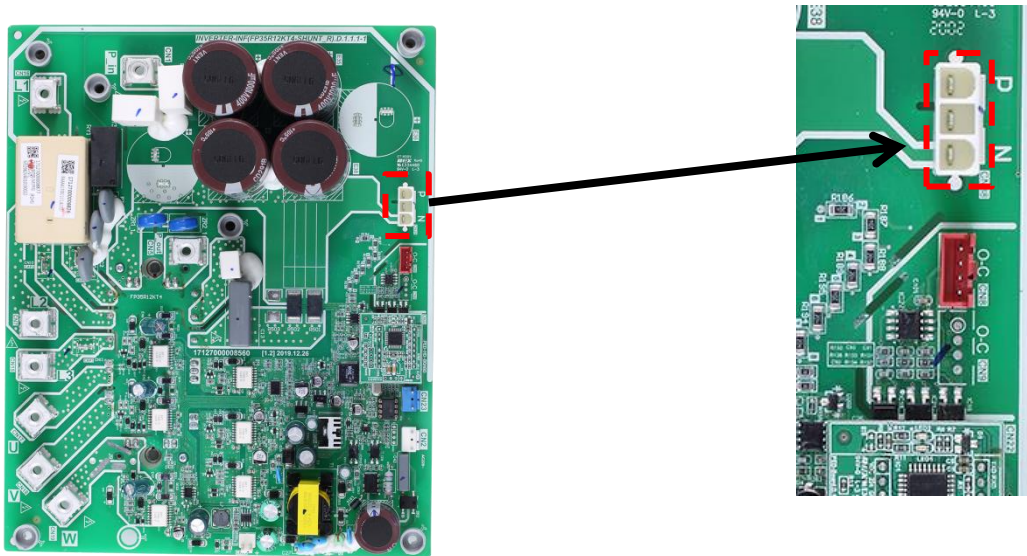

$V_{normal} = 540V DC$

Situation 1: L1 or L2 error appears immediately after the outdoor unit is powered-on

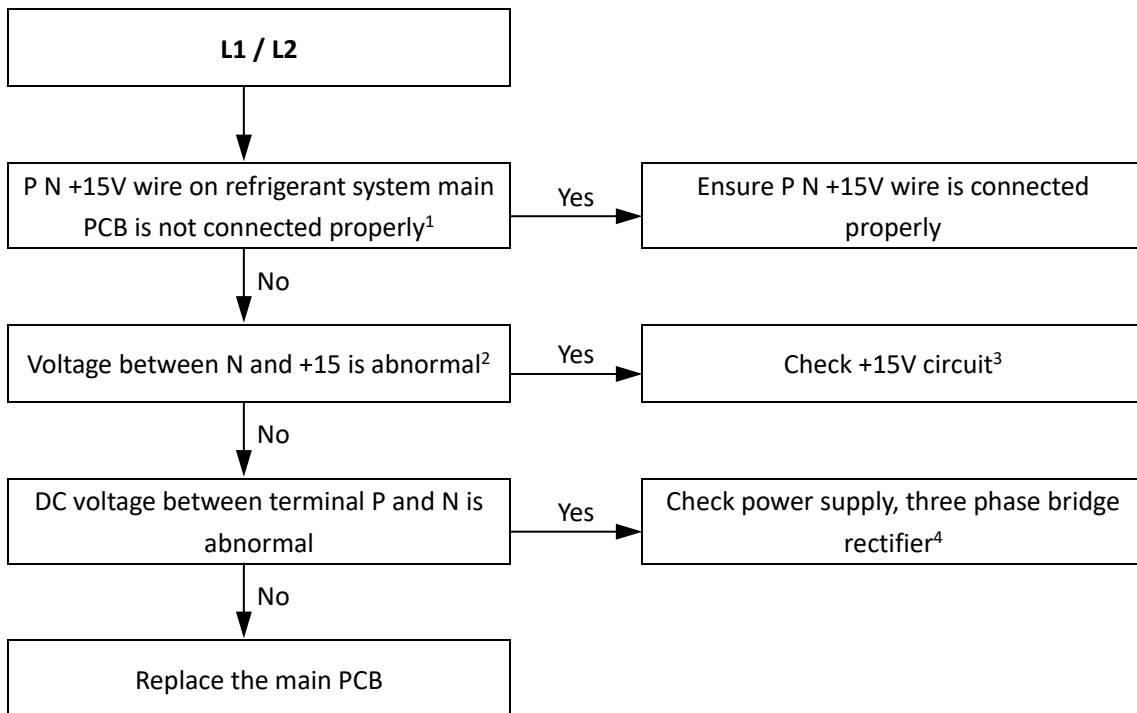

Notes:

1. P N +15V terminal on refrigerant system main PCB. Refer to Figure4-4.9.
2. Voltage between N and +15. Refer to Figure4-4.10



# OPTIMUS PRO Mono

Figure 4-4.10: P N +15V terminal+15V (IC4/5/6PIN12); N- (IC/4/5、6) PIN13

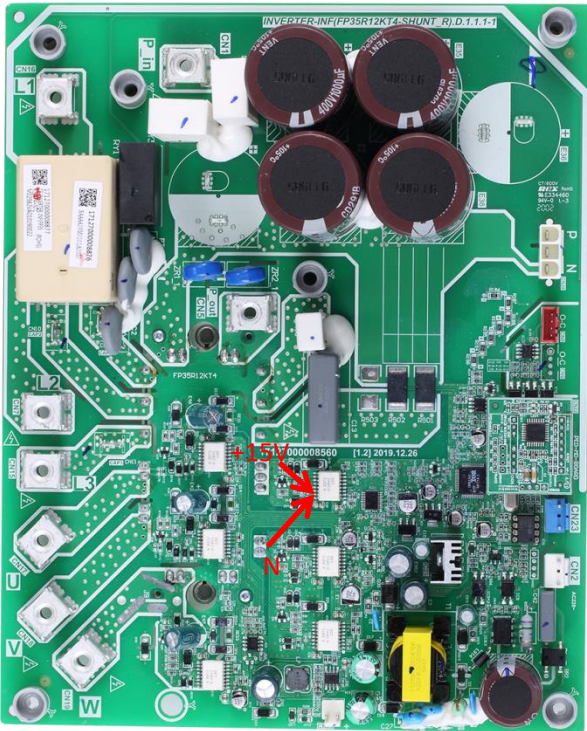

3. Check the +15V circuit according to corresponding wiring diagram. If IC4/5/6PIN12 on inverter module output voltage is not +15V means the inverter module is failed. If voltage output of inverter module is +15V means main PCB is failed.
4. Check the bridge rectifier using one of the following two methods (refer to Figure 4-4.11):
  - Method 1: measure the resistance between any two of the 5 bridge rectifier terminals. If any of the resistances is close to zero, the bridge rectifier has failed.
  - Method 2: dial a multimeter to the diode setting:
    - Put the red probe on the DC power output negative terminal (terminal 5) and put the black probe onto each of the AC power input terminals (terminals 1, 2 and 3) in turn. The voltage between terminal 5 and each of terminals 1, 2 and 3 should be around 0.378V. If the voltage is 0, the bridge rectifier has failed.
    - Put the red probe on the DC power output positive terminal (terminal 4), then put black probe onto each of the AC power input terminals (terminals 1, 2 and 3) in turn. The voltage between terminal 4 and each of terminals 1, 2 and 3 should be infinite. If the voltage is 0, the bridge rectifier has failed.

Figure 4-4.11: Bridge rectifier

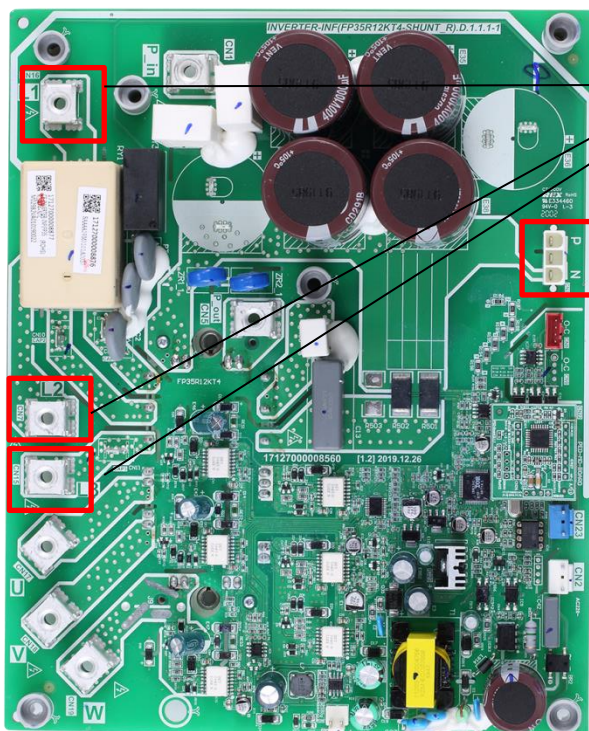

Three phase AC power input

DC power output

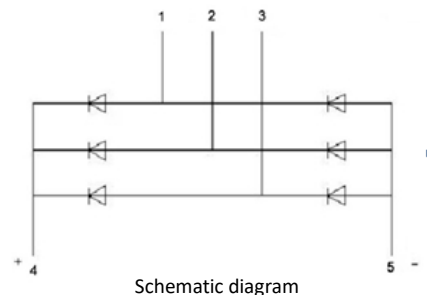



4.21.8 L4 troubleshooting(the same as L1/L2)

Situation 1: L4 error appears immediately after the outdoor unit is powered-on

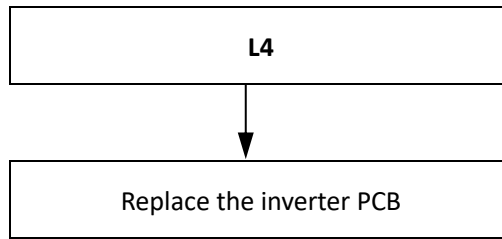

Condition 2: L4 error appears after the compressor has been running for a period of time and the compressor speed is over 60rps

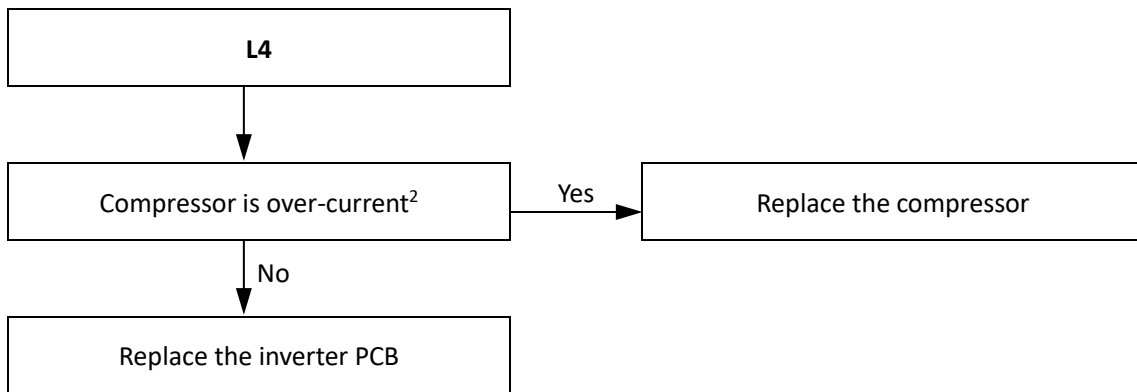

- Notes:
1. Re-start the unit, use clip-on ammeter to measure the compressor current, if the current is normal indicates the compressor is failed, if the current is abnormal indicates the inverter PCB is failed..

4.21.9 L5/L8/L9 troubleshooting

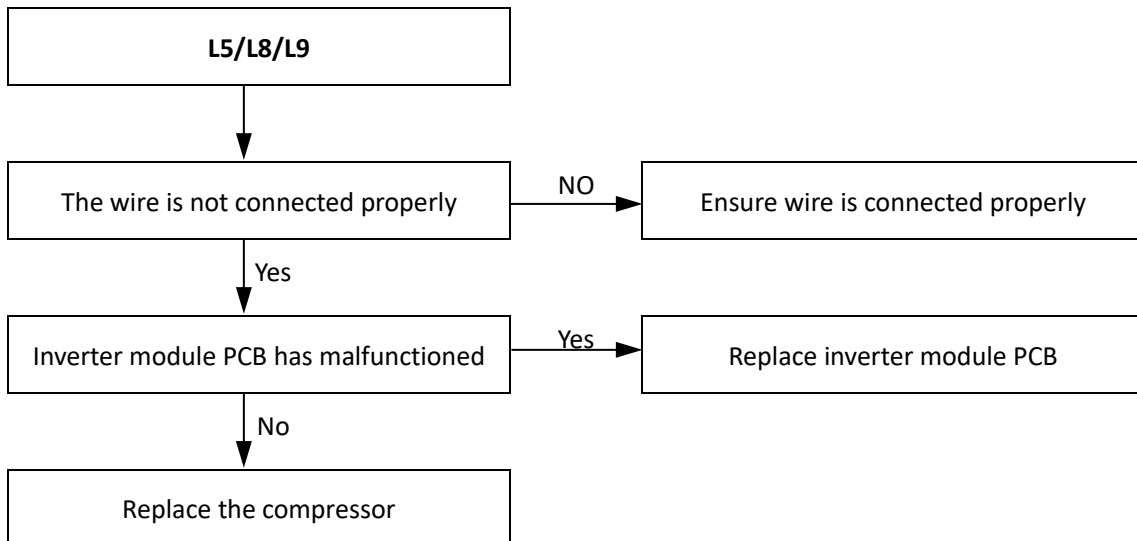

## 4.22 bH Troubleshooting

### 4.22.1 Digital display output

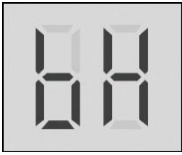

### 4.22.2 Description

- PED PCB failure
- OPTIMUS PRO Split stops running.
- Error code is displayed on hydronic box main PCB and user interface.

### 4.22.3 Possible causes

- Power supply problem.
- PED board broken.
- IPM module broken.

4.22.4 Procedure

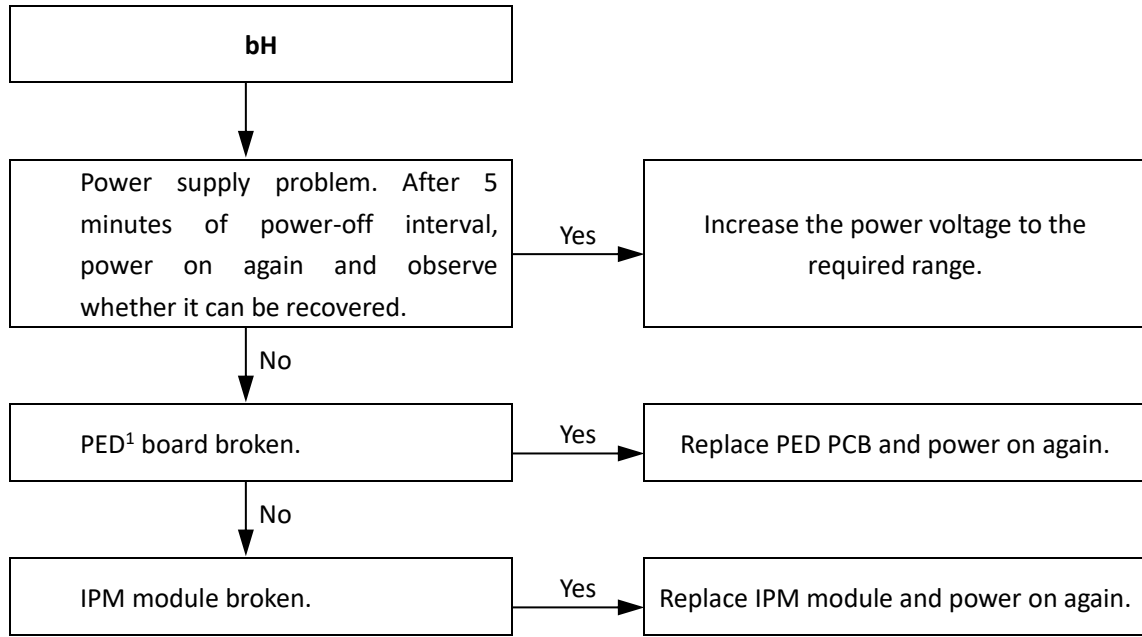

Notes:

1. PED is port CN22 on the hydronic box main PCB (labeled 11 in Figure 4-2.7: HOP12(14,16)WMONO3 outdoor unit inverter module ).

# OPTIMUS PRO Mono

## 4.23 Pb Troubleshooting

### 4.23.1 Digital display output



### 4.23.2 Description

- Water side heat exchanger anti-freeze protection.
- OPTIMUS PRO Mono stops running.
- Error code is displayed on refrigerant system main control board for refrigerant system and **ANTI.FREEZE** icon is displayed on user interface.

### 4.23.3 Possible causes

- Normal system protection.
- Temperature sensor not connected properly or has malfunctioned.
- Hydronic system main PCB damaged.

### 4.23.4 Procedure

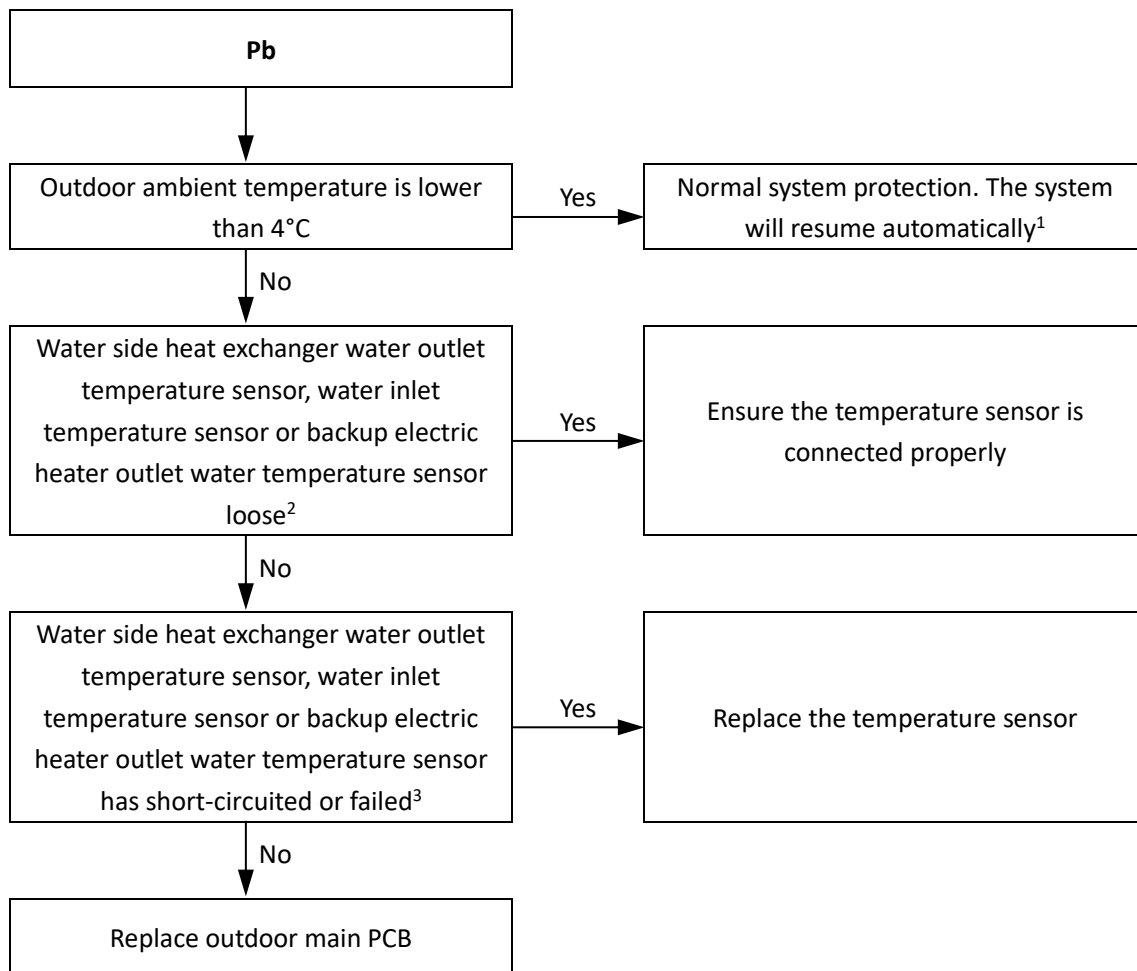

#### Notes:

1. Refer to Part 3, 5.7 "Water Side Heat Exchanger Anti-freeze Protection Control".
2. Backup electric heater water outlet temperature sensor, water side heat exchanger water inlet temperature sensor and water side heat exchanger water outlet temperature sensor connections are port CN6 on the hydronic system main PCB (labeled 8 in Figure 4-2.1 in Part 4, 2.2 "Main PCB for Hydronic System").
3. Measure sensor resistance. If the resistance is too low, the sensor has short-circuited. If the resistance is not consistent with the sensor's resistance characteristics table, the sensor has failed. Refer to Part 2, 1 "Layout of Functional Components" and to Table 4-5.3 in Part 4, 5.1 "Temperature Sensor Resistance Characteristics".

## 4.24 Pd Troubleshooting

### 4.24.1 Digital display output



### 4.24.2 Description

- High temperature protection of air side heat exchanger refrigerant outlet in cooling mode. When the air side heat exchanger refrigerant outlet temperature is higher than 61°C for more than 3 seconds, the system displays Pd protection and OPTIMUS PRO Mono stops running. When the air side heat exchanger refrigerant outlet temperature returns drops below 55°C, Pd is removed and normal operation resumes.
- OPTIMUS PRO Mono stops running.
- Error code is displayed on refrigerant system main control board for refrigerant system and user interface.

### 4.24.3 Possible causes

- Temperature sensor not connected properly or has malfunctioned.
- Poor condenser heat exchange.
- Fan motor damaged.
- Hydronic system main PCB damaged.

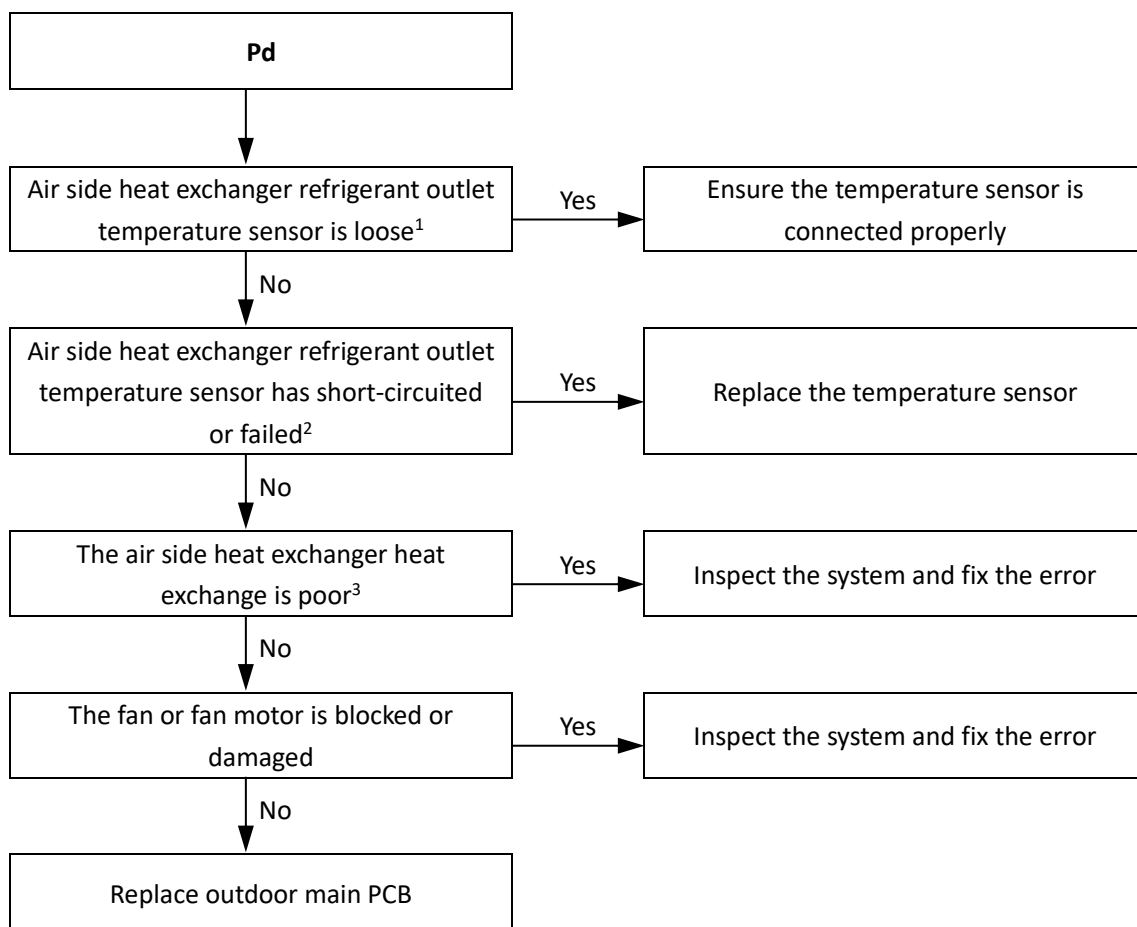

Notes:

1. Air side heat exchanger refrigerant outlet temperature sensor and outdoor ambient temperature sensor connections are port CN9 on the refrigerant system main PCB (labeled 12 in Figure 4-2.2 in Part 4, 2.3 "Main PCBs for Refrigerant System, Inverter Modules and Filter Boards", (labeled 5 in Figure 4-2.4 in Part 4, 2.3 "Main PCBs for Refrigerant System, Inverter Modules and Filter Boards" and labeled 6 in Figure 4-2.6 in Part 4, 2.3 "Main PCBs for Refrigerant System, Inverter Modules and Filter Boards").
2. Measure sensor resistance. If the resistance is too low, the sensor has short-circuited. If the resistance is not consistent with the sensor's resistance characteristics table, the sensor has failed. Refer to Part 2, 1 "Layout of Functional Components" and to Table 4-5.1 in Part 4, 5.1 "Temperature Sensor Resistance Characteristics".
3. Check air side heat exchanger, fan(s) and air outlets for dirt/blockages.

## 4.25 PP Troubleshooting

### 4.25.1 Digital display output

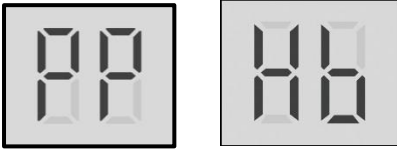

### 4.25.2 Description

- Water side heat exchanger inlet temperature is higher than outlet temperature in heating mode.
- OPTIMUS PRO Mono stops running.
- Error code is displayed on hydronic system main control board for refrigerant system and user interface.
- If PP error occurs 3 times then Hb will appear.

### 4.25.3 Possible causes

- Temperature sensor not connected properly or has malfunctioned.
- 4-way valve is blocked or damaged.
- Hydronic system main PCB damaged.

## 4.25.4 Procedure

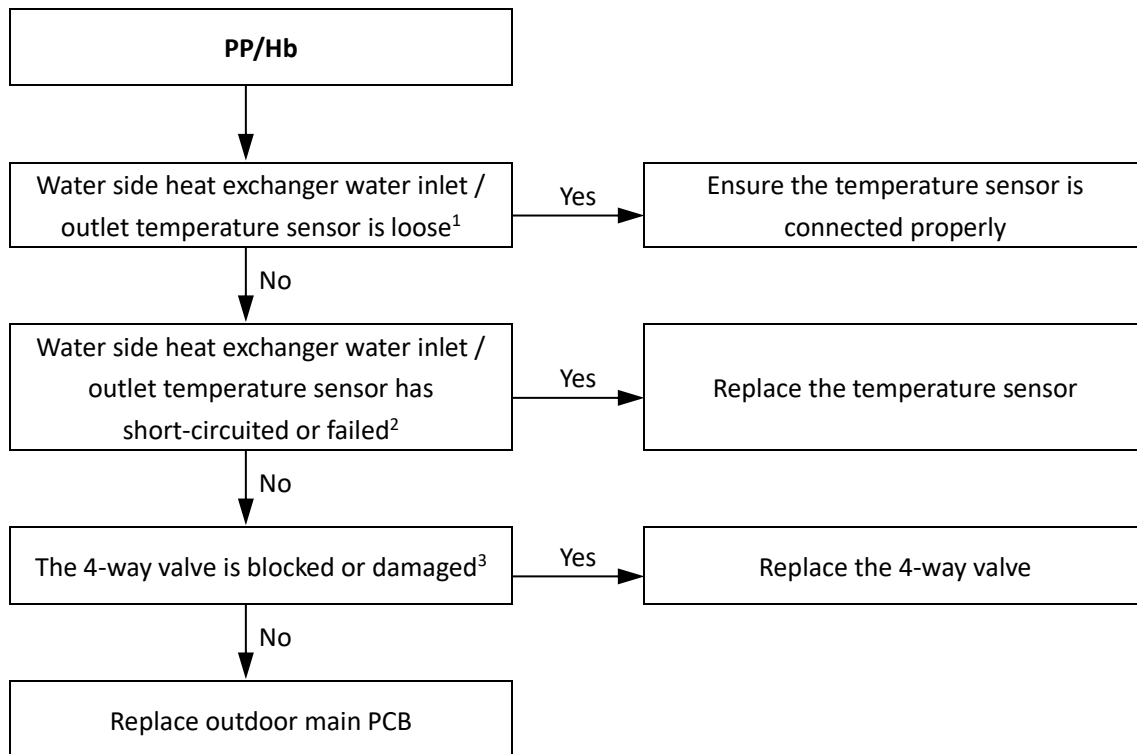

Notes:

1. Water side heat exchanger water inlet temperature sensor and water side heat exchanger water outlet temperature sensor connections are port CN6 on the hydronic system main PCB (labeled 8 in Figure 4-2.1 in Part 4, 2.2 “Min PCB for Hydronic System”).
2. Measure sensor resistance. If the resistance is too low, the sensor has short-circuited. If the resistance is not consistent with the sensor’s resistance characteristics table, the sensor has failed. Refer to Part 2, 1 “Layout of Functional Components” and to Table 4-5.1 to 4-5.2 in Part 4, 5.1 “Temperature Sensor Resistance Characteristics”.
3. Restart the unit in cooling mode to change the refrigerant flow direction. If the unit does not operate normally, the 4-way valve is blocked or damaged.



## 4.26 HE Troubleshooting

### 4.26.1 Digital display output



### 4.26.2 Description

- Communication error between main control board of hydronic module and Ta/room thermostat transfer PCB
- OPTIMUS PRO Mono stops running.
- Error code is displayed on hydronic system main PCB, outdoor unit main PCB and user interface.

### 4.26.3 Possible causes

- Temperature collecting plate(Optional) connection wire is not connected.
- Temperature collecting plate(Optional) is damaged.

### 4.26.4 Procedure

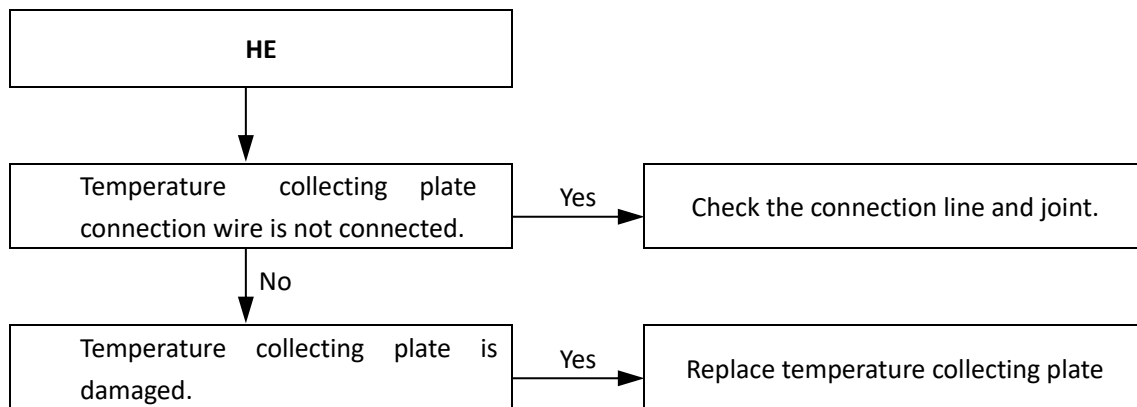

# OPTIMUS PRO Mono

## 4.27 Hd Troubleshooting

### 4.27.1 Digital display output



### 4.27.2 Description

- Communication fault between master unit and slave unit (in parallel)
- OPTIMUS PRO Mono stops running.
- Error code is displayed on hydronic system main PCB, outdoor unit main PCB and user interface.

### 4.27.3 Possible causes

- SW9 DIP switch with wrong settings
- More than two units are connected to the wire controller
- Power-on interval between master unit and slave unit is longer than 2min
- Wire connection error
- Communication between units is unstable
- Address code missing or address code setting duplicate
- Main board fuse is damaged

### 4.27.4 Procedure

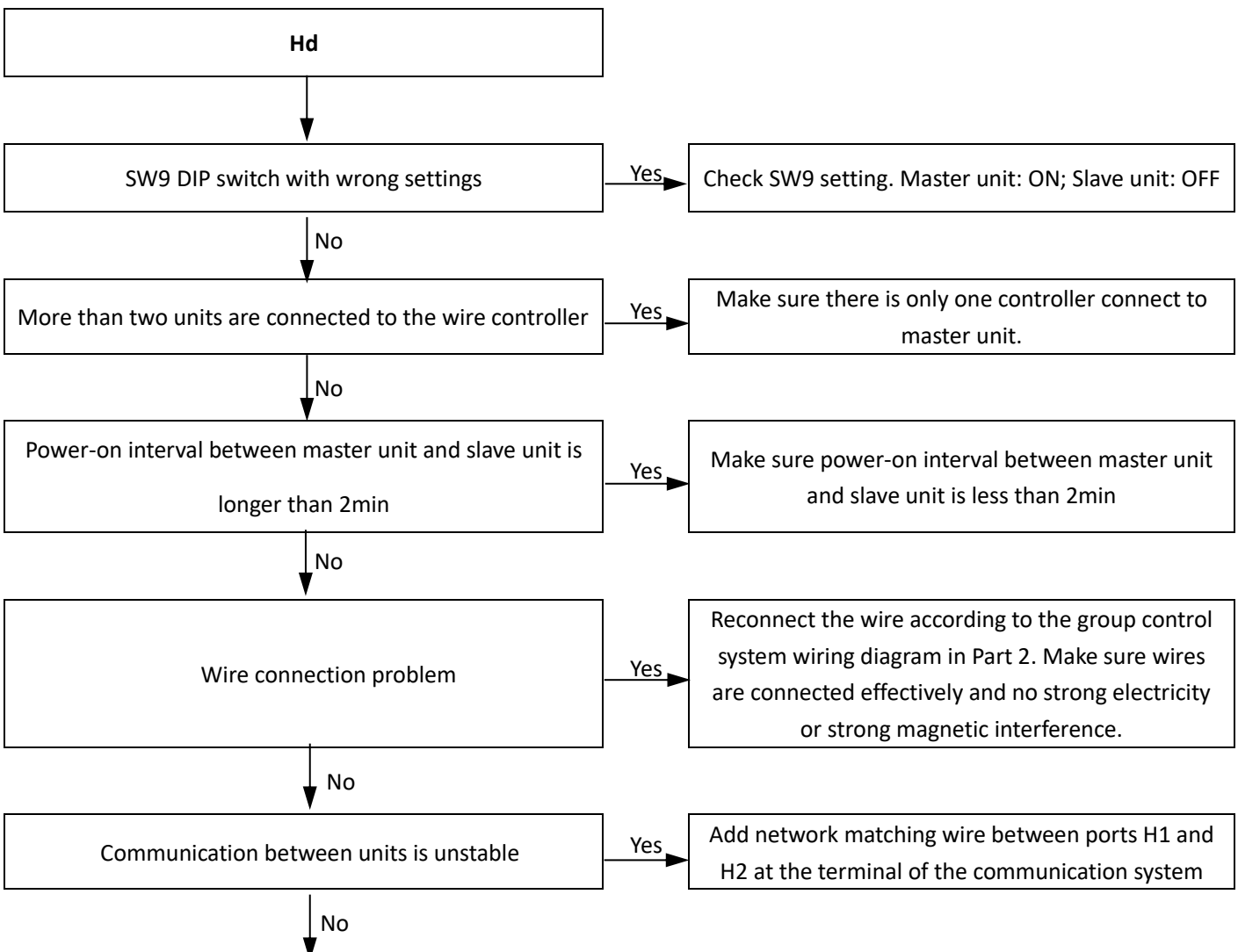

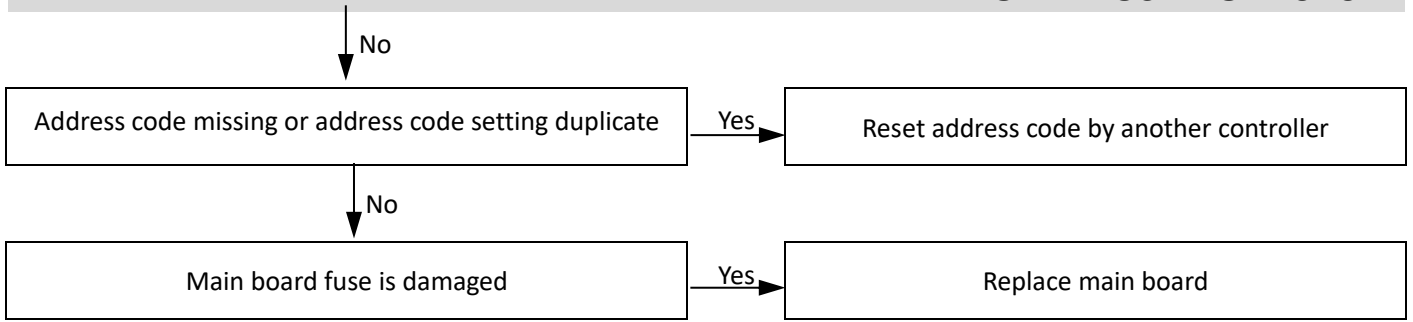

# OPTIMUS PRO Mono

## 5 Appendix to Part 4

### 5.1 Temperature Sensor Resistance Characteristics

Table 4-5.1: Outdoor ambient temperature sensor, water side heat exchanger refrigerant inlet / outlet (liquid / gas pipe) temperature sensor, air side heat exchanger refrigerant out temperature sensor and suction pipe temperature sensor resistance characteristics

Temperature (°C)	Resistance (kΩ)	Temperature (°C)	Resistance (kΩ)	Temperature (°C)	Resistance (kΩ)	Temperature (°C)	Resistance (kΩ)
-25	144.266	15	16.079	55	2.841	95	0.708
-24	135.601	16	15.313	56	2.734	96	0.686
-23	127.507	17	14.588	57	2.632	97	0.666
-22	119.941	18	13.902	58	2.534	98	0.646
-21	112.867	19	13.251	59	2.44	99	0.627
-20	106.732	20	12.635	60	2.35	100	0.609
-19	100.552	21	12.05	61	2.264	101	0.591
-18	94.769	22	11.496	62	2.181	102	0.574
-17	89.353	23	10.971	63	2.102	103	0.558
-16	84.278	24	10.473	64	2.026	104	0.542
-15	79.521	25	10	65	1.953	105	0.527
-14	75.059	26	9.551	66	1.883		
-13	70.873	27	9.125	67	1.816		
-12	66.943	28	8.721	68	1.752		
-11	63.252	29	8.337	69	1.69		
-10	59.784	30	7.972	70	1.631		
-9	56.524	31	7.625	71	1.574		
-8	53.458	32	7.296	72	1.519		
-7	50.575	33	6.982	73	1.466		
-6	47.862	34	6.684	74	1.416		
-5	45.308	35	6.401	75	1.367		
-4	42.903	36	6.131	76	1.321		
-3	40.638	37	5.874	77	1.276		
-2	38.504	38	5.63	78	1.233		
-1	36.492	39	5.397	79	1.191		
0	34.596	40	5.175	80	1.151		
1	32.807	41	4.964	81	1.113		
2	31.12	42	4.763	82	1.076		
3	29.528	43	4.571	83	1.041		
4	28.026	44	4.387	84	1.007		
5	26.608	45	4.213	85	0.974		
6	25.268	46	4.046	86	0.942		
7	24.003	47	3.887	87	0.912		
8	22.808	48	3.735	88	0.883		
9	21.678	49	3.59	89	0.855		
10	20.61	50	3.451	90	0.828		
11	19.601	51	3.318	91	0.802		
12	18.646	52	3.191	92	0.777		
13	17.743	53	3.069	93	0.753		
14	16.888	54	2.952	94	0.73		

Table 4-5.2: Compressor discharge pipe temperature sensor resistance characteristics

Temperature (°C)	Resistance (kΩ)	Temperature (°C)	Resistance (kΩ)	Temperature (°C)	Resistance (kΩ)	Temperature (°C)	Resistance (kΩ)
-20	542.7	20	68.66	60	13.59	100	3.702
-19	511.9	21	65.62	61	13.11	101	3.595
-18	483.0	22	62.73	62	12.65	102	3.492
-17	455.9	23	59.98	63	12.21	103	3.392
-16	430.5	24	57.37	64	11.79	104	3.296
-15	406.7	25	54.89	65	11.38	105	3.203
-14	384.3	26	52.53	66	10.99	106	3.113
-13	363.3	27	50.28	67	10.61	107	3.025
-12	343.6	28	48.14	68	10.25	108	2.941
-11	325.1	29	46.11	69	9.902	109	2.860
-10	307.7	30	44.17	70	9.569	110	2.781
-9	291.3	31	42.33	71	9.248	111	2.704
-8	275.9	32	40.57	72	8.940	112	2.630
-7	261.4	33	38.89	73	8.643	113	2.559
-6	247.8	34	37.30	74	8.358	114	2.489
-5	234.9	35	35.78	75	8.084	115	2.422
-4	222.8	36	34.32	76	7.820	116	2.357
-3	211.4	37	32.94	77	7.566	117	2.294
-2	200.7	38	31.62	78	7.321	118	2.233
-1	190.5	39	30.36	79	7.086	119	2.174
0	180.9	40	29.15	80	6.859	120	2.117
1	171.9	41	28.00	81	6.641	121	2.061
2	163.3	42	26.90	82	6.430	122	2.007
3	155.2	43	25.86	83	6.228	123	1.955
4	147.6	44	24.85	84	6.033	124	1.905
5	140.4	45	23.89	85	5.844	125	1.856
6	133.5	46	22.89	86	5.663	126	1.808
7	127.1	47	22.10	87	5.488	127	1.762
8	121.0	48	21.26	88	5.320	128	1.717
9	115.2	49	20.46	89	5.157	129	1.674
10	109.8	50	19.69	90	5.000	130	1.632
11	104.6	51	18.96	91	4.849		
12	99.69	52	18.26	92	4.703		
13	95.05	53	17.58	93	4.562		
14	90.66	54	16.94	94	4.426		
15	86.49	55	16.32	95	4.294		
16	82.54	56	15.73	96	4.167		
17	78.79	57	15.16	97	4.045		
18	75.24	58	14.62	98	3.927		
19	71.86	59	14.09	99	3.812		

# OPTIMUS PRO Mono

Table 4-5.3: Water side heat exchanger water inlet / outlet temperature sensor, final outlet water temperature sensor and DHW temperature sensor resistance characteristics

Temperature (°C)	Resistance (kΩ)	Temperature (°C)	Resistance (kΩ)	Temperature (°C)	Resistance (kΩ)	Temperature (°C)	Resistance (kΩ)
-30	867.29	10	98.227	50	17.600	90	4.4381
-29	815.80	11	93.634	51	16.943	91	4.3022
-28	767.68	12	89.278	52	16.315	92	4.1711
-27	722.68	13	85.146	53	15.713	93	4.0446
-26	680.54	14	81.225	54	15.136	94	3.9225
-25	641.07	15	77.504	55	14.583	95	3.8046
-24	604.08	16	73.972	56	14.054	96	3.6908
-23	569.39	17	70.619	57	13.546	97	3.5810
-22	536.85	18	67.434	58	13.059	98	3.4748
-21	506.33	19	64.409	59	12.592	99	3.3724
-20	477.69	20	61.535	60	12.144	100	3.2734
-19	450.81	21	58.804	61	11.715	101	3.1777
-18	425.59	22	56.209	62	11.302	102	3.0853
-17	401.91	23	53.742	63	10.906	103	2.9960
-16	379.69	24	51.396	64	10.526	104	2.9096
-15	358.83	25	49.165	65	10.161	105	2.8262
-14	339.24	26	47.043	66	9.8105		
-13	320.85	27	45.025	67	9.4736		
-12	303.56	28	43.104	68	9.1498		
-11	287.33	29	41.276	69	8.8387		
-10	272.06	30	39.535	70	8.5396		
-9	257.71	31	37.878	71	8.2520		
-8	244.21	32	36.299	72	7.9755		
-7	231.51	33	34.796	73	7.7094		
-6	219.55	34	33.363	74	7.4536		
-5	208.28	35	31.977	75	7.2073		
-4	197.67	36	30.695	76	6.9704		
-3	187.66	37	29.453	77	6.7423		
-2	178.22	38	28.269	78	6.5228		
-1	168.31	39	27.139	79	6.3114		
0	160.90	40	26.061	80	6.1078		
1	152.96	41	25.031	81	5.9117		
2	145.45	42	24.048	82	5.7228		
3	138.35	43	23.109	83	5.5409		
4	131.64	44	22.212	84	5.3655		
5	125.28	45	21.355	85	5.1965		
6	119.27	46	20.536	86	5.0336		
7	113.58	47	19.752	87	4.8765		
8	108.18	48	19.003	88	4.7251		
9	103.07	49	18.286	89	4.5790		

